



SCE1350A-EV

Crawler Crane

135 Tons Lifting Capacity

Quality Changes the World



- Max. lifting capacity: 135t**
- Max. boom length: 76m**
- Max. fixed jib combination: 61m+31m**
- Max. luffing jib combination: 49m+52m**

The parameters, pictures and standard/optional equipment are only for reference in this brochure, the actual machine is based on the effective price list and contract.



Pure electric crawler crane series
SCE1350A-EV

P03

Main
Characteristics

- Product Specification
- Safety Device

P09

Technical
Parameters

- Major Performance & Specifications
- Outline Dimension
- Transport Dimension
- Transport Plan

P19

Configurations

- Boom / Jib Combination
- H Configuration
- FJ Configuration
- LJ Configuration
- LJCZG Configuration



SCE1350A-EV
SANY PURE ELECTRIC CRAWLER CRANE
135 TONS LIFTING CAPACITY

QUALITY CHANGES THE WORLD

Main Characteristics

- Page 04 Product Specification
- Page 07 Safety Device



Product Specification



Battery

- Type: CATL LFP (Lithium Iron Phosphate);
- Gross battery capacity: 368kWh.

Drive Motor

- Model: EM-PMI375-T1100;
- Type: Three-phase AC permanent magnet synchronous motor;
- Rated voltage: 500V AC;
- Average efficiency: 96%;
- Rated power: 206kW;
- Rated speed: 1500rpm;
- Rated torque: 1310N·m;
- Max. power: 336kW;
- Max. speed: 2570rpm;
- Max. torque: 2500N·m;
- Weight: 295kg;
- Max. ambient temperature: 65°C;
- Min. ambient temperature: -40°C;
- Max. inlet temperature: 65°C;
- Cooling system: Water cooling, external switch unit;
- Protection level: IP67.

Electric Control System

- SANY Developed SYIC-III Integrated Control System;
- Control system consists of power system, electric motor system, main control system, LMI system, auxiliary system and safety monitoring system. CAN BUS is used for data communication between controller, monitor and the engine;
- Monitor: the working parameters and status are shown on the monitor, such as the motor speed, battery capacity, hydraulic system pressure, vehicle working time, lifting weight and boom angle.

Hydraulic System

- Main pumps: three open variable displacement piston pumps are adopted to provide oil supply for main actuators of main machine;
- Gear pump: two types of gear pump for radiator and control circuit;
- Control: main pump adopts Electricly-controlled positive flow control; winch motor adopts limitless adjustable piston motor of variable displacement. The operating components are two cross control handles for controlling each actuator;
- Way of cooling: heat exchanger, fan core and multi-stage cooling;
- Filter: large flow, high accuracy filter, with bypass valve and indicator, which can remind the user to replace the filter element in time;
- Max. pressure of system: 32MPa;
- Main/aux. load hoist and travel system: 32MPa;
- Swing system: 32MPa;
- Control system: 5MPa;
- Hydraulic Tank Capacity: 460L.

Main and Aux. Load Hoist Mechanism

- Main and aux. hoist winches are driven separately by motor via gearbox. Operating winch handle can control the winch to rotate to two directions, which are lifting and lowering of hook. Excellent inching function is equipped on the machine;
- Drums with fold-line grooves can ensure the wire rope reeved in order in multilayers;
- Non free fall for main/aux. load hoist:

Main Hoisting Mechanism	Drum diameter	630mm
	Rope speed (1st layer)	0~121m/min
	Diameter of wire rope	26mm
	Main load hoist wire rope length	300m
	Rated single line pull	12t
Auxiliary Hoisting Mechanism	Drum diameter	630mm
	Rope speed (1st layer)	0~121m/min
	Diameter of wire rope	26mm
	Auxiliary load hoist wire rope length	260m
	Rated single line pull	12t



Product Specification

- Free fall for main/aux. load hoist:

Main hoisting mechanism	Drum diameter	576mm
	Rope speed (1st layer)	0~121m/min
	Wire rope diameter	26mm
	Main hoist wire rope length	300mm
	Rated single line pull	12t
Aux. hoisting mechanism	Drum diameter	576mm
	Rope speed (1st layer)	0~121m/min
	Wire rope diameter	26mm
	Aux. hoist wire rope length	260mm
	Rated single line pull	12t

Boom Hoist Mechanism

- Boom hoist winch is driven directly by motor via gearbox. Operating winch handle can control the winch to rotate to two directions, which are lifting and lowering of boom;
- Drums with fold-line grooves can ensure the wire rope reeved in order in multilayers.

Boom hoist mechanism	Drum diameter	420mm
	Rope speed (1st layer)	0~45m/min
	Diameter of wire rope	20mm
	Boom hoist wire rope length	195m

Swing Mechanism

- Swing brake adopts wet, spring loaded, normally-closed brake, and braking through spring force;
- Swing system has three work modes to accommodate different needs. It is featured in small backlash, steady control, and excellent inching function. It also has free slipping function to avoid sudden braking;
- Swing drive: external engaged swing drive with 360° swing range, and the max. swing speed is 2.2r/min. The max. drive pressure can reach 32MPa;
- Swing ring: three-row roller bearing.

Cab and Control

- C6 operator's cab with fashionable profile, nice interior and large window glass, which can tilt up by 20° to provide panorama view. There are low and high-beam lights, back-view mirror, heater and A/C, radio and other functions. The layout of seat, handles, control buttons are designed with ergonomic principles to make operation more comfortable;
- Cab layout: Integrated 10.4-inch touch screen, programmable smart switches, vibration handles are offered as optional and man-machine interaction interface are more perfect;
- Armrest box: on the left and right armrest box are control handles, Electric switches, emergent stop and ignition switch. The armrest box can be adjusted along with the seat;
- Seat: multi-way and multi-level floating adjustable seat with unload switch;
- A/C: cool and heat air; optimized air channels and vents;
- Multiple cameras can present on the monitor at the same time to realize backing video, real-time monitoring of wire rope on each winch, conditions behind the counterweight and surrounding the machine.

Counterweight

- The stacking mode of counterweight tray and blocks is used for easy assembly, disassembly and transportation;
- Rear counterweight: Total weight 52t, 5t counterweight blocks ×8, 12t counterweight tray×1;
- Carbody counterweight: A total of 2, total weight of 20t (10t×2);
- Rear counterweight self-assembly device is offered as optional.

Upperworks

- High-strength steel weld framework, with no torsion or deformation. The parts are laid out in the way that is easier for maintenance and service.

Product Specification



Lowerworks

- Independent travel driving units are adopted for each side of the crawler, to realize straight walking and turning driven by travel motor through gearbox and drive wheel.

Crawler Tightening

- The track assembly is tensited by beating butter. In the working state, the spring provides buffer function to reduce the instant impact on the track and effectively avoid the track plate derailment and damage phenomenon.

Track Pad

- High strength chain rail flat track plate developed specifically for the European market;
- They are 950mm wide with a quantity of 73 pads×2.

Operating Equipment

- All chords are high-strength steel tubes, and the boom/jib top sheaves are made of high-strength anti-wearing Nylon material protecting wire rope. The hooks are installed with milled welded steel sheave.

Boom

- Lattice structure. The chord adopts high-strength structural tube and each section is connected through pins;
- Basic boom: 8m boom base+8m boom top;
- Boom insert: 3m×1, 6m×2, 9m×5;
- Boom length: 16m~76m.

Fixed Jib

- Lattice structure. The chord adopts high-strength structural tube and each section is connected through pins;
- Basic jib: 5m jib base +3m insert +5m jib top;
- Jib insert: 6m×3;
- Fixed jib length: 13~31m;
- Longest boom + jib: 61m+31m.

Luffing Jib

- Lattice structure. The chord adopts high-strength structural tube and each section is connected through pins;
- Basic jib: 6.5m jib base+9m insert+6.5m jib top;
- Jib insert: 3m×2, 6m×1, 9m×2;
- Luffing jib length: 22m~52m;
- Longest boom + jib: 49m+52m.

Extension Jib

- The welding structure is connected with main boom through hinge pin, and used for aux. hook operation;
- Length of extension boom: 2.7m.

Hook Block

- 135t hook, 5 pulleys;
- 80t hook, 3 pulleys;
- 35t hook, 1 pulley;
- 13.5t ball hook.



Safety Device

Assembly/Work Mode Control Switch

- Under the assembly mode, over-hoist limit switch, crane boom limit device and load moment limiter do not work, so as to facilitate the installation of crane;
- All safety limit devices work in the work mode.

Emergency Stop

- In emergent situation, this button is pressed down to cut off the power supply of whole machine and all actions stop.

Load Moment Limiter (LMI)

- It is an independent computerized safety control system. LMI can automatically detect the load weight, work radius and boom angle, and present on the display the rated load, actual load, work radius and boom angle. In normal operation, the LML can make a judgment and cut off automatically if the crane moves towards dangerous direction. It can also perform as a black box to record the lifting information;
- It is composed of monitor, angle sensor and force sensor and other parts.

Over-hoist Limit Switch of Main/Auxiliary Hooks

- Over-hoist protection device comprises of limit switch and weight on boom top, which prevents the hook lifting up too much;
- When the hook lifts up to the limit height, the limit switch activates, buzzer on the left control panel sends alarm, failure indicator light starts to flash, and the hook hoisting action is cut off automatically, cut off automatically.

Over-release Limit Switch of Main/Auxiliary Hooks

- It is comprised of activator in the drum and proximity switch to prevent over release of wire rope. When the rope is paid out close to the last three wraps, the limit switch acts, and the system sends alarm through buzzer and show the alarm on the instrument panel, automatically cutting off the winch action.

Function Lock Lever

- If the function lock level is not in work position, all the other handles won't work, which prevents any mis-operation caused by accidental collision.

Boom Hoist Drum Lock

- Pawl lock is used on boom hoist winch, which needs to unlock by switch before operation, in order to prevent mis-operation of handles and ensure safety during nonwork time.

Swing Lock Device

- Swing Lock can lock the machine at four positions, front and back, left and right.

Boom Limit Device

- When the boom elevation angle reaches the max. set limit, the buzzer sounds and boom action cut off. This protection is two-stage control ensured by both LML system and travel switch.

Back-stop Device

- Its major components are nesting tubes and spring, in order to buffer the boom backlash and prevent further tipping back.

Boom Angle Indicator

- Pendulum angle indicator is fixed on the side of boom base close to the cab, so as to provide convenience to the operator.

Hook Latch

- The hook is provided with a baffle to prevent wire rope from falling off.

Safety Device



Lightning Protection Device

- It is offered as an optional feature, which includes the grounding device that can effectively protect the electric system elements and workers from lightning.

Tri-color Load Indicator

- The load indication light has three colors, green, yellow and red, and the real time load status is presented on the display. When the actual load is smaller than 90% of rated load, the green light is on;
- When the actual load is larger than 90% and smaller than 100%, the yellow light is on, the alarm light flashes and sends out intermittent sirens;
- When the actual load reaches 100% of rated load, the red light is on, the alarm light flashes and sends out continuous sirens;
- When the actual load reaches 102% of rated load, the system will automatically cut off the crane operation in dangerous trend.

Audio-visual Alarm

- When the engine is working, the light flashes; when the machine is traveling or swinging, it sends out sirens.

Swing Indicator Light

- The swing indicator light flashes during traveling or swing.

Illuminating Light

- The machine is equipped with the low beam light and high beam light at the front of the cab, illumination light at cab, and other night lights, boom lights to improve the visibility during construction.

Rearview Mirror

- Separately set on the left front of the cab and on the handrail at the front of right sheet metal, so as to monitor the rear part of machine.

Pharos

- Pharos is mounted on the top of boom/jib to indicate the height.

Anemometer

- It is mounted on the top of boom/jib, and displayed on the monitor in the cab.

Electronic Level Indicator

- It displays the tipping angle of crane on the monitor in real time, protecting the machine from dangerous situation.

Seat Interlock

- Put down the function lock lever on the left side of cab seat or if the operator leaves the seat, all control levers will be deactivated to prevent any mis-operation due to accidental collision.



SCE1350A-EV
SANY PURE ELECTRIC CRAWLER CRANE
135 TONS LIFTING CAPACITY

QUALITY CHANGES THE WORLD

Technical Parameters

- Page 10 Major Performance Specifications
- Page 11 Outline Dimension
- Page 12 Transport Dimension
- Page 17 Transportation Plan



Major Performance Specifications

Major Performance & Specifications of SCE1350A-EV			
Performance Indicators		Unit	Parameter
Boom configuration	Maximum rated lifting capacity	t	135
	Maximum rated lifting moment	t·m	668 (95.4×7)
	Boom length	m	16~76
Fixed jib configuration	Maximum rated lifting capacity	t	27
	Jib length	m	13~31
	Longest main boom + jib	m	61+31
Luffing jib configuration	Maximum rated lifting capacity	t	40
	Jib length	m	22~52
	Longest main boom + jib	m	49+52
Operation speed	Rope speed of main/aux. load hoist (1st layer)	m/min	0~121
	Boom hoist winch rope speed (1st layer)	m/min	0~45
	Slewing speed	rpm	0~2.2
	Travelling speed	km/h	0~1.3
Motor	Reate power	kW	206
	Rated speed	rpm	1500
Transport parameter	Maximum transport weight of basic machine (including base)	t	41.2
	Maximum transport dimension of basic machine (L x W x H, mm)	mm	15954×3000×3294
Other parameters	Average ground bearing pressure	MPa	0.112
	Grade ability	%	30

Unit: mm

Outline Dimension

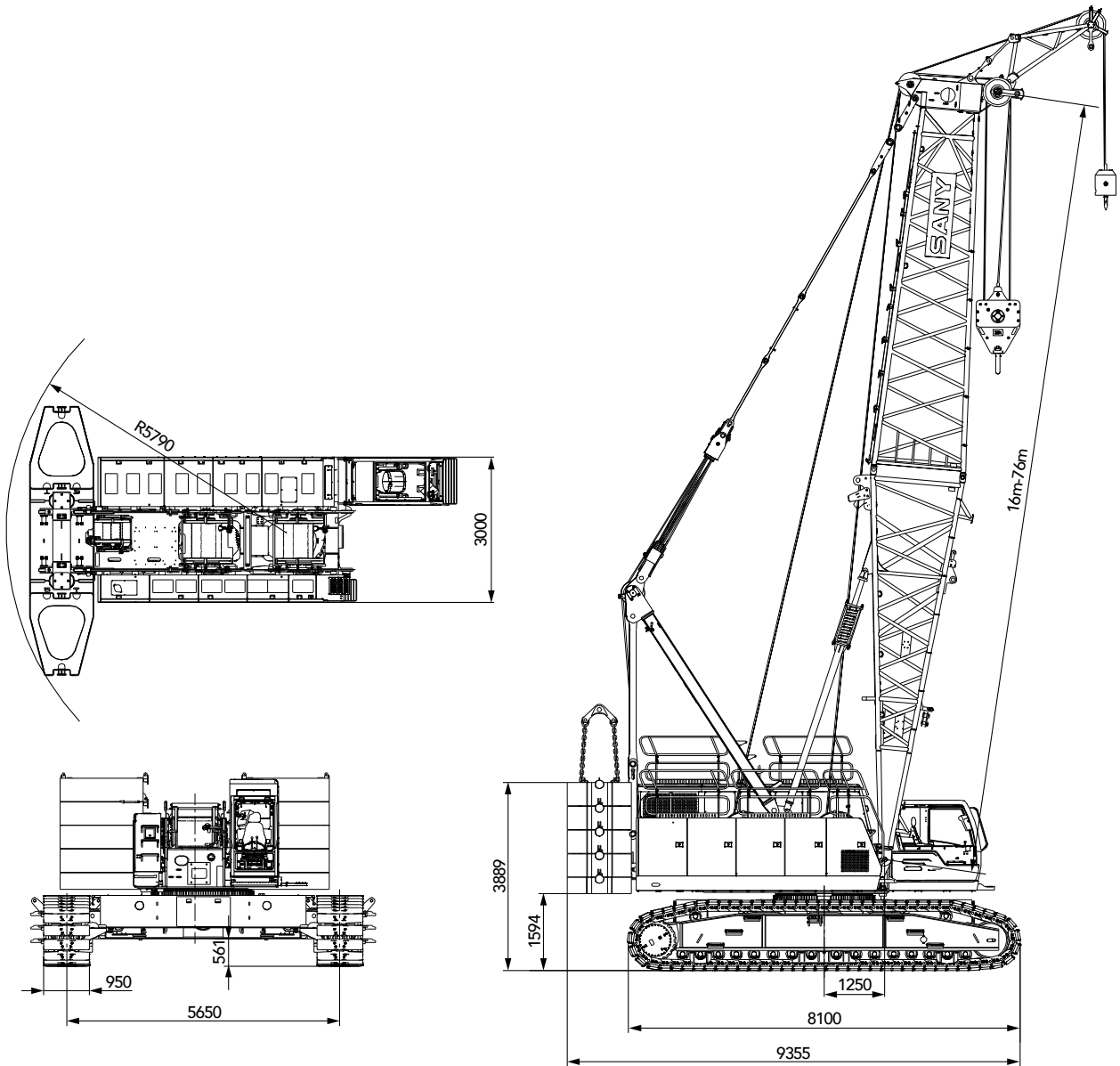

Transport Dimension

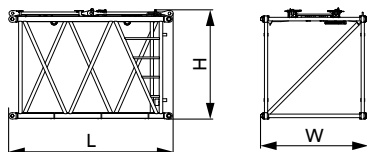
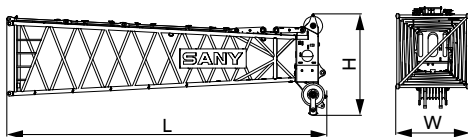
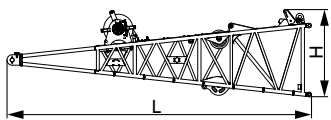
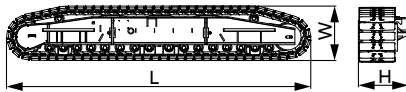
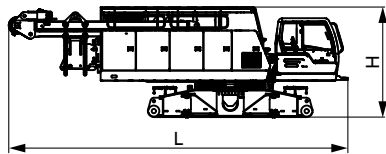
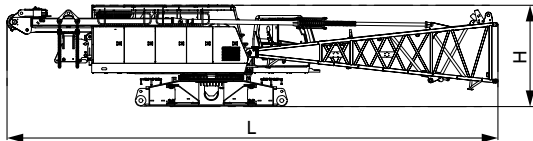

Basic machine including boom base and jib luffing winch ×1

Length (L)	15.95m
Width (W)	3.00m
Height (H)	3.29m
Weight	43.08t

Note: the weight of jib luffing winch and wire rope is 1.88t

Basic machine not including boom base ×1

Length (L)	10.12m
Width (W)	3.00m
Height (H)	3.29m
Weight	37.3t

Crawler assembly ×2

Length (L)	8.10m
Width (W)	1.46m
Height (H)	1.33m
Weight	17.78t

Boom base including jib luffing winch ×1

Length (L)	8.21m
Width (W)	2.08m
Height (H)	2.24m
Weight	5.78t

Note: the weight of jib luffing winch and wire rope is 1.88t

Boom top ×1

Length (L)	8.44m
Width (W)	1.96m
Height (H)	2.67m
Weight	2.79t

3m insert of main boom ×1

Length (L)	3.15m
Width (W)	2.06m
Height (H)	2.09m
Weight	0.64t

Transport Dimension

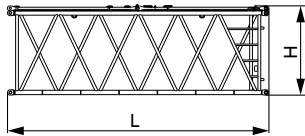

6m insert of main boom

×2

Length (L)	6.14m
Width (W)	2.06m
Height (H)	2.08m
Weight	1.06t

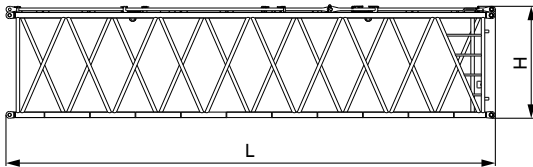

9m insert of main boom

×5

Length (L)	9.14m
Width (W)	2.06m
Height (H)	2.08m
Weight	1.50t

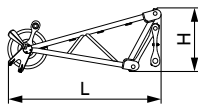

Extension boom

×1

Length (L)	2.36m
Width (W)	1.04m
Height (H)	0.98m
Weight	0.30t

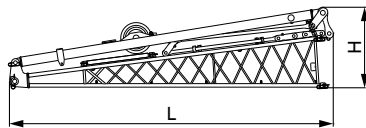

Fixed jib base (including strut)

×1

Length (L)	5.25m
Width (W)	1.19m
Height (H)	1.30m
Weight	0.91t

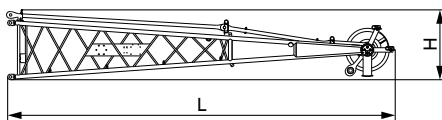

Fixed jib top

×1

Length (L)	5.43m
Width (W)	1.01m
Height (H)	0.99m
Weight	0.45t

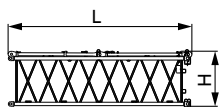

3m insert of fixed jib

×1

Length (L)	3.12m
Width (W)	1.02m
Height (H)	0.92m
Weight	0.19t

Transport Dimension

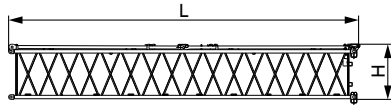

6m insert of fixed jib

×3

Length (L)	6.12m
Width (W)	1.02m
Height (H)	0.92m
Weight	0.34t

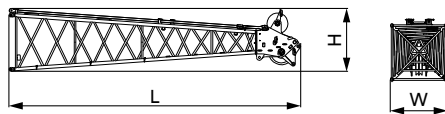

Luffing jib top (with jib extension)

×1

Length (L)	7.01m
Width (W)	1.38m
Height (H)	1.51m
Weight	0.89t

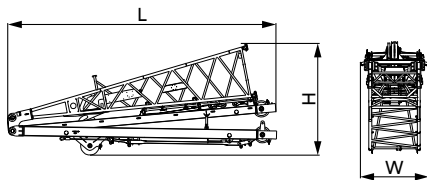

Luffing jib base (with struts)

×1

Length (L)	7.19m
Width (W)	1.83m
Height (H)	3.00m
Weight	3.20t

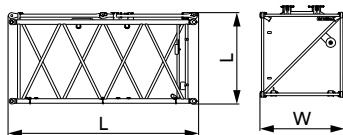

3m luffing jib insert

×2

Length (L)	3.14m
Width (W)	1.39m
Height (H)	1.50m
Weight	0.29t

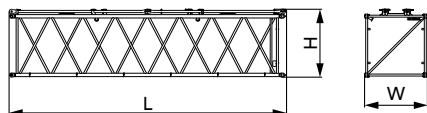

6m luffing jib insert

×1

Length (L)	6.14m
Width (W)	1.39m
Height (H)	1.50m
Weight	0.47t

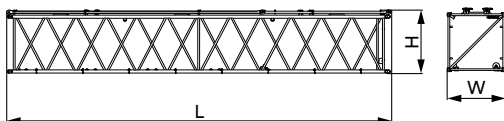

9m luffing jib insert

×3

Length (L)	9.14m
Width (W)	1.39m
Height (H)	1.50m
Weight	0.71t

Transport Dimension

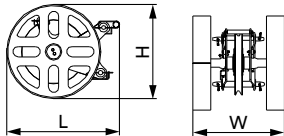

Luffing jib extension

×1

Length (L)	1.10m
Width (W)	0.89m
Height (H)	0.92m
Weight	0.29t

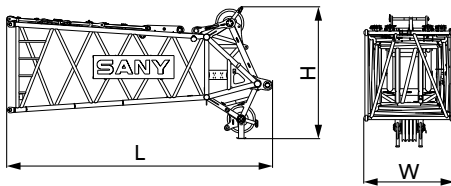

Boom top (for LJ only)

×1

Length (L)	5.75m
Width (W)	1.96m
Height (H)	2.85m
Weight	2.26t

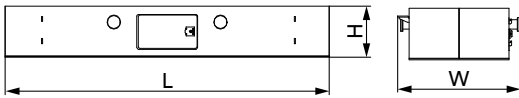

Carbody counterweight

×2

Length (L)	4.26m
Width (W)	1.57m
Height (H)	0.67m
Weight	10.00t

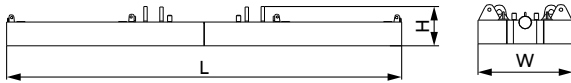

Rear counterweight tray

×1

Length (L)	5.56m
Width (W)	1.33m
Height (H)	0.55m
Weight	12.00t

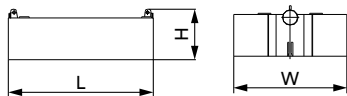

Counterweight block

×8

Length (L)	1.71m
Width (W)	1.33m
Height (H)	0.59m
Weight	5.00t

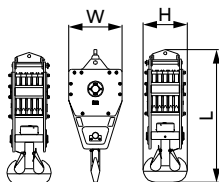

135t lifting hook

×1

Length (L)	2.26m
Width (W)	0.91m
Height (H)	0.75m
Weight	2.04t

Transport Dimension

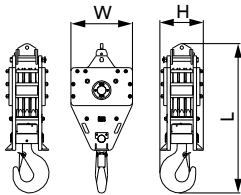

80t lifting hook

×1

Length (L)	2.21m
Width (W)	0.91m
Height (H)	0.64m
Weight	1.94t

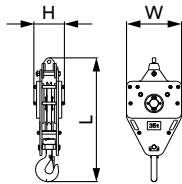

35t lifting hook

×1

Length (L)	1.88m
Width (W)	0.91m
Height (H)	0.46m
Weight	1.20t

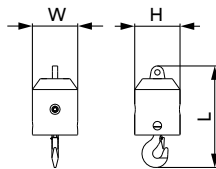

13.5t ball hook

×1

Length (L)	0.95m
Width (W)	0.43m
Height (H)	0.43m
Weight	0.45t

Remarks:

- 1.The transport dimensions for the parts are for reference that do not draw to the scale. The dimensions listed above are deisnged values excluding packing.
- 2.Weight is design values. It maybe different due to manufacturing tolerances.

Transport Plan

Transport with crawler frame

Transport cart 1	
Components included	<ul style="list-style-type: none"> Basic machine (3 winches, base assembly, A-frame, all wire ropes), boom/jib base
Transport weight	<ul style="list-style-type: none"> 41.2t

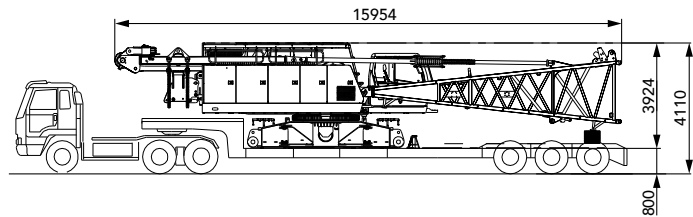

Transport cart 2	
Components included	<ul style="list-style-type: none"> Crawler frame: 17.78t 3m boom: 0.636t Packing case: 1t
Transport weight	<ul style="list-style-type: none"> 19.41t

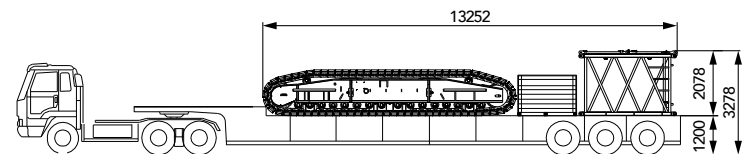

Transport cart 3	
Components included	<ul style="list-style-type: none"> Crawler frame: 17.78t Luffing jib top: 0.89t Luffing jib extension: 0.285t Boom extension: 0.29t
Transport weight	<ul style="list-style-type: none"> 19.24t

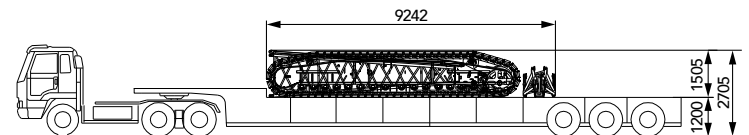

Transport cart 4	
Components included	<ul style="list-style-type: none"> Counterweight tray: 12t Boom top: 2.79t 6m boom: 0.34t Fixed jib base: 0.91t
Transport weight	<ul style="list-style-type: none"> 16.04t

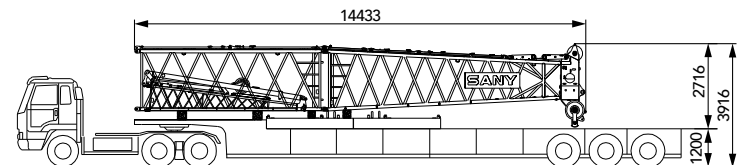

Transport cart 5	
Components included	<ul style="list-style-type: none"> Counterweight block * 3: 15t 9m boom: 1.5t 6m boom: 1.06t 3m luffing jib: 0.29t 6m luffing jib: 0.166t 6m fixed jib: 0.34t
Transport weight	<ul style="list-style-type: none"> 18.36t

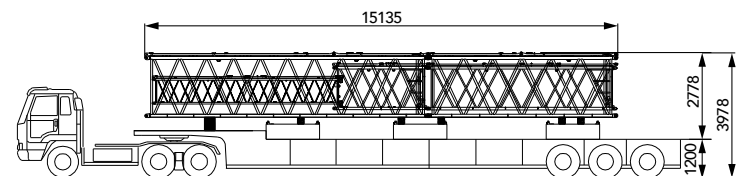

Transport Plan

Transport cart 6

- Components included**
- Counterweight block * 3: 15t
 - 9m luffing jib: 0.708t
 - 9m boom: 1.5t
 - Fixed jib top: 0.45t
 - 35t hook: 1.11t

Transport weight ▪ 18.77t

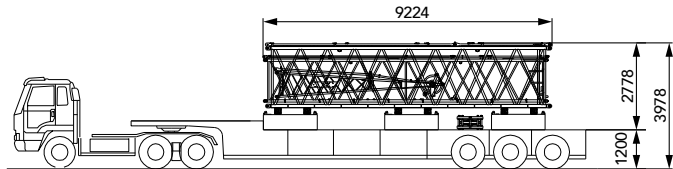

Transport cart 7

- Components included**
- Counterweight block * 2: 10t
 - 9m boom: 1.5t
 - 9m luffing jib: 0.708t
 - 6m fixed jib: 0.34t
 - 135t hook: 1.92t
 - 80t hook: 1.64t
 - 13.5t ball hook: 0.45t

Transport weight ▪ 16.56t

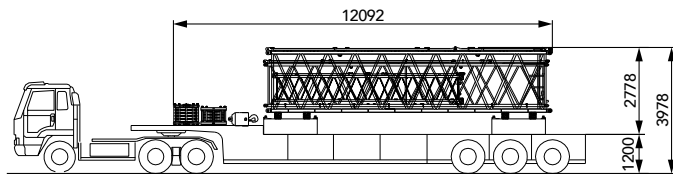

Transport cart 8

- Components included**
- Carbody counterweight: 10t
 - 9m boom: 1.5t
 - 3m luffing jib: 0.29t
 - 6m luffing jib: 1.57t

Transport weight ▪ 13.36t

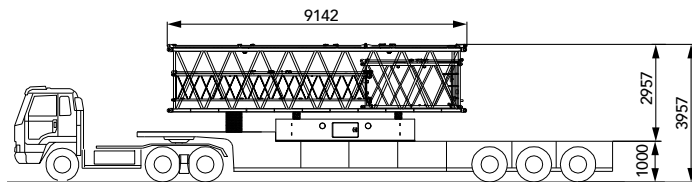

Transport cart 9

- Components included**
- Carbody counterweight: 10t
 - 9m boom: 1.5t
 - 3m fixed jib: 0.19t
 - 9m luffing jib: 0.708t

Transport weight ▪ 12.4t

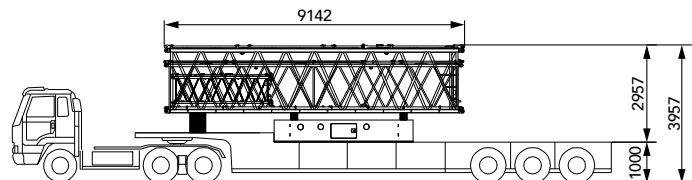

Transport cart 10

- Components included**
- Luffing jib base (with mast): 3.203t
 - Boom top (for LJ only) : 2.258t

Transport weight ▪ 5.461t

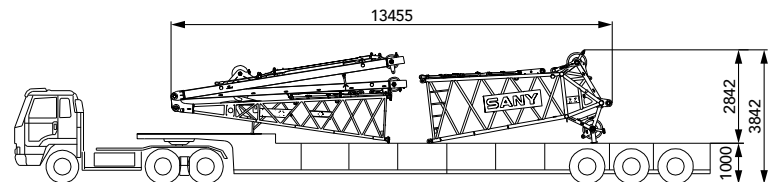



SCE1350A-EV
SANY PURE ELECTRIC CRAWLER CRANE
135 TONS LIFTING CAPACITY

QUALITY CHANGES THE WORLD

Configurations

- Page 20 Boom / Jib Combination
- Page 23 H Configuration
- Page 30 FJ Configuration
- Page 36 LJ Configuration
- Page 54 LJCZG Configuration

> 19

Boom / Jib Combination

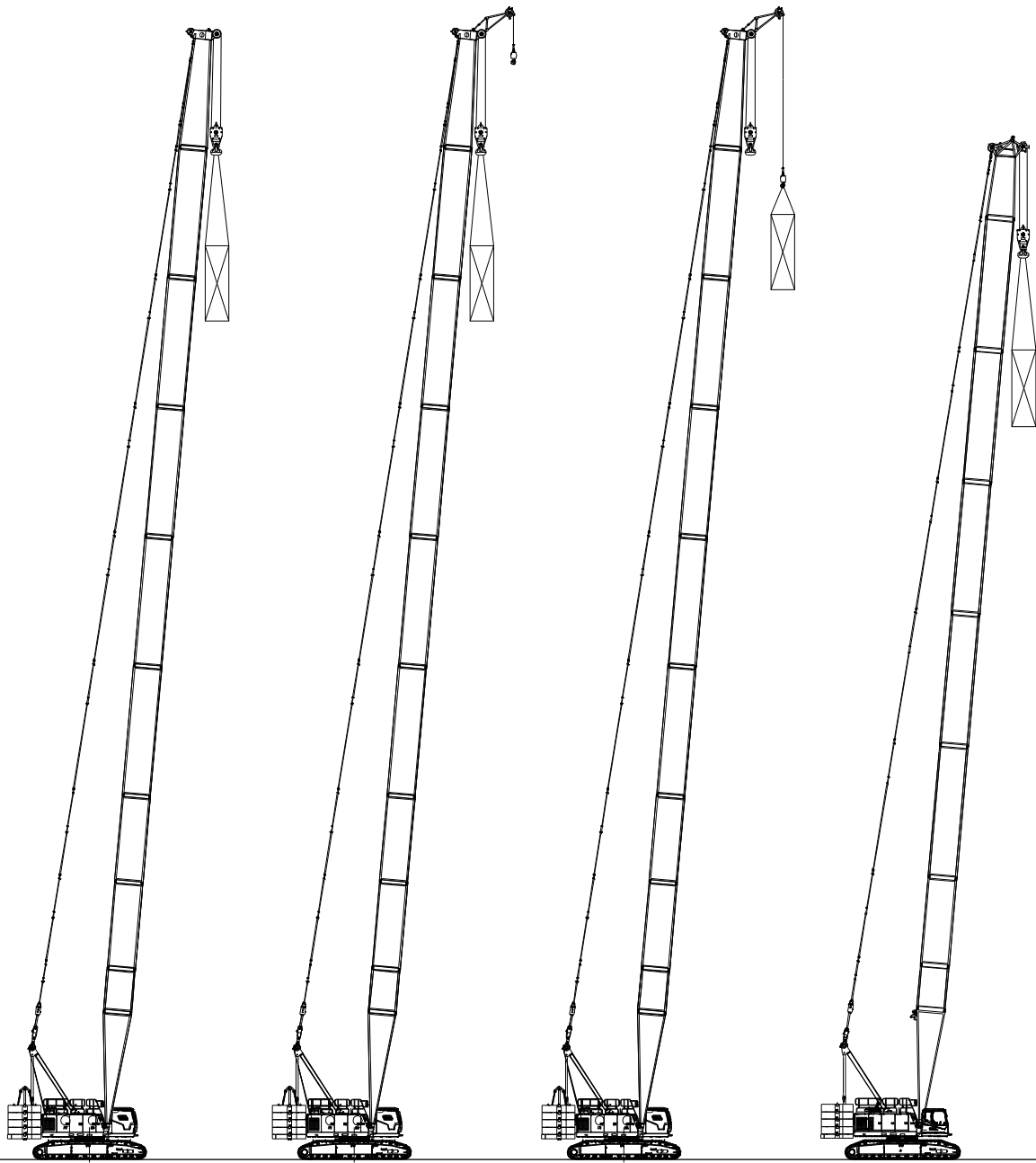

H Configuration

HCm Configuration
(double hooks,
load on main hook)

HCa Configuration
(double hooks,
load on aux. hook)

Hh Configuration

Configuration	Boom Combination	Boom Length
H	Boom	16m~76m
HCm	Boom + Extension jib (double hooks, load on main hook)	
HCa	Boom + Extension jib (double hooks, load on aux. hook)	
Hh	Boom (with boom top special for LJ)	22m~67m

Note: The schematics above are reference for loading only.

Boom / Jib Combination

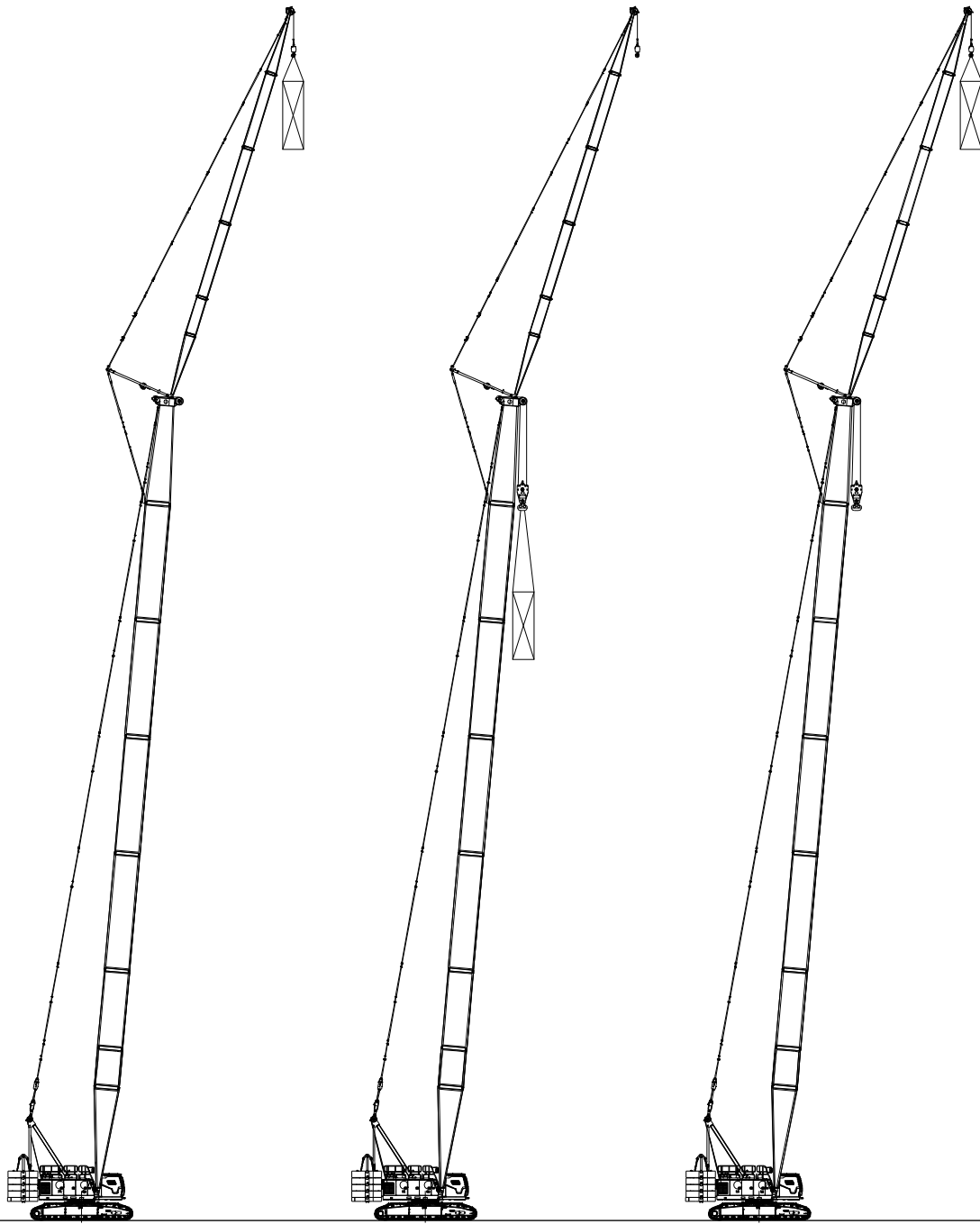

FJ Configuration
(single hook)

FJm Configuration
(double hooks, load on main hook)

FJa Configuration
(double hooks, load on aux. hook)

Configuration	Boom Combination	Boom Length
FJ	Boom + Fixed Jib (single hook)	(22m~61m)+(13m~31m)
FJm	Boom + Fixed Jib (double hooks, load on main hook)	
FJa	Boom + Fixed Jib (double hooks, load on aux. hook)	

Note: The schematics above are reference for loading only.

Boom / Jib Combination

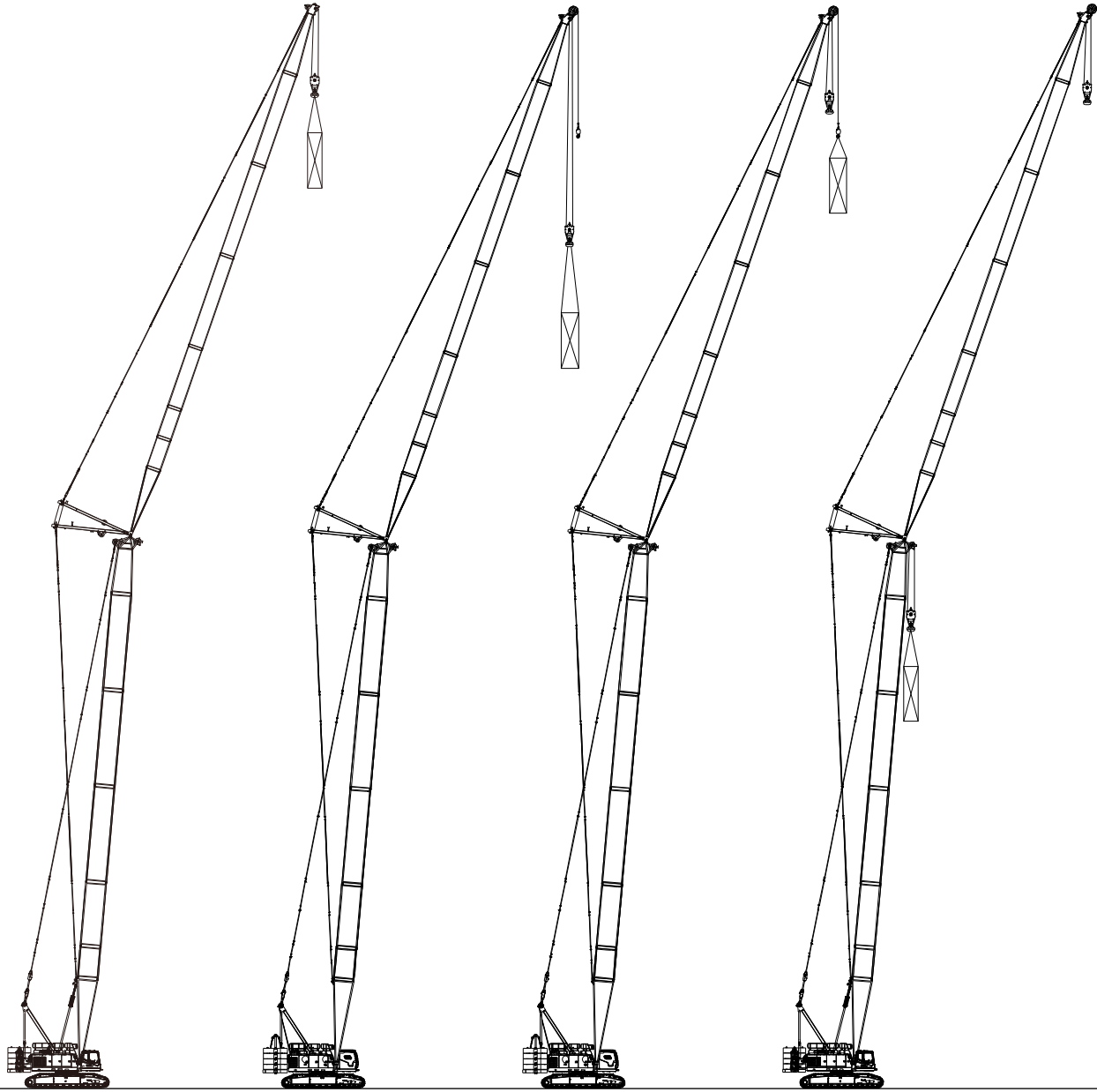

LJ Configuration
(single hook,
load on luffing jib hook)

LJm Configuration
(double hooks,
load on luffing jib hook)

LJa Configuration
(double hooks,
load on extension jib hook)

LJCZG Configuration
(double hooks,
load on main hook)

Configuration	Boom Combination	Boom Length
LJ	Boom + Luffing Jib (single hook, load on luffing jib hook)	(22m~49m)+(22m~52m)
LJm	Boom + Luffing Jib (double hooks, load on luffing jib hook)	
LJa	Boom + Luffing Jib (double hooks, load on extension jib hook)	
LJCZG	Boom + Luffing Jib (double hooks, load on main hook)	

Note: The schematics above are reference for loading only.

H Configuration

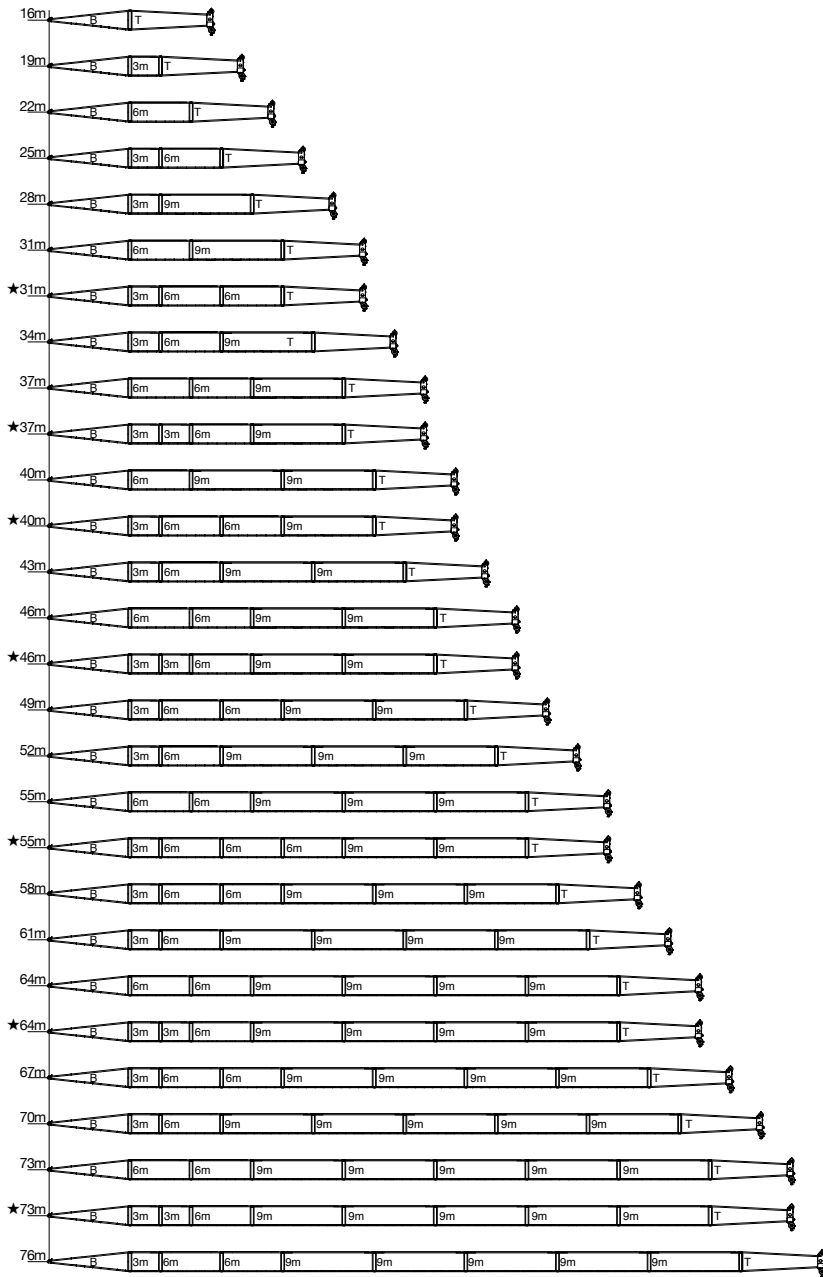

Note: The boom combinations with ★ are recommended for purchasing.

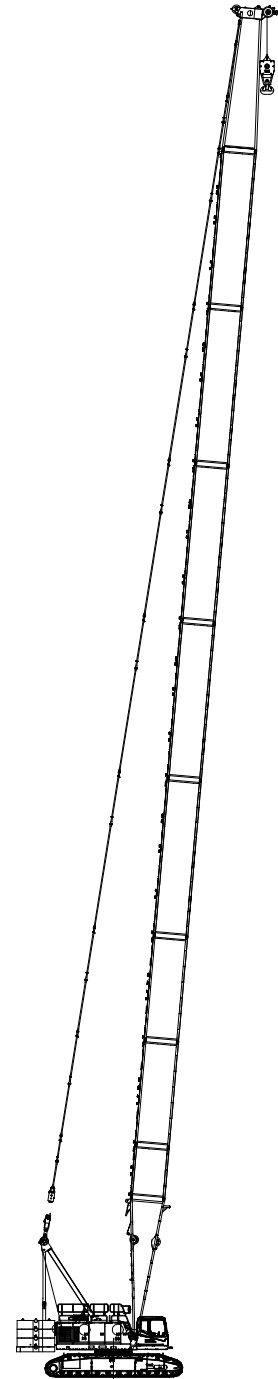
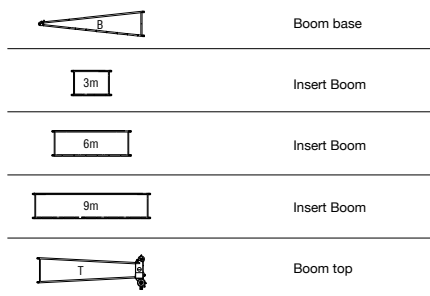

H Working Condition of main boom: 16m~76m

H Working Radius

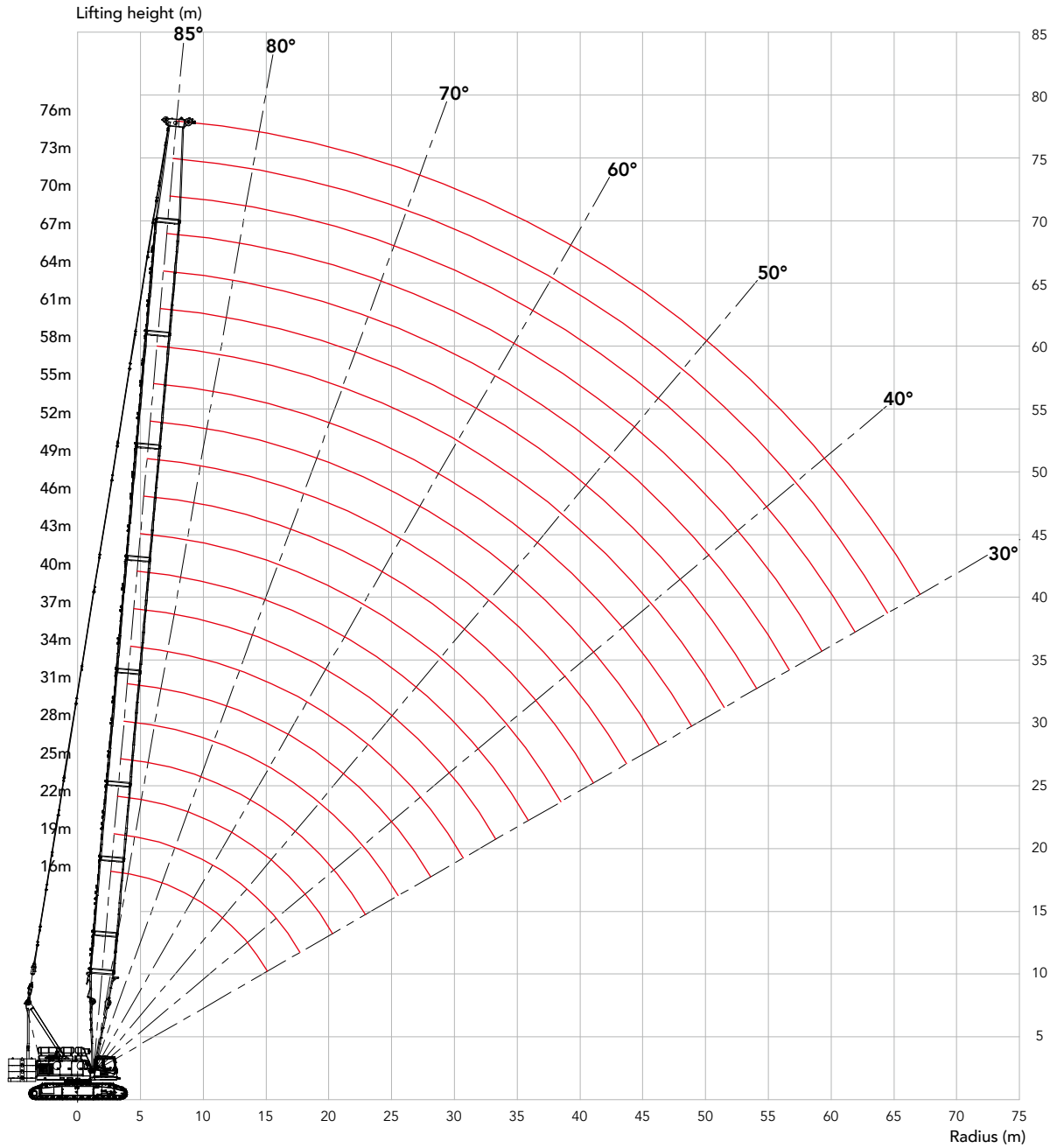

Unit: t

H Load Chart

Note:

- 1.The rated load in the load chart is calculated complying with EN 13000;
- 2.The working radius is the horizontal distance from the load center to the swing center;
- 3.The actual lifting capacity must subtract the weight of hooks and other riggings from the rated capacity in the load chart.
- 4.The load value is calculated when the object is hung freely,without considering the influence of wind on the load, ground conditions and slope, operation speed and the influence of any other negative factors over safe operation. Therefore, the operator bears the responsibility of making a judgement and decreasing the load and lowering speed.
- 5.All ratings are calculated when the machine is parking on firm and level ground with less than 1% gradient.
- 6.Parts of line as below are based on rated single line pull of 13.5t.

Load chart -H (Load on main hook, Boom 16~76m, Without extension jib) 1/6

Load on main hook, Boom 16m~76m, Without extension jib																
Boom length (m)	16					19					22					Boom length (m)
CW (t) \ R (m)	52+20	42+0	32+0	12+0	0+0	52+20	42+0	32+0	12+0	0+0	52+20	42+0	32+0	12+0	0+0	CW (t) \ R (m)
4.6	135															4.6
5	131					130										5
6	110	105	85	60	40	109.5					108.8					6
7	95.4	86.6	69.5	51.3	34.9	92.6	86	69	50.9	34.7	92	83.8	67.7	50.1	33.9	7
8	81	69.7	55.9	41.1	27.8	80.3	69.2	55.5	40.8	27.6	79.6	68.8	55.1	40.6	27.5	8
9	71.4	58.2	46.6	34.2	23	70.8	57.8	46.3	33.9	22.8	70.2	57.5	46	33.7	22.7	9
10	63.8	49.9	39.8	29.2	19.5	63.3	49.6	39.6	28.9	19.4	62.8	49.3	39.4	28.8	19.2	10
12	52	38.6	30.8	22.4	14.8	51.6	38.4	30.5	22.2	14.7	51.3	38.2	30.3	22	14.5	12
14	42.5	31.4	24.9	18	11.8	42.2	31.1	24.7	17.8	11.6	42	31	24.5	17.7	11.5	14
16						35.5	26.1	20.6	14.7	9.5	35.3	25.9	20.4	14.6	9.4	16
18						30.5	22.3	17.6	12.5	7.9	30.3	22.2	17.4	12.3	7.8	18
20											26.5	19.3	15.1	10.6	6.6	20

Load chart -H (Load on main hook, Boom 16~76m, Without extension jib) 2/6

Load on main hook, Boom 16m~76m, Without extension jib																
Boom length (m)	25					28					31					Boom length (m)
CW (t) \ R (m)	52+20	42+0	32+0	12+0	0+0	52+20	42+0	32+0	12+0	0+0	52+20	42+0	32+0	12+0	0+0	CW (t) \ R (m)
4.6																4.6
5																5
6	108															6
7	91.4	80.8	65.2	48.2	32.6	89.7					86.7					7
8	79.1	68.4	54.8	40.3	27.2	78.1	66.3	53.4	39.3	26.3	75.5	64.3	51.7	38	25.4	8
9	69.6	57.2	45.7	33.5	22.5	69.2	56.8	45.4	33.2	22.3	67	56	44.9	32.9	21.8	9
10	62.2	49	39.1	28.5	19.1	61.7	48.7	38.8	28.3	18.9	60.2	48.4	38.6	28.1	18.7	10
12	50.9	37.9	30.1	21.8	14.4	50.6	37.7	29.9	21.7	14.2	50.2	37.5	29.7	21.5	14.1	12
14	41.7	30.7	24.3	17.5	11.3	41.5	30.5	24.1	17.3	11.2	41.3	30.3	24	17.2	11.1	14
16	35	25.7	20.2	14.4	9.2	34.8	25.5	20.1	14.3	9.1	34.6	25.3	19.9	14.1	8.9	16
18	30.1	22	17.2	12.2	7.6	29.9	21.8	17.1	12	7.5	29.7	21.6	16.9	11.9	7.4	18
20	26.3	19.1	14.9	10.4	6.4	26.1	19	14.8	10.3	6.3	25.9	18.8	14.6	10.1	6.1	20
22	23.3	16.8	13.1	9	5.4	23.1	16.7	12.9	8.9	5.3	22.9	16.5	12.8	8.8	5.2	22
24						20.7	14.8	11.4	7.8	4.5	20.5	14.7	11.3	7.6	4.4	24
26							13.3	10.2			18.5	13.1	10	6.7	3.7	26
28											16.7	11.9	9		3.2	28

H Load Chart

Load chart -H (Load on main hook, Boom 16~76m, Without extension jib) 3/6

Load on main hook, Boom 16m~76m, Without extension jib																
Boom length (m)	34					37					40					Boom length (m)
CW (t) / R (m)	52+20	42+0	32+0	12+0	0+0	52+20	42+0	32+0	12+0	0+0	52+20	42+0	32+0	12+0	0+0	CW (t) / R (m)
7	84															7
8	73.2	62.4	50.1	36.8	24.5	71.3					63.4					8
9	64.9	54.4	43.6	31.9	21	63.2	53	42.4	30.9	20.3	61.3	51.6	41.3	30	19.6	9
10	58.4	48.1	38.3	27.9	18.3	56.9	47	37.5	27.2	17.7	55.2	45.8	36.5	26.4	17.1	10
12	48.7	37.2	29.5	21.3	13.9	47.5	37	29.3	21.1	13.8	46	36.7	29.1	20.9	13.4	12
14	41	30.1	23.7	17	10.9	40.6	29.9	23.6	16.8	10.7	39.4	29.7	23.4	16.6	10.6	14
16	34.4	25.1	19.7	13.9	8.8	34.4	24.9	19.5	13.8	8.6	34	24.7	19.4	13.6	8.5	16
18	29.5	21.4	16.7	11.7	7.2	29.5	21.3	16.5	11.5	7	29.1	21.1	16.4	11.4	6.9	18
20	25.7	18.6	14.4	10	6	25.7	18.4	14.2	9.8	5.8	25.3	18.2	14.1	9.6	5.7	20
22	22.7	16.3	12.6	8.6	5	22.7	16.1	12.4	8.4	4.8	22.4	16	12.2	8.3	4.7	22
24	20.3	14.5	11.1	7.4	4.2	20.3	14.3	10.9	7.3	4	19.9	14.1	10.8	7.1	3.9	24
26	18.2	12.9	9.8	6.5	3.5	18.2	12.8	9.7	6.4	3.4	17.9	12.6	9.5	6.2	3.2	26
28	16.5	11.7	8.8	5.7	3	16.5	11.5	8.6	5.6	2.8	16.2	11.3	8.5	5.4	2.6	28
30	15.1	10.5	7.9	5	2.5	15.1	10.4	7.7	4.9	2.4	14.7	10.2	7.6	4.7	2.1	30
32						13.8	9.4	7	4.3		13.5	9.3	6.8	4.2		32
34											12.4	8.4	6.1	3.7		34
36											11.4	7.7	5.5	3.2		36

Load chart -H (Load on main hook, Boom 16~76m, Without extension jib) 4/6

Load on main hook, Boom 16m~76m, Without extension jib														
Boom length (m)	43				46				49				Boom length (m)	
CW (t) / R (m)	52+20	42+0	32+0	12+0	52+20	42+0	32+0	12+0	52+20	42+0	32+0	12+0	CW (t) / R (m)	
9	54.7	50.2	40.1	29.1	53.3				52.1				9	
10	50.7	44.6	35.5	25.6	49.8	43.5	34.6	24.9	46.7	42.4	33.7	24.2	10	
12	44.7	36.3	28.7	20.5	43.6	35.5	28	19.9	41.5	34.6	27.3	19.3	12	
14	38.4	29.5	23.2	16.4	37.4	29.3	23	16.3	36.4	29	22.7	15.8	14	
16	33.2	24.5	19.2	13.4	32.5	24.3	19	13.3	31.7	24.1	18.8	13.1	16	
18	28.9	20.9	16.2	11.2	28.5	20.7	16	11	27.8	20.5	15.8	10.8	18	
20	25.1	18	13.9	9.5	24.9	17.9	13.7	9.3	24.7	17.6	13.5	9.1	20	
22	22.1	15.8	12	8.1	22	15.6	11.9	7.9	21.7	15.4	11.7	7.7	22	
24	19.7	13.9	10.6	7	19.5	13.8	10.4	6.8	19.3	13.6	10.2	6.6	24	
26	17.7	12.4	9.3	6	17.5	12.2	9.2	5.9	17.3	12	9	5.7	26	
28	16	11.1	8.3	5.2	15.8	11	8.1	5.1	15.6	10.8	7.9	4.8	28	
30	14.5	10	7.4	4.6	14.4	9.9	7.2	4.4	14.1	9.7	7	4.2	30	
32	13.3	9.1	6.6	4	13.1	8.9	6.4	3.8	12.9	8.7	6.2	3.5	32	
34	12.2	8.2	5.9	3.5	12	8.1	5.8	3.3	11.8	7.9	5.6	3	34	
36	11.2	7.5	5.3	3	11	7.3	5.2	2.8	10.8	7.1	5	2.6	36	
38	10.3	6.8	4.8	2.6	10.2	6.7	4.6	2.4	10	6.5	4.4	2.1	38	
40					9.4	6.1	4.2	2.1	9.2	5.9	4		40	
42									8.5	5.4	3.5		42	
44									7.9	4.9	3.1		44	

Unit: t

H Load Chart

Load chart -H(Load on main hook, Boom 16~76m, Without extension jib) 5/6

Load on main hook, Boom 16m~76m, Without extension jib										
Boom length (m)	52			55			58			Boom length (m)
CW (t) / R (m)	52+20	42+0	32+0	52+20	42+0	32+0	52+20	42+0	32+0	CW (t) / R (m)
10	45.6	41.4	32.8	44.7			40.1			10
12	41.5	33.8	26.6	40.6	33.1	26	36.1	32.3	25.3	12
14	35.5	28.4	22.1	34.7	27.7	21.6	33.8	27.1	21	14
16	31	23.9	18.6	30.2	23.7	18.3	29.5	23.1	17.8	16
18	27.2	20.3	15.6	26.6	20.1	15.4	25.9	19.9	15.2	18
20	24.1	17.5	13.3	23.6	17.3	13.2	23	17.1	13	20
22	21.6	15.2	11.5	21.1	15	11.3	20.5	14.8	11.1	22
24	19.1	13.4	10	18.9	13.2	9.9	18.5	13	9.7	24
26	17.1	11.9	8.8	16.9	11.7	8.6	16.7	11.5	8.4	26
28	15.4	10.6	7.7	15.2	10.4	7.6	15	10.2	7.4	28
30	14	9.5	6.9	13.8	9.3	6.7	13.6	9.1	6.4	30
32	12.7	8.5	6.1	12.5	8.4	5.9	12.3	8.2	5.6	32
34	11.6	7.7	5.4	11.4	7.5	5.2	11.2	7.3	5	34
36	10.7	7	4.8	10.5	6.8	4.6	10.3	6.6	4.3	36
38	9.8	6.3	4.3	9.6	6.1	4.1	9.4	5.9	3.8	38
40	9	5.7	3.8	8.8	5.6	3.6	8.6	5.4	3.3	40
42	8.3	5.2	3.4	8.2	5	3.2	8	4.8	2.9	42
44	7.7	4.7	3	7.5	4.6	2.8	7.3	4.4	2.5	44
46	7.1	4.3	2.6	7	4.1	2.5	6.8	3.9	2.1	46
48				6.4	3.7	2.1	6.2	3.5		48
50							5.8	3.2		50

H Load Chart

Load chart -H (Load on main hook, Boom 16~76m, Without extension jib) 6/6

Load on main hook, Boom 16m~76m, Without extension jib										
Boom length (m)	61		64		67		70	73	76	Boom length (m)
CW (t) R (m)	52+20	42+0	52+20	42+0	52+20	42+0	52+20	52+20	52+20	CW (t) R (m)
4.6										4.6
5										5
6										6
7										7
8										8
9										9
10										10
12	35.3	31.5	32.8		30.1		27.5	24	22.6	12
14	33.1	26.5	31.1	25.8	28.6	25.2	26.6	23.9	22.2	14
16	28.8	22.6	28.1	22.1	26.6	21.5	25.3	23.3	21.8	16
18	25.3	19.5	24.7	19	24.1	18.6	23.5	22.6	21.1	18
20	22.4	16.9	21.9	16.6	21.3	16.1	20.8	20.3	19.8	20
22	20	14.7	19.5	14.5	19	14.2	18.5	18.1	17.6	22
24	18	12.8	17.5	12.7	17.1	12.3	16.6	16.2	15.7	24
26	16.3	11.3	15.8	11.1	15.4	10.8	15	14.5	14.1	26
28	14.8	10	14.3	9.9	13.9	9.5	13.5	13.1	12.7	28
30	13.4	8.9	13	8.8	12.6	8.4	12.2	11.9	11.5	30
32	12.2	8	11.9	7.8	11.5	7.5	11.1	10.8	10.4	32
34	11.1	7.2	10.9	7	10.5	6.6	10.1	9.8	9.4	34
36	10.1	6.4	9.9	6.2	9.6	5.9	9.2	8.9	8.5	36
38	9.2	5.8	9.1	5.6	8.7	5.2	8.4	8.1	7.7	38
40	8.5	5.2	8.3	5	8	4.6	7.7	7.4	7	40
42	7.8	4.7	7.6	4.4	7.3	4.1	7	6.7	6.3	42
44	7.2	4.2	7	3.9	6.7	3.6	6.4	6.1	5.7	44
46	6.6	3.8	6.4	3.5	6.1	3.2	5.8	5.5	5.2	46
48	6.1	3.4	5.9	3.1	5.6	2.8	5.3	5	4.7	48
50	5.6	3	5.4	2.7	5.1	2.4	4.8	4.5	4.2	50
52	5.2		5		4.7		4.4	4.1	3.8	52
54	4.7		4.6		4.3		4	3.7	3.4	54
56			4.2		3.9		3.6	3.3	3	56
58					3.6		3.3	3	2.4	58
60							2.9	2.6		60
62							2.6			62

Unit: t

Hh Load Chart

Load chart - Hh																		
Load on main hook, Boom 22~67m																		
Boom length (m)	22	25	28	31	34	37	40	43	46	49	52	55	58	61	64	67	Boom length (m)	
CW (t)	52+20																CW (t)	
R (m)																	R (m)	
7	72	71.8	71.6														7	
8	71.3	70.9	70.5	70.2	69.9	69.6	63.4	61.7									8	
9	70.2	69.6	69.2	67	64.9	63.2	61.3	54.7	53.3	52.1	48.3	47.6	42.5				9	
10	62.8	62.2	61.7	60.2	58.4	56.9	55.2	50.7	49.8	46.7	45.6	44.7	40.1	38.2	34.2	30.9	10	
12	51.3	50.9	50.6	50.2	48.7	47.5	46	44.7	43.6	41.5	41.5	40.6	36.1	35.3	32.8	30.1	12	
14	42	41.7	41.5	41.3	41	40.6	39.4	38.4	37.4	36.4	35.5	34.3	33.1	31.5	30.6	28.6	14	
16	35.3	35	34.8	34.6	34.4	34.4	34	33.2	32.5	31.7	31	29.6	28.4	27.2	26.3	25.2	16	
18	30.3	30.1	29.9	29.7	29.5	29.5	29.1	28.9	28.5	27.8	27.2	25.7	24.9	23.9	22.9	22.1	18	
20	26.5	26.3	26.1	25.9	25.7	25.7	25.3	25.1	24.9	24.7	24.1	22.9	21.9	21	20.2	19.5	20	
22		23.3	23.1	22.9	22.7	22.7	22.4	22.1	22	21.7	21.6	20.4	19.6	18.7	18.1	17.3	22	
24			20.7	20.5	20.3	20.3	19.9	19.7	19.5	19.3	19.1	18.2	17.5	16.8	16.2	15.4	24	
26				18.5	18.2	18.2	17.9	17.7	17.5	17.3	17.1	16.5	15.8	15.2	14.5	13.9	26	
28				16.7	16.5	16.5	16.2	16	15.8	15.6	15.4	14.9	14.3	13.7	13	12.5	28	
30					15	15.1	14.7	14.5	14.4	14.1	14	13.6	13	12.4	11.9	11.3	30	
32						13.6	13.5	13.3	13.1	12.9	12.7	12.3	11.8	11.2	10.8	10.3	32	
34							12.2	12.2	12	11.8	11.6	11.1	10.7	10.3	9.8	9.3	34	
36							10.6	10.9	11	10.8	10.5	10.2	9.7	9.4	8.9	8.4	36	
38								9.6	9.7	9.8	9.4	9.1	8.9	8.5	8	7.6	38	
40									8.6	8.7	8.5	8.3	8	7.6	7.2	6.9	40	
42										7.8	7.5	7.5	7.3	7	6.5	6.3	42	
44										6.7	6.7	6.7	6.5	6.2	6	5.6	44	
46											5.9	5.9	5.8	5.5	5.3	5	46	
48												5.1	5	5	4.7	4.4	48	
50													4.4	4.3	4.2	3.8	50	
52														3.6	3.5	3.4	52	
54														3.1	3	2.9	54	
56															2.5	2.4	56	

FJ Configuration

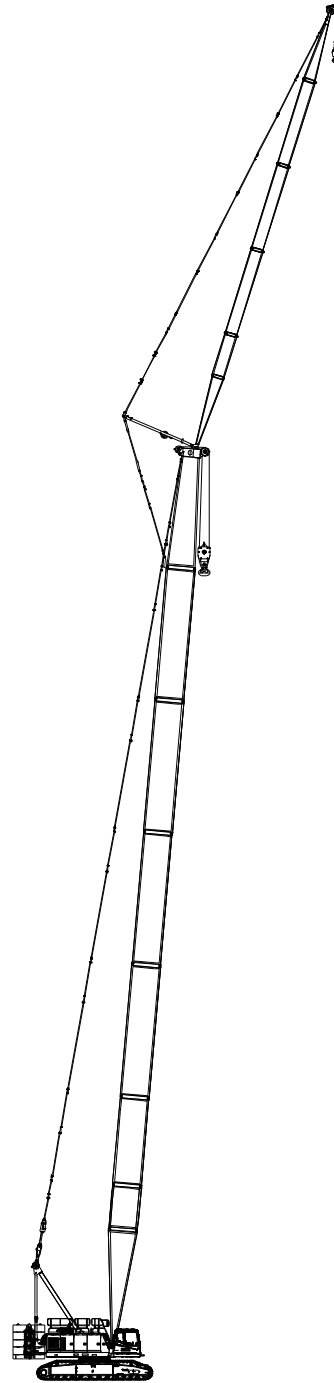
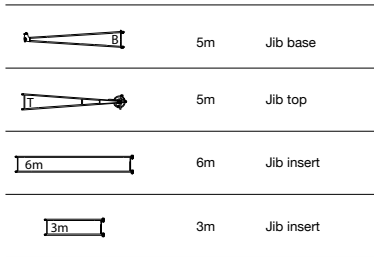
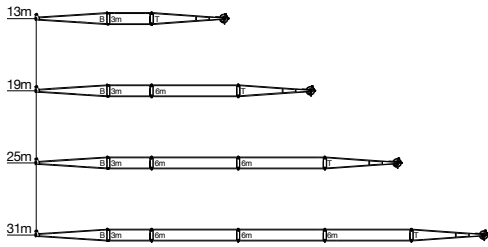

FJ Working Condition of fixed jib
(22m~61m)+(13m~31m)

FJ Working Radius

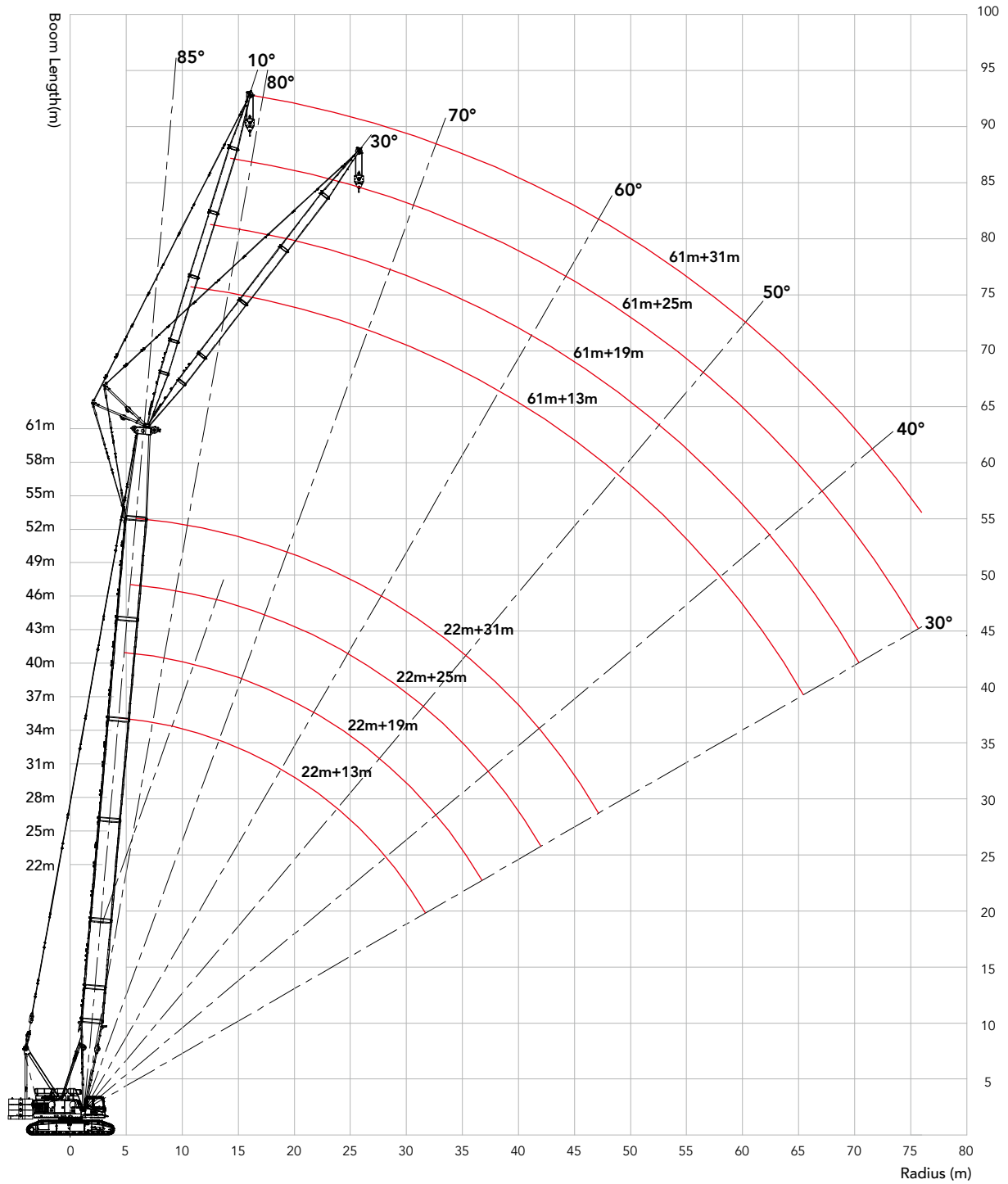

FJ Load Chart

- Note:
- 1.The rated load in the load chart is calculated complying with EN 13000;
 - 2.The working radius is the horizontal distance from the load center to the swing center;
 - 3.The actual lifting capacity must subtract the weight of hooks and other riggings from the rated capacity in the load chart.
 - 4.The load value is calculated when the object is hung freely,without considering the influence of wind on the load, ground conditions and slope, operation speed and the influence of any other negative factors over safe operation. Therefore, the operator bears the responsibility of making a judgement and decreasing the load and lowering speed.
 5. All ratings are calculated when the machine is parking on firm and level ground with less than 1% gradient.
 - 6.Parts of line as below are based on rated single line pull of 13.5t.
 7. When the jib length is 13m, 1 part of line is not permitted.

Load chart -FJ (Load on aux. hook, Boom 22~61m, Without main hook, 52t+20t full CW)

Jib 13m, Boom to jib angle 10°															
Jib length (m) R (m)	22	25	28	31	34	37	40	43	46	49	52	55	58	61	Jib length (m) R (m)
9	27	27													9
10	27	27	27	26.8	26.8										10
12	26.9	26.5	26.8	26.8	26.8	26.5	25.8	25.1							12
14	26.2	25.8	26.1	26.3	26.5	26.5	25.8	25.1	24.4	23.6	22.9	22			14
16	25.6	24.9	25.3	25.5	25.8	26	25.7	25.2	24.4	23.6	22.9	22	21.3	20.5	16
18	25.1	24.4	24.6	24.5	24.9	25.1	25.2	24.5	24.1	23.3	22.3	21.3	21	20.2	18
20	24.3	23.5	23.3	23.3	23.5	23.7	23.1	22.4	21.8	21.2	20.7	20.1	19.6	19.1	20
22	22.9	22.3	22.1	21.9	21.9	21.7	21	20.3	19.8	19.2	18.7	18.2	17.7	17.2	22
24	20.7	20.5	20.3	20.1	19.9	19.8	19.2	18.6	18.1	17.5	17	16.6	16.1	15.6	24
26	18.7	18.5	18.3	18.1	17.9	17.9	17.6	17.1	16.6	16.1	15.6	15.2	14.7	14.3	26
28	17	16.8	16.6	16.5	16.3	16.2	15.9	15.7	15.3	14.8	14.4	13.9	13.5	13.1	28
30	15.6	15.4	15.2	15	14.8	14.8	14.5	14.3	14.1	13.9	13.3	12.9	12.5	12.1	30
32	14.4	14.1	14	13.8	13.6	13.5	13.2	13.1	12.9	12.7	12.5	11.9	11.5	11.1	32
34		13.1	12.9	12.7	12.5	12.5	12.2	12	11.8	11.6	11.4	11.3	11	10.3	34
36			11.9	11.8	11.6	11.5	11.2	11	10.8	10.7	10.5	10.3	10.1	9.7	36
38			11.1	10.9	10.7	10.7	10.4	10.2	10	9.8	9.6	9.5	9.3	8.9	38
40				10.2	10	9.9	9.6	9.4	9.2	9.1	8.9	8.7	8.5	8.2	40
42					9.3	9.2	8.9	8.7	8.6	8.4	8.2	8	7.8	7.6	42
44						8.6	8.3	8.1	7.9	7.8	7.6	7.4	7.2	7	44
46							7.8	7.6	7.4	7.2	7	6.9	6.6	6.4	46
48							7.2	7	6.9	6.7	6.5	6.3	6.1	5.9	48
50								6.6	6.4	6.2	6	5.8	5.6	5.4	50
52									6	5.7	5.5	5.3	5.1	4.9	52
54										5.3	5.1	4.9	4.7	4.5	54
56										4.9	4.7	4.5	4.3	4.1	56
58											4.4	4.2	3.9	3.7	58
60												3.8	3.6	3.4	60
62													3.4	3.2	62
64													3	2.8	64
66														2.5	66
Parts of line	2	2	2	2	2	2	2	2	2	2	2	2	2	2	Parts of line

Unit: t

FJ Load Chart

Load chart -FJ (Load on aux. hook, Boom 22~61m, Without main hook, 52t+20t full CW)															
Jib 25m, Boom to jib angle 10°															
Jib length (m) R (m)	22	25	28	31	34	37	40	43	46	49	52	55	58	61	Jib length (m) R (m)
14	12.1	11.9													14
16	11.9	11.7	11.7	11.7	11.6										16
18	11.7	11.5	11.5	11.4	11.3	11.3	11.5	11.5							18
20	11.5	11.3	11.2	11	11	11.1	11.2	11.3	11.2	11.2	11.2	11.1			20
22	11.3	11	10.9	10.6	10.6	10.8	11	11	10.9	10.9	11	10.9	10.9	10.8	22
24	11.1	10.6	10.5	10.2	10.2	10.4	10.6	10.8	10.7	10.6	10.7	10.6	10.7	10.6	24
26	10.8	10.3	10.2	9.9	9.9	10	10.3	10.5	10.4	10.4	10.4	10.5	10.4	10.4	26
28	10.6	10	9.8	9.6	9.7	9.7	10	10.2	10.1	10.2	10.3	10.3	10.3	10.2	28
30	10.3	9.8	9.5	9.4	9.4	9.4	9.8	9.9	9.9	9.9	10	10.1	10	10	30
32	10.1	9.5	9.2	9	9.1	9.1	9.5	9.6	9.6	9.7	9.7	9.9	9.8	9.7	32
34	9.9	9.2	8.9	8.8	8.8	8.9	9.2	9.3	9.3	9.4	9.6	9.6	9.6	9.4	34
36	9.7	8.9	8.7	8.6	8.6	8.6	9	9	9.1	9.1	9.1	9.2	9.3	9	36
38	9.5	8.8	8.4	8.3	8.3	8.4	8.6	8.7	8.8	8.7	8.8	8.9	8.9	8.6	38
40	9.3	8.5	8.3	8.2	8	8.1	8.2	8.4	8.5	8.4	8.5	8.6	8.5	8.1	40
42	9.1	8.3	8	7.8	7.7	7.8	7.8	8.1	8.2	8.2	8.2	8.3	8	7.7	42
44	8.8	8	7.6	7.3	7.3	7.5	7.6	7.8	7.9	7.9	7.9	7.8	7.5	7.2	44
46		7.6	7.1	6.9	7	7.2	7.4	7.6	7.6	7.5	7.4	7.2	6.9	6.6	46
48			6.7	6.4	6.7	7	7.2	7.3	7.2	7	6.9	6.7	6.4	6.1	48
50				6.1	6.5	6.9	6.9	6.9	6.7	6.5	6.4	6.2	5.9	5.7	50
52					6.4	6.7	6.6	6.5	6.3	6.1	5.9	5.8	5.5	5.2	52
54					6.3	6.5	6.2	6	5.9	5.7	5.5	5.3	5.1	4.8	54
56						6.1	5.9	5.7	5.5	5.3	5.1	4.9	4.7	4.5	56
58							5.5	5.3	5.1	4.9	4.7	4.6	4.3	4.1	58
60								5	4.8	4.6	4.4	4.2	4	3.8	60
62								4.7	4.5	4.3	4.1	3.9	3.7	3.5	62
64									4.2	4	3.8	3.6	3.4	3.2	64
66											3.6	3.4	3.1	2.9	66
68											3.2	3	2.8	2.6	68
70											3	2.8	2.6	2.3	70
72												2.5	2.3	2.1	72
74													2.1		74
Parts of line	2	2	2	2	2	2	2	2	2	2	2	2	2	2	Parts of line

FJ Load Chart**Load chart -FJ (Load on aux. hook, Boom 22~61m, Without main hook, 52t+20t full CW)**

Jib 13m, Boom to jib angle 30°															
Jib length R (m)	22	25	28	31	34	37	40	43	46	49	52	55	58	61	Jib length R (m)
12	23.5	23.1													12
14	22.7	22.3	22.1	21.9	21.8										14
16	21.8	21.5	21.4	21.3	21.2	21.1	21	20.9							16
18	20.5	20.2	20.1	20.1	20	19.9	19.8	19.7	19.6	19.5	19.4	19.3			18
20	19.6	19.3	19.2	19.1	18.9	18.8	18.7	18.6	18.5	18.4	18.3	18.2	18.1	17.6	20
22	18.7	18.4	18.1	17.9	17.8	17.6	17.5	17.4	17.3	17.2	17.1	17	16.9	16.6	22
24	17.9	17.6	17.3	17.1	16.9	16.8	16.7	16.6	16.5	16.4	16.2	16.1	15.9	15.7	24
26	17.2	16.8	16.5	16.3	16.1	16	15.8	15.7	15.6	15.5	15.3	15.2	14.8	14.4	26
28	16.5	16.1	15.8	15.6	15.5	15.4	15.2	15.1	15	14.9	14.5	14	13.6	13.2	28
30	15.7	15.3	15	14.9	14.8	14.6	14.4	14.3	14.2	13.8	13.4	13	12.6	12.2	30
32	14.5	14	14.2	14	13.9	13.8	13.6	13.4	13.3	12.8	12.5	12.1	11.7	11.3	32
34		13.1	13	12.9	12.7	12.7	12.5	12.3	12.2	12	11.6	11.2	10.9	10.5	34
36		12.2	12.1	11.9	11.8	11.7	11.5	11.3	11.2	11	10.9	10.7	10.1	9.8	36
38			11.2	11	10.9	10.9	10.6	10.4	10.3	10.1	10	9.8	9.7	9.1	38
40				10.2	10.1	10.1	9.8	9.7	9.5	9.3	9.2	9.1	8.9	8.7	40
42					9.4	9.4	9.1	8.9	8.8	8.6	8.5	8.3	8.2	8	42
44					8.7	8.7	8.5	8.3	8.2	8	7.8	7.7	7.5	7.4	44
46						8.1	7.9	7.7	7.6	7.4	7.3	7.1	6.9	6.8	46
48							7.3	7.2	7	6.9	6.7	6.6	6.4	6.2	48
50								6.7	6.5	6.4	6.2	6	5.9	5.7	50
52									6.1	5.9	5.7	5.6	5.4	5.2	52
54									5.6	5.4	5.3	5.1	4.9	4.7	54
56										5	4.8	4.7	4.5	4.3	56
58											4.4	4.3	4.1	3.9	58
60												3.9	3.7	3.6	60
62												3.6	3.4	3.2	62
64													3	2.9	64
66														2.6	66
Parts of line	1	1	1	1	1	1	1	1	1	1	1	1	1	1	Parts of line

Unit: t

FJ Load Chart

Load chart -FJ (Load on aux. hook, Boom 22~61m, Without main hook, 52t+20t full CW)															
Jib 25m, Boom to jib angle 30°															
Jib length R (m)	22	25	28	31	34	37	40	43	46	49	52	55	58	61	Jib length R (m)
20	9.8	9.8													20
22	9.5	9.5	9.5	9.4	9.4										22
24	9.2	9.2	9.3	9.1	9.2	9.2	9.2	9.1							24
26	8.9	8.9	9	8.8	9	9	9	8.8	8.7	8.6	8.5	8.4			26
28	8.6	8.6	8.7	8.6	8.8	8.7	8.6	8.5	8.4	8.3	8.2	8.1	8	7.8	28
30	8.3	8.3	8.4	8.4	8.5	8.4	8.3	8.2	8.2	8.1	8	7.9	7.8	7.7	30
32	8	8	8.1	8.2	8.2	8.2	8	8	7.9	7.8	7.7	7.6	7.6	7.4	32
34	7.7	7.7	7.8	8	8	7.9	7.8	7.7	7.7	7.6	7.5	7.4	7.4	7.2	34
36	7.4	7.5	7.6	7.7	7.7	7.6	7.5	7.5	7.4	7.4	7.3	7.2	7.2	7	36
38	7.2	7.2	7.3	7.5	7.4	7.4	7.3	7.3	7.2	7.2	7.1	7	6.9	6.8	38
40	7	7	7.1	7.3	7.2	7.1	7.2	7.1	7	7	6.9	6.9	6.8	6.6	40
42	6.8	6.8	6.9	7.1	7	6.9	6.9	7	6.9	6.9	6.8	6.8	6.7	6.4	42
44	6.6	6.6	6.7	6.8	6.7	6.7	6.7	6.8	6.8	6.8	6.7	6.7	6.6	6.2	44
46		6.4	6.4	6.4	6.4	6.5	6.5	6.6	6.7	6.7	6.6	6.6	6.5	6.1	46
48		6.2	6.1	6	6.1	6.3	6.4	6.5	6.6	6.6	6.5	6.5	6.4	6	48
50			5.9	5.6	5.8	6.1	6.3	6.4	6.5	6.5	6.4	6.3	6.2	5.9	50
52				5.3	5.5	5.9	6.2	6.2	6.3	6.3	6.2	6.1	6	5.7	52
54					5.2	5.7	6.1	6	6.1	6	5.9	5.8	5.6	5.4	54
56					5	5.5	5.9	5.8	5.8	5.6	5.5	5.4	5.2	5	56
58						5.3	5.6	5.5	5.4	5.2	5.1	4.9	4.8	4.6	58
60							5.3	5.2	5	4.9	4.7	4.5	4.4	4.2	60
62									4.6	4.6	4.4	4.2	4.1	3.8	62
64									4.2	4.2	4	3.8	3.7	3.5	64
66									4	3.8	3.6	3.4	3.3	3.1	66
68										3.4	3.4	3.1	3	2.9	68
70												2.9	2.8	2.7	70
72												2.6	2.5	2.4	72
74												2.3			74
Parts of line	1	1	1	1	1	1	1	1	1	1	1	1	1	1	Parts of line

LJ Configuration

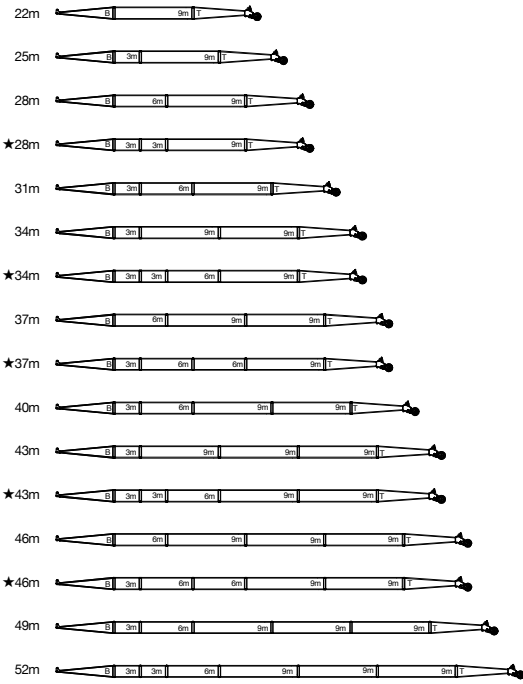

Note: The boom combinations with " ★ " are recommended for purchasing.

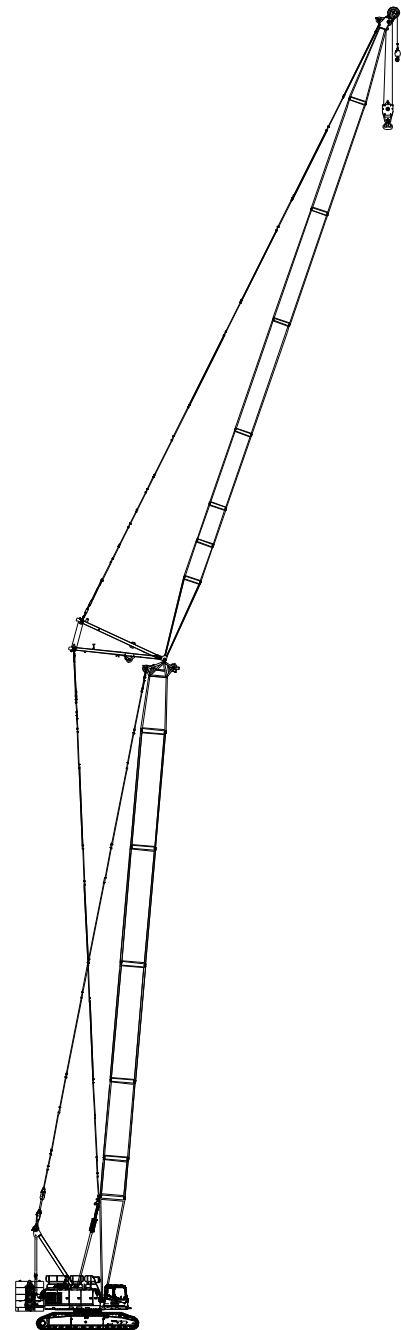
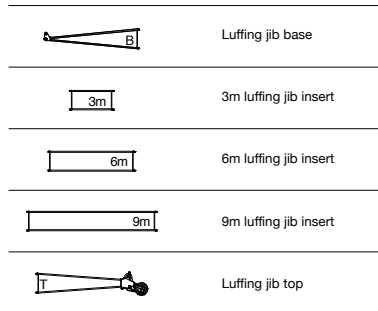

LJ configuration:
49m+52m

LJ Working Radius

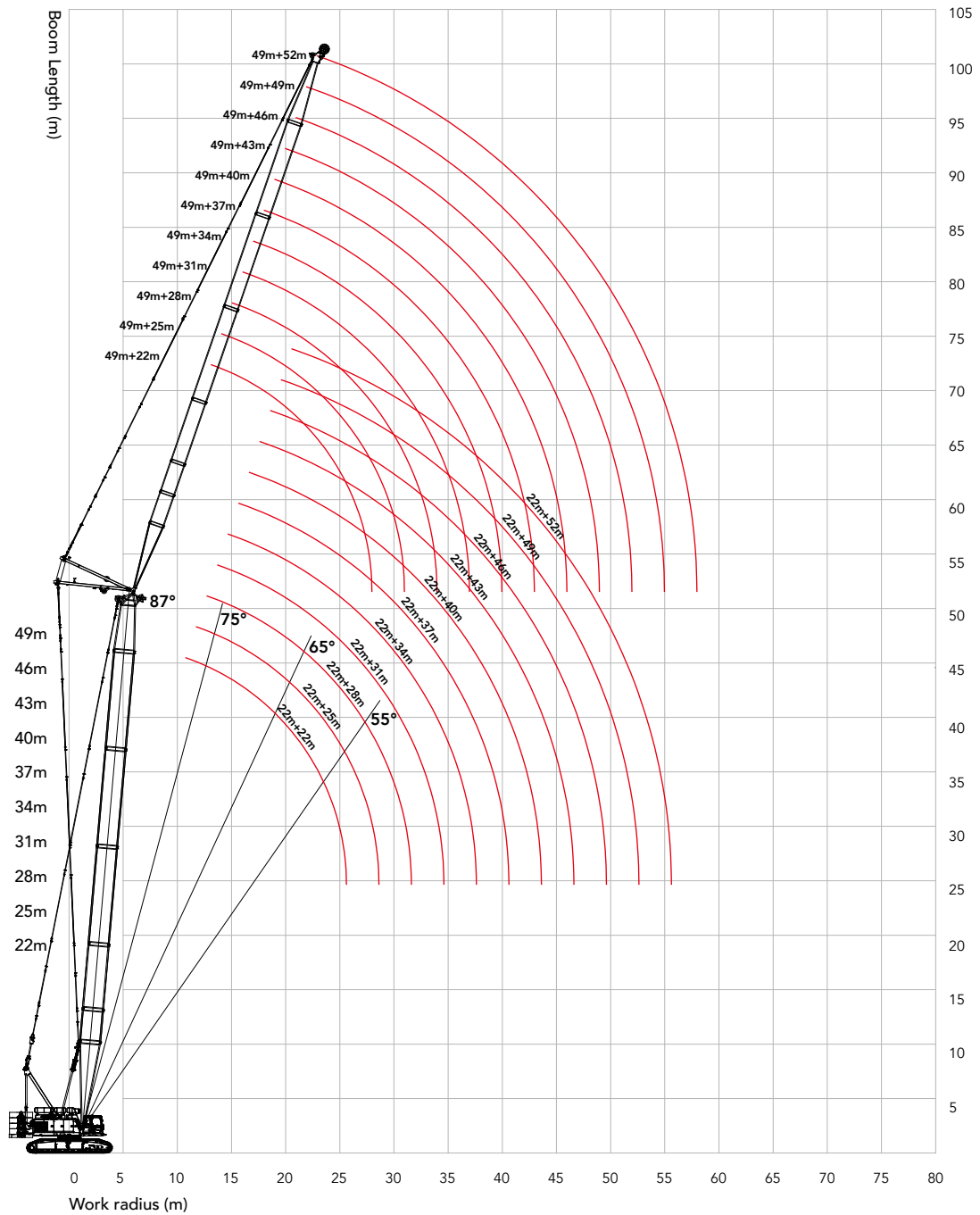

LJ Load Chart

Note:

- 1.The rated load in the load chart is calculated complying with EN 13000.
- 2.The working radius is the horizontal distance from the load center to the swing center.
- 3.The actual lifting capacity must subtract the weight of hooks and other riggings from the rated capacity in the load chart.
- 4.The load value is calculated when the object is hung freely,without considering the influence of wind on the load, ground conditions and slope, operation speed and the influence of any other negative factors over safe operation. Therefore, the operator bears the responsibility of making a judgment and decreasing the load and lowering speed.
- 5.All ratings are calculated when the machine is parking on firm and level ground with less than 1% gradient.
6. Parts of line as below are based on rated single line pull of 13.5t.

Load chart -LJ (Load on luffing jib hook, Without extension jib, 52t+20t full CW)

Boom 22m, Boom angle 55°												
BL (m) R (m)	22	25	28	31	34	37	40	43	46	49	52	BL (m) R (m)
32	14.5											32
34	13.5	13.3										34
36		12.4	12.2									36
38		11.5	11.4	11.2								38
40			10.7	10.5	10.4							40
42				9.9	9.7							42
44				9.2	9.1	9						44
46					8.6	8.5	8.3					46
48						8	7.8	7.7				48
50						7.5	7.4	7.2	6.2			50
52							7	6.8	6.2	5		52
54								6.4	5.8	4.9	3.9	54
56								5.8	5.4	4.7	3.8	56
58									5.4	4.3	3.6	58
60										3.9	3.3	60
62											2.9	62
64											2.6	64
Parts of line	3	3	3	2	2	2	2	1	1	1	1	Parts of line

Load chart -LJ (Load on luffing jib hook, Without extension jib, 52t+20t full CW)

Boom 31m, Boom angle 55°												
BL (m) R (m)	22	25	28	31	34	37	40	43	46	49	52	BL (m) R (m)
38	10.5											38
40	9.8	9.6										40
42		9	8.9									42
44			8.4	8.2								44
46			7.8	7.7	7.5							46
48				7.2	7.1	7						48
50					6.7	6.6	6.4					50
52					6.3	6.2	6	5.9				52
54						5.8	5.7	5.5				54
56							5.3	5.2	5.1			56
58							5	4.9	4.8	4.6		58
60								4.6	4.5	4.3	3.7	60
62									4.3	4.1	3.6	62
64									4	3.9	3.6	64
66										3.6	3.2	66
68											2.9	68
Parts of line	3	3	3	2	2	2	2	1	1	1	1	Parts of line

Unit: t

LJ Load Chart

Load chart -LJ (Load on luffing jib hook, Without extension jib, 52t+20t full CW)

Boom 40m, Boom angle 55°												
BL (m) R (m)	22	25	28	31	34	37	40	43	46	49	52	BL (m) R (m)
42	7.5											42
44	7.4	7.2										44
46	7	6.8	6.4									46
48		6.4	6.3									48
50			5.9	5.7								50
52				5.4	5.2							52
54				5.1	4.9	4.8						54
56					4.6	4.5	4.3					56
58						4.3	4.1	3.9				58
60						4	3.8	3.7	3.6			60
62							3.6	3.5	3.3	3.1		62
64								3.3	3.1	2.9	2.7	64
66								3.1	2.9	2.8	2.6	66
68									2.8	2.6	2.4	68
70										2.4	2.2	70
72										2.2	2.1	72
74											1.9	74
Parts of line	3	3	3	2	2	2	2	1	1	1	1	Parts of line

Load chart -LJ (Load on luffing jib hook, Without extension jib, 52t+20t full CW)

Boom 49m, Boom angle 55°												
BL (m) R (m)	22	25	28	31	34	37	40	43	46	49	52	BL (m) R (m)
48	4.9											48
50	4.9	4.5										50
52		4.2	4.2									52
54		4.2	3.9	3.4								54
56			3.6	3.4	3.3							56
58				3.2	3	2.8						58
60				3	2.9	2.8	2.5					60
62					2.9	2.5	2.3					62
64						2.4	2.2	2.1				64
66							2	1.9	1.7			66
68							1.9	1.8	1.6	1.4		68
70								1.8	1.5	1.2	1.1	70
72									1.4	1.2	1	72
74									1.4	1		74
Parts of line	3	3	3	2	2	2	2	1	1	1	1	Parts of line

LJ Load Chart**Load chart -LJ (Load on luffing jib hook, Without extension jib, 52t+20t full CW)**

Boom 22m, Boom angle 65°												
BL (m) R (m)	22	25	28	31	34	37	40	43	46	49	52	BL (m) R (m)
24	22.4											24
26	20.3	20.2										26
28	18.6	18.4	18.3									28
30	17.1	16.9	16.8	16.7								30
32	15.8	15.7	15.6	15.4	15.3							32
34		14.5	14.4	14.3	14.2	13.1						34
36			13.5	13.3	13.2	13	10.7	8.9				36
38			12.6	12.4	12.3	12.2	10.6	8.8	7.3			38
40				11.7	11.6	11.5	10.6	8.7	7.1	5.9		40
42					10.9	10.8	9.9	8.5	7	5.8	4.8	42
44					9.8	10	9.1	8.2	6.9	5.7	4.6	44
46						9.2	8.4	7.6	6.8	5.5	4.5	46
48							7.7	7	6.4	5.4	4.4	48
50								6.4	5.8	5.1		50
52								5.9	5.3			52
Parts of line	3	3	3	2	2	2	2	1	1	1	1	Parts of line

Load chart -LJ (Load on luffing jib hook, Without extension jib, 52t+20t full CW)

Boom 31m, Boom angle 65°												
BL (m) R (m)	22	25	28	31	34	37	40	43	46	49	52	BL (m) R (m)
28	15.7											28
30	14.4	14.3										30
32	13.4	13.3	13.1									32
34	12.4	12.2	12.1	11.9								34
36	11.5	11.4	11.3	11.1	10.9							36
38		10.7	10.5	10.4	10.2	10.2						38
40			9.8	9.8	9.6	9.4	9.3	8.4				40
42			9.2	9.1	9	8.9	8.7	8.3	6.9			42
44				8.6	8.5	8.4	8.1	8	6.8	5.6		44
46					7.9	7.9	7.7	7.5	6.7	5.5	4.5	46
48						7.4	7.2	7.1	6.6	5.4	4.4	48
50						7	6.8	6.7	6.5	5.3	4.3	50
52							6.4	6.3	6.2	5.2	4.2	52
54								5.9	5.8	5.1	4.1	54
56								5.6	5.4	4.8	4	56
58									5	4.4	3.7	58
60										4		60
Parts of line	3	3	3	2	2	2	2	1	1	1	1	Parts of line

Unit: t

LJ Load Chart

Load chart -LJ (Load on luffing jib hook, Without extension jib, 52t+20t full CW)

Boom 40m, Boom angle 65°												
BL (m) R (m)	22	25	28	31	34	37	40	43	46	49	52	BL (m) R (m)
32	11.4											32
34	10.5	10.4										34
36	9.7	9.7	9.5									36
38	9.1	8.9	8.9	8.6								38
40	8.5	8.4	8.2	8	7.9							40
42		7.8	7.7	7.6	7.4	7.2	7					42
44			7.2	7.1	6.9	6.8	6.6	6.4				44
46				6.7	6.5	6.3	6.2	6	5.9			46
48				6.3	6.1	6	5.8	5.6	5.5	5.3		48
50					5.8	5.7	5.4	5.3	5.1	5	4.3	50
52						5.3	5.1	5	4.8	4.6	4.2	52
54						4.9	4.8	4.6	4.5	4.3	4.1	54
56							4.6	4.4	4.2	4.1	3.9	56
58								4.2	4	3.9		58
60								3.9	3.8			60
Parts of line	3	3	3	2	2	2	2	1	1	1	1	Parts of line

Load chart -LJ (Load on luffing jib hook, Without extension jib, 52t+20t full CW)

Boom 49m, Boom angle 65°										
BL (m) R (m)	22	25	28	31	34	37	40	43	46	BL (m) R (m)
36	8									36
38	7.6	7.4								38
40	7	6.8	6.7							40
42	6.6	6.4	6.3	6						42
44		6	5.9	5.6	5.5	5.3				44
46		5.6	5.5	5.4	5.1	4.9	4.7			46
48			5.2	5	4.9	4.6	4.4	4.2		48
50				4.7	4.5	4.3	4.1	3.9	3.8	50
52				4.5	4.3	4.1	3.8	3.7	3.5	52
54					3.9	3.7	3.6	3.4	3.3	54
56						3.5	3.4	3.2		56
58						3.3	3.2			58
Parts of line	3	3	3	2	2	2	2	1	1	Parts of line

LJ Load Chart**Load chart -LJ (Load on luffing jib hook, Without extension jib, 52t+20t full CW)**

Boom 22m, Boom angle 75°												
BL (m) R (m)	22	25	28	31	34	37	40	43	46	49	52	BL (m) R (m)
18	30.9											18
20	27.3	27.3	26									20
22	24.5	24.4	24.3	21.9								22
24	22.2	22	22.1	20.8	18.6	15.4						24
26	20.1	20	20.1	19.4	17.9	15.2	12.7	10.7				26
28	16.9	18.2	18.3	18.1	16.6	14.9	12.4	10.4	8.8			28
30		15.7	16.5	16.5	15.5	14.3	12.2	10.2	8.5	7.2	6	30
32			14.5	14.7	14.3	13.3	11.9	9.9	8.3	7	5.8	32
34			12.2	13.1	13.3	12.3	11.3	9.7	8.1	6.7	5.6	34
36				11.5	12.1	11.4	10.4	9.4	7.9	6.5	5.4	36
38					10.8	10.4	9.6	8.7	7.7	6.4	5.2	38
40					9.1	9.5	8.8	8.1	7.3	6.2	5.1	40
42						8.7	8.1	7.4	6.7	6	4.9	42
44							7.4	6.8	6.2	5.5	4.7	44
46							6.7	6.2	5.7	5	4.3	46
48								5.6	5.1	4.5	3.9	48
50									4.7	4.1	3.5	50
52										3.6	3.1	52
54										3.3	2.8	54
56											2.4	56
Parts of line	3	3	3	2	2	2	2	1	1	1	1	Parts of line

Unit: t

LJ Load Chart

Load chart -LJ (Load on luffing jib hook, Without extension jib, 52t+20t full CW)												
Boom 31m, Boom angle 75°												
BL (m) R (m)	22	25	28	31	34	37	40	43	46	49	52	BL (m) R (m)
20	23.2											20
22	20.8	20.5	20.5									22
24	18.8	18.4	18.3	18.4								24
26	17	16.8	16.7	16.7	16.5	14.5						26
28	15.6	15.4	15.3	15.3	15	14.3	12					28
30	14.3	14.3	14.1	14	13.8	13.8	11.8	9.9	8.4			30
32		13.1	13.1	12.9	12.8	12.7	11.6	9.7	8.2	6.9	5.8	32
34		12.3	12.1	12	11.9	11.8	11.4	9.5	8	6.7	5.6	34
36			11.3	11.2	11	10.9	10.9	9.4	7.8	6.5	5.4	36
38				10.5	10.4	10.2	10.1	9.2	7.6	6.3	5.3	38
40					9.6	9.5	9.3	9	7.4	6.2	5.1	40
42					9.1	8.9	8.8	8.3	7.3	6	4.9	42
44						8.4	8.2	7.6	6.9	5.9	4.8	44
46							7.8	7	6.4	5.6	4.6	46
48							7.1	6.5	5.9	5.2	4.5	48
50								5.9	5.4	4.8	4.1	50
52									4.9	4.3	3.7	52
54									4.4	3.9	3.3	54
56										3.5	2.9	56
58											2.6	58
60											2.3	60
Parts of line	3	3	3	2	2	2	2	1	1	1	1	Parts of line

LJ Load Chart

Load chart -LJ (Load on luffing jib hook, Without extension jib, 52t+20t full CW)

Boom 40m, Boom angle 75°												
BL (m) R (m)	22	25	28	31	34	37	40	43	46	49	52	BL (m) R (m)
22	18.1											22
24	16.3	16.3										24
26	14.9	14.7	14.6	14.5								26
28	13.7	13.5	13.4	13.2	13.1	12.9						28
30	12.6	12.5	12.4	12.1	12	11.8	11.2					30
32	11.7	11.5	11.4	11.3	11.1	10.9	10.7	9.3	7.9			32
34		10.6	10.6	10.4	10.2	10.1	9.9	9.2	7.7	6.5		34
36		9.9	9.8	9.7	9.5	9.4	9.2	9	7.6	6.4	5.3	36
38			9.1	9	8.9	8.7	8.6	8.4	7.4	6.2	5.2	38
40				8.4	8.3	8.2	8.1	7.9	7.3	6.1	5.1	40
42				7.9	7.8	7.6	7.5	7.4	7.2	5.9	4.9	42
44					7.3	7.2	7	6.9	6.8	5.8	4.8	44
46						6.8	6.6	6.4	6.3	5.7	4.6	46
48							6.3	6.1	5.9	5.5	4.5	48
50							5.8	5.7	5.5	5.3	4.4	50
52								5.4	5.3	4.8	4.1	52
54									4.9	4.4	3.8	54
56									4.6	4	3.4	56
58										3.6	3	58
60											2.7	60
62											2.4	62
Parts of line	3	3	3	2	2	2	2	1	1	1	1	Parts of line

Unit: t

LJ Load Chart

Load chart -LJ (Load on luffing jib hook, Without extension jib, 52t+20t full CW)

Boom 49m, Boom angle 75°												
BL (m) R (m)	22	25	28	31	34	37	40	43	46	49	52	BL (m) R (m)
24	14.5											24
26	13	12.9										26
28	12	11.9	11.6	11.5								28
30	11	10.8	10.8	10.5	10.4							30
32	10.2	10	9.9	9.7	9.5	9.4	9.2					32
34	9.5	9.2	9.1	9	8.8	8.6	8.4	8.3				34
36		8.7	8.5	8.4	8.2	8	7.8	7.7	7.1	6		36
38		8	7.9	7.7	7.6	7.5	7.2	7	6.9	5.9	5	38
40			7.5	7.3	7.1	6.9	6.7	6.6	6.5	5.8	4.9	40
42				6.8	6.6	6.5	6.4	6.2	6	5.7	4.7	42
44				6.3	6.2	6.1	5.9	5.7	5.6	5.4	4.6	44
46					5.8	5.7	5.5	5.3	5.2	5	4.5	46
48						5.4	5.2	5	4.9	4.7	4.4	48
50						5.1	4.8	4.7	4.6	4.4	4.2	50
52							4.6	4.4	4.3	4.2	3.9	52
54								4.2	4	3.9	3.8	54
56								3.9	3.8	3.6	3.5	56
58									3.6	3.4	3.2	58
60										3.2	3	60
62											2.8	62
64											2.4	64
Parts of line	3	3	3	2	2	2	2	1	1	1	1	Parts of line

LJ Load Chart**Load chart -LJ (Load on luffing jib hook, Without extension jib, 52t+20t full CW)**

Boom 22m, Boom angle 85°												
BL (m) R (m)	22	25	28	31	34	37	40	43	46	49	52	BL (m) R (m)
10	40											10
12	37.6	33.8	29.9	26.7								12
14	34.5	31.2	27.9	24.9	21.8	18.4						14
16	30.1	28.9	26	23.3	21.3	17.9	15.1	12.8	11			16
18	25.1	25.3	23.9	21.7	20.3	17.4	14.7	12.4	10.6	9.1	7.7	18
20	21.5	21.6	21.8	20.2	18.8	17	14.2	12	10.2	8.7	7.4	20
22	18.7	18.8	18.9	18.7	17.4	16.1	13.8	11.6	9.9	8.4	7.1	22
24	14.8	16.5	16.6	16.5	16	14.9	13.4	11.3	9.5	8.1	6.8	24
26		14.1	14.8	14.7	14.8	13.7	12.6	11	9.2	7.8	6.6	26
28			13.2	13.2	13.2	12.7	11.7	10.6	8.9	7.5	6.3	28
30			10.3	11.9	11.9	11.6	10.8	9.8	8.6	7.2	6	30
32				10.1	10.8	10.8	9.9	9.1	8.2	6.9	5.8	32
34					9.7	9.8	9.1	8.3	7.6	6.7	5.6	34
36					7.7	8.9	8.4	7.7	6.9	6.2	5.3	36
38						7.5	7.6	7	6.4	5.7	5	38
40							7	6.4	5.8	5.2	4.5	40
42							5.8	5.8	5.3	4.7	4.1	42
44								5.3	4.8	4.2	3.7	44
46									4.3	3.8	3.3	46
48									3.9	3.4	2.9	48
50										3.1	2.6	50
52											2.2	52
Parts of line	3	3	3	2	2	2	2	1	1	1	1	Parts of line

Unit: t

LJ Load Chart

Load chart -LJ (Load on luffing jib hook, Without extension jib, 52t+20t full CW)												
Boom 31m, Boom angle 85°												
BL (m) R (m)	22	25	28	31	34	37	40	43	46	49	52	BL (m) R (m)
12	37.1	33.3	28.8									12
14	32.1	31.1	27.6	23.9	20.2							14
16	27.6	27.5	26	23.2	19.8	16.8	14.3	12.2				16
18	24.3	24.2	24.1	21.8	19.4	16.4	13.9	11.9	10.2	8.7		18
20	21.7	21.6	21.3	20.6	18.9	16.1	13.6	11.6	9.9	8.4	7.2	20
22	19.5	19.4	19.2	19.1	17.6	15.7	13.2	11.2	9.6	8.1	6.9	22
24	17.7	17.6	17.4	17.3	16.4	15.1	12.9	10.9	9.3	7.9	6.7	24
26		16	15.9	15.6	15	14.1	12.6	10.6	9	7.6	6.4	26
28		13.3	14.2	14	13.6	13	12.1	10.3	8.7	7.3	6.2	28
30			12.4	12.4	12.3	11.9	11.2	10.1	8.4	7.1	5.9	30
32				11	11	10.9	10.4	9.4	8.2	6.8	5.7	32
34				9.8	9.9	9.9	9.6	8.8	7.9	6.6	5.5	34
36					8.9	9	8.8	8	7.3	6.4	5.3	36
38						8	8	7.4	6.7	6	5.1	38
40						7.2	7.3	6.8	6.2	5.5	4.8	40
42							6.6	6.2	5.7	5	4.3	42
44								5.7	5.2	4.6	3.9	44
46									4.7	4.2	3.5	46
48									4.2	3.7	3.2	48
50										3.3	2.8	50
52											2.5	52
54											2.1	54
Parts of line	3	3	3	2	2	2	2	1	1	1	1	Parts of line

LJ Load Chart

Load chart -LJ (Load on luffing jib hook, Without extension jib, 52t+20t full CW)

Boom 40m, Boom angle 85°												
R (m) \ BL (m)	22	25	28	31	34	37	40	43	46	49	52	BL (m) \ R (m)
12	32	28.5										12
14	28.8	27	24.3	21.1								14
16	25.1	24.7	23	20.7	17.8	15.3	13.2					16
18	21.9	21.8	21.5	19.6	17.5	15	12.9	11.1	9.6			18
20	19.7	19.4	19.3	18.2	16.8	14.7	12.6	10.8	9.3	8	6.8	20
22	17.8	17.5	17.3	16.9	15.7	14.5	12.4	10.6	9.1	7.7	6.6	22
24	16	15.9	15.7	15.5	14.6	13.6	12.1	10.3	8.8	7.5	6.4	24
26	14.6	14.4	14.3	14.2	13.5	12.7	11.8	10.1	8.6	7.3	6.2	26
28		13.2	13	12.8	12.4	11.8	11	9.8	8.3	7.1	6	28
30			11.7	11.5	11.3	10.9	10.3	9.6	8.1	6.8	5.8	30
32			10.3	10.4	10.2	10	9.6	9	7.9	6.6	5.6	32
34				9.2	9.3	9.1	8.8	8.4	7.7	6.4	5.4	34
36					8.4	8.3	8.1	7.8	7.4	6.2	5.2	36
38					7.5	7.6	7.4	7.3	6.9	6.1	5	38
40						6.8	6.8	6.7	6.4	5.7	4.8	40
42							6.2	6.2	5.9	5.2	4.5	42
44								5.6	5.4	4.7	4.1	44
46								5.1	5	4.3	3.7	46
48									4.4	3.9	3.3	48
50										3.5	3	50
52										3.2	2.7	52
54											2.3	54
Parts of line	3	3	3	2	2	2	2	1	1	1	1	Parts of line

Unit: t

LJ Load Chart

Load chart -LJ (Load on luffing jib hook, Without extension jib, 52t+20t full CW)

Boom 49m, Boom angle 85°												
BL (m) R (m)	22	25	28	31	34	37	40	43	46	49	52	BL (m) R (m)
14	24.4	22.3	20.3									14
16	22.7	21	19.3	17.5	15.4	13.4						16
18	20.1	19.5	18.2	16.7	15.1	13.2	11.5	10				18
20	18	17.9	16.9	15.8	14.5	13	11.3	9.8	8.5	7.4	6.4	20
22	16.3	16.1	15.7	14.6	13.7	12.6	11.1	9.6	8.3	7.2	6.2	22
24	14.7	14.5	14.4	13.5	12.8	12	10.8	9.4	8.1	7	6	24
26	13.5	13.3	13.1	12.4	11.9	11.2	10.4	9.2	7.9	6.8	5.8	26
28		12.1	11.9	11.5	11	10.5	9.8	9	7.7	6.6	5.6	28
30		10.9	10.7	10.4	10.1	9.7	9.2	8.6	7.5	6.4	5.4	30
32			9.7	9.5	9.3	9	8.6	8.1	7.4	6.2	5.3	32
34				8.6	8.5	8.3	8	7.6	7.1	6.1	5.1	34
36					7.7	7.6	7.4	7.1	6.7	5.9	4.9	36
38					7	7	6.8	6.6	6.3	5.7	4.8	38
40						6.4	6.3	6.1	5.9	5.6	4.6	40
42							5.7	5.6	5.5	5.2	4.5	42
44							5.3	5.2	5.1	4.9	4.2	44
46								4.8	4.7	4.5	3.9	46
48									4.3	4.1	3.5	48
50									4	3.7	3.1	50
52										3.3	2.8	52
54											2.5	54
56											2.2	56
Parts of line	3	3	3	2	2	2	2	1	1	1	1	Parts of line

LJ Load Chart**Load chart -LJ (Load on luffing jib hook, Without extension jib, 52t+20t full CW)**

Boom 22m, Boom angle 87°												
BL (m) R (m)	22	25	28	31	34	37	40	43	46	49	52	BL (m) R (m)
10	36.9	34.5										10
12	33.7	31.6	28.3	25.8								12
14	30.7	29.2	26.1	24.1	21.6	18.2						14
16	26	26.3	24.2	22.4	20.2	17.7	14.9	12.7	10.9			16
18	21.8	22.2	22.2	20.8	18.6	17.2	14.5	12.3	10.5	8.9	7.6	18
20	18.4	19	19.4	19.3	17.3	16	14	11.8	10.1	8.6	7.3	20
22	15.3	16.4	16.8	16.8	16	14.9	13.6	11.4	9.7	8.2	7	22
24	11.3	14.1	14.7	14.8	14.7	13.7	12.7	11.1	9.4	7.9	6.7	24
26		11.2	12.8	13	13.2	12.7	11.6	10.7	9	7.6	6.4	26
28			10.8	11.4	11.8	11.7	10.7	9.9	8.7	7.3	6.1	28
30				9.8	10.4	10.7	9.9	9.1	8.3	7	5.9	30
32				7.8	9.2	9.5	9.1	8.4	7.6	6.8	5.6	32
34					7.6	8.5	8.4	7.8	7	6.3	5.4	34
36						7.3	7.7	7.2	6.5	5.7	5	36
38							5.9	6.9	6.5	5.9	5.2	38
40								5.7	5.9	5.4	4.7	40
42									5.3	4.9	4.3	42
44									4.4	4.5	3.9	44
46										4.3	3.5	46
48											3.2	48
50											3.2	50
52												52
Parts of line	3	3	3	2	2	2	2	1	1	1	1	Parts of line

Unit: t

LJ Load Chart

Load chart -LJ (Load on luffing jib hook, Without extension jib, 52t+20t full CW)

Boom 31m, Boom angle 87°												
BL (m) R (m)	22	25	28	31	34	37	40	43	46	49	52	BL (m) R (m)
10	36.2											10
12	33.4	31.1	27.7									12
14	30.9	28.9	25.8	23.6	20	17						14
16	27.2	26.9	24.1	22.3	19.5	16.5	14.1	12				16
18	22.7	23.1	22.5	20.7	18.7	16.1	13.7	11.7	10	8.6	7.3	18
20	19.1	19.7	20.1	19.2	17.5	15.7	13.3	11.3	9.7	8.3	7	20
22	17.3	16.9	17.4	17.4	16.2	14.9	13	11	9.4	8	6.8	22
24	14.1	14.5	15.1	15.2	15	13.9	12.6	10.7	9.1	7.7	6.5	24
26		13.3	13.2	13.4	13.6	13	11.9	10.4	8.8	7.4	6.3	26
28			12.3	11.7	12.1	12	11	10.1	8.5	7.1	6	28
30			10.3	11.1	10.7	10.9	10.2	9.4	8.2	6.9	5.8	30
32				9.6	10.2	9.8	9.5	8.7	7.9	6.6	5.5	32
34					8.9	8.7	8.8	8	7.3	6.4	5.3	34
36					7.3	8.3	8	7.4	6.7	6	5.1	36
38						7.3	7.4	6.8	6.2	5.4	4.8	38
40							6.8	6.3	5.7	5	4.3	40
42								5.7	5.2	4.6	3.9	42
44								5.2	4.8	4.2	3.5	44
46									4.8	3.8	3.2	46
48										3.4	2.9	48
50										3.4	2.5	50
52											2.2	52
Parts of line	3	3	3	2	2	2	2	1	1	1	1	Parts of line

LJ Load Chart**Load chart -LJ (Load on luffing jib hook, Without extension jib, 52t+20t full CW)**

Boom 40m, Boom angle 87°												
BL (m) R (m)	22	25	28	31	34	37	40	43	46	49	52	BL (m) R (m)
12	29.6	26.6	23.8									12
14	27.1	24.8	22.6	20.4	17.8							14
16	24.6	22.8	21.1	19.2	17.4	15	13	11.2				16
18	21.9	20.8	19.4	18	16.5	14.7	12.6	10.9	9.4	8.1		18
20	19.5	18.8	17.8	16.7	15.4	14.1	12.3	10.6	9.1	7.8	6.7	20
22	17.4	16.9	16.2	15.3	14.3	13.3	12	10.3	8.8	7.6	6.5	22
24	15.1	15.1	14.7	14.1	13.3	12.5	11.5	10	8.6	7.3	6.2	24
26		13.5	13.2	12.8	12.2	11.6	10.8	9.8	8.3	7.1	6	26
28			11.9	11.6	11.2	10.8	10.1	9.4	8.1	6.8	5.8	28
30			10.7	10.5	10.3	9.9	9.5	8.9	7.8	6.6	5.6	30
32				9.6	9.4	9.1	8.8	8.3	7.6	6.4	5.4	32
34					8.5	8.4	8.1	7.7	7.3	6.2	5.2	34
36					7.8	7.6	7.5	7.2	6.9	6	5	36
38						7.1	6.9	6.7	6.4	5.6	4.8	38
40							6.4	6.2	5.8	5.1	4.4	40
42							6.1	5.7	5.3	4.6	4	42
44								5.3	4.9	4.3	3.7	44
46									4.5	3.9	3.3	46
48									4.1	3.5	3	48
50										3.5	2.6	50
52											2.3	52
54											2.3	54
Parts of line	3	3	3	2	2	2	2	1	1	1	1	Parts of line

Unit: t

LJ Load Chart

Load chart -LJ (Load on luffing jib hook, Without extension jib, 52t+20t full CW)												
Boom 49m, Boom angle 87°												
BL (m) R (m)	22	25	28	31	34	37	40	43	46	49	52	BL (m) R (m)
12	23.8	21.8										12
14	22.2	20.5	18.7	17	15.3							14
16	20.4	19.1	17.7	16.3	14.9	13.1	11.5					16
18	18.6	17.5	16.4	15.3	14	12.8	11.2	9.8	8.5	7.4		18
20	16.8	16	15.2	14.2	13.2	12.2	10.9	9.5	8.3	7.2	6.2	20
22	15.2	14.6	13.9	13.2	12.4	11.6	10.6	9.3	8.1	7	6	22
24	13.8	13.2	12.8	12.2	11.6	10.8	10	9.1	7.8	6.8	5.8	24
26		12	11.6	11.2	10.7	10.1	9.5	8.8	7.6	6.6	5.6	26
28		10.9	10.6	10.2	9.9	9.4	8.9	8.3	7.4	6.4	5.4	28
30			9.7	9.4	9.1	8.8	8.3	7.8	7.3	6.2	5.2	30
32				8.6	8.3	8.1	7.8	7.4	6.9	6	5.1	32
34				7.9	7.7	7.5	7.2	6.9	6.5	5.8	4.9	34
36					7.1	6.9	6.7	6.4	6.1	5.6	4.7	36
38						6.3	6.2	6	5.7	5.4	4.6	38
40						5.9	5.7	5.5	5.4	5.1	4.4	40
42							5.7	5.1	5	4.8	4.1	42
44								4.8	4.6	4.4	3.7	44
46									4.3	4	3.3	46
48									4	3.6	3	48
50										3.6	2.7	50
52											2.4	52
54											2.4	54
Parts of line	3	3	3	2	2	2	2	1	1	1	1	Parts of line

LJCZG Working Radius

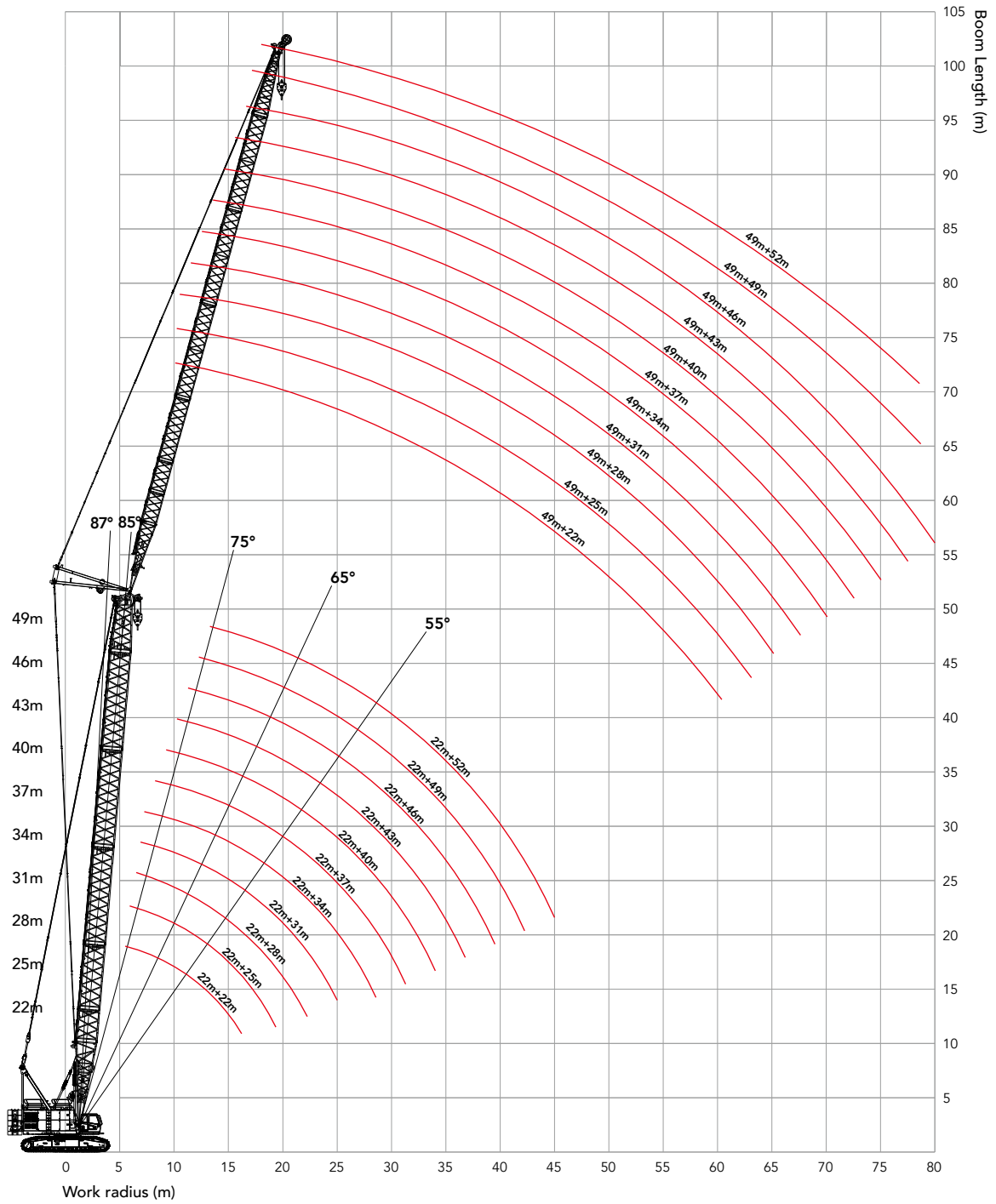

Unit: t

LJCZG Load Chart

Load chart -LJCZG (double hooks, load on main hook, boom 49m, 52t+20t full CW)

Jib 22m											
BL (m) R (m)	22	25	28	31	34	37	40	43	46	49	BL (m) R (m)
4.5	85.9										4.5
5	86.4	86.7	87.3								5
5.5	87.5	87.9	88.1	87.9	80.1						5.5
6	88.7	89.1	88.8	88.4	78.2	70.1	62.9				6
6.5	89.4	89.7	89.7	86.2	76.8	68.8	61.7	55.5	50.2		6.5
7	90.1	90.4	90.5	84	75.3	67.5	60.5	54.7	49.4	44.3	7
8	78.9	79.5	77.2	74.7	72.1	64.8	58.3	53	47.8	42.8	8
9	66.9	67.8	66	64.1	62.3	60.5	56.4	51.3	46.2	41.6	9
10	56.7	58.2	57.2	55.7	54.3	52.8	50.7	47.6	44.6	40.4	10
12	42.1	43.5	44.4	43.4	42.4	40.5	38	36	34.3	32.4	12
14	32.1	33.4	34.4	34.5	32.7	31.2	29.4	28.1	26.3	24.9	14
16	24.8	26	27	27.2	25.7	24.7	23.3	22.1	20.6	19.5	16
18	19.2	20.4	21.4	21	20.3	19.3	18.2	17.2	16.4	15.3	18
20	12.2	15.1	16.3	16.3	15.7	15.1	14.4	13.5	12.6	11.8	20
22		9.6	11.6	11.9	12	11.8	11.1	10.4	9.6	8.9	22
24			7.2	8.4	8.7	8.7	8.4	7.7	7.3	6.4	24
26			3.1	5	5.8	5.9	5.7	5.5	5.2	4.3	26
28				1.8	3.1	3.6	3.6	3.5	3.3	2.6	28
30						1.4	1.6	1.6	1.4	1	30

Load chart -LJCZG (double hooks, load on main hook, boom 49m, 52t+20t full CW)

Jib 25m											
BL (m) R (m)	22	25	28	31	34	37	40	43	46	49	BL (m) R (m)
4.5	83.3										4.5
5	83.9	84.3	85								5
5.5	85.1	85.6	85.8	85.7	78						5.5
6	86.4	86.9	86.7	86.4	76.2	68.2	60.9				6
6.5	87.2	87.6	87.6	84.2	74.8	66.9	59.8	53.7	48.4		6.5
7	87.9	88.3	88.5	82	73.4	65.6	58.7	53	47.7	42.6	7
8	77.5	78.2	75.8	73.4	70.4	63.1	56.7	51.3	46.2	41.2	8
9	65.5	66.5	64.7	62.9	61.1	59.4	54.8	49.7	44.6	40.1	9
10	55.4	57	56	54.5	53.2	51.7	49.1	46.1	43.1	39	10
12	40.9	42.3	43.2	42.3	41	39	36.6	34.6	32.9	31	12
14	30.9	32.2	33.3	32.9	31.2	29.8	28	26.7	25	23.6	14
16	23.6	24.9	26	25.7	24.3	23.3	21.9	20.7	19.4	18.2	16
18	18	19.3	20.2	19.5	18.9	18	16.8	15.9	15.1	14.1	18
20	10.5	13.5	14.8	14.9	14.3	13.8	13.1	12.2	11.3	10.6	20
22		8	10.1	10.5	10.6	10.4	9.8	9.2	8.4	7.7	22
24			5.7	7	7.3	7.4	7.1	6.5	6.1	5.3	24
26			1.7	3.7	4.5	4.6	4.5	4.3	4	3.2	26
28					1.8	2.3	2.4	2.3	2.1	1.5	28

LJCZG Load Chart**Load chart -LJCZG (double hooks, load on main hook, boom 49m, 52t+20t full CW)**

Jib 28m											
BL (m) R (m)	22	25	28	31	34	37	40	43	46	49	BL (m) R (m)
4.5	80.8										4.5
5	81.6	82.2	82.8								5
5.5	83	83.6	83.9	83.8	76.1						5.5
6	84.3	84.9	84.8	84.5	74.4	66.4	59.2				6
6.5	85.2	85.7	85.8	82.5	73.1	65.2	58.2	52.1	46.8		6.5
7	86	86.5	86.7	80.4	71.8	64	57.2	51.4	46.2	41.1	7
8	76.3	76.9	74.6	72.3	68.8	61.6	55.2	49.9	44.8	39.8	8
9	64.3	65.2	63.5	61.8	60.1	58.4	53.4	48.4	43.3	38.8	9
10	54.3	55.9	54.9	53.5	52.2	50.6	47.8	44.8	41.8	37.8	10
12	39.8	41.3	42.2	41.3	39.6	37.7	35.3	33.4	31.7	29.9	12
14	29.9	31.3	32.4	31.6	30	28.6	26.9	25.6	23.9	22.5	14
16	22.6	24	25.1	24.4	23.1	22.2	20.8	19.7	18.3	17.2	16
18	16.8	18.4	19	18.3	17.8	16.8	15.8	14.8	14.1	13.1	18
20	9	12.1	13.5	13.7	13.1	12.7	12	11.2	10.3	9.6	20
22		6.7	8.9	9.3	9.5	9.4	8.8	8.2	7.4	6.8	22
24			4.5	5.9	6.2	6.3	6.1	5.5	5.1	4.3	24
26				2.5	3.4	3.6	3.5	3.3	3.1	2.3	26
28						1.3	1.4	1.4	1.2		28

Load chart -LJCZG (double hooks, load on main hook, boom 49m, 52t+20t full CW)

Jib 31m											
BL (m) R (m)	22	25	28	31	34	37	40	43	46	49	BL (m) R (m)
4.5	78										4.5
5	78.9	79.6	80.3								5
5.5	80.4	81.1	81.5	81.4	73.8						5.5
6	81.9	82.5	82.5	82.3	72.3	64.3	57.1				6
6.5	82.8	83.4	83.6	80.3	71.1	63.2	56.2	50.2	44.9		6.5
7	83.7	84.3	84.6	78.3	69.8	62.1	55.3	49.6	44.3	39.3	7
8	74.8	75.4	73.2	71	66.9	59.8	53.4	48.1	43.1	38.1	8
9	62.9	63.8	62.2	60.5	58.8	57.2	51.7	46.7	41.7	37.2	9
10	52.9	54.6	53.5	52.3	51	48.9	46.2	43.2	40.3	36.2	10
12	38.5	40	40.9	40.1	38	36.1	33.8	31.9	30.3	28.4	12
14	28.6	30.1	31.3	30	28.4	27	25.4	24.1	22.5	21.1	14
16	21.4	22.8	23.6	22.8	21.6	20.7	19.4	18.3	17	15.9	16
18	15	16.7	17.3	16.8	16.3	15.4	14.4	13.5	12.8	11.8	18
20	7.3	10.5	11.9	12.2	11.7	11.3	10.7	9.9	9.1	8.4	20
22		5.1	7.3	7.9	8.1	8	7.5	6.9	6.2	5.6	22
24			3	4.4	4.9	5	4.8	4.3	3.9	3.1	24
26				1.1	2	2.2	2.2	2.1	1.9	1.1	26

Unit: t

LJCZG Load Chart

Load chart -LJCZG (double hooks, load on main hook, boom 49m, 52t+20t full CW)

Jib 34m											
BL (m) R (m)	22	25	28	31	34	37	40	43	46	49	BL (m) R (m)
4.5	75.2										4.5
5	76.3	77.1	77.9								5
5.5	78	78.7	79.2	79.2	71.6						5.5
6	79.5	80.3	80.4	80.2	70.2	62.3	55.2				6
6.5	80.5	81.2	81.5	78.3	69.1	61.3	54.3	48.3	43.1		6.5
7	81.4	82.2	82.6	76.3	67.9	60.2	53.4	47.8	42.6	37.6	7
8	73.4	73.9	71.8	69.7	65.2	58	51.7	46.5	41.5	36.5	8
9	61.6	62.4	60.8	59.3	57.7	56.1	50.1	45.1	40.1	35.7	9
10	51.6	53.4	52.3	51.1	49.8	47.4	44.7	41.7	38.8	34.8	10
12	37.2	38.9	39.7	38.6	36.5	34.7	32.4	30.5	28.9	27.1	12
14	27.4	29	30.1	28.5	27	25.6	24	22.8	21.2	19.9	14
16	20.2	21.7	22.1	21.4	20.2	19.4	18.1	17	15.7	14.7	16
18	13.3	15.1	15.8	15.3	14.9	14.1	13.1	12.3	11.6	10.6	18
20	5.6	8.9	10.5	10.8	10.4	10	9.4	8.7	7.9	7.3	20
22		3.6	5.9	6.5	6.8	6.8	6.3	5.7	5	4.5	22
24			1.6	3.1	3.6	3.8	3.7	3.1	2.8	2.1	24
26						1	1	1			26

Load chart -LJCZG (double hooks, load on main hook, boom 49m, 52t+20t full CW)

Jib 37m											
BL (m) R (m)	22	25	28	31	34	37	40	43	46	49	BL (m) R (m)
4.5	72.5										4.5
5	73.8	74.6	75.5								5
5.5	75.5	76.4	76.9	77	69.5						5.5
6	77.1	78	78.2	78.1	68.2	60.3	53.2				6
6.5	78.2	79.1	79.4	76.3	67.2	59.4	52.5	46.5	41.3		6.5
7	79.3	80.1	80.6	74.4	66	58.4	51.7	46.1	40.9	35.9	7
8	72	72.5	70.4	68.4	63.4	56.3	50.1	44.9	39.9	35	8
9	60.2	61	59.6	58	56.5	54.6	48.5	43.6	38.7	34.3	9
10	50.3	52.1	51.1	49.9	48.3	45.8	43.2	40.3	37.4	33.4	10
12	36	37.7	38.6	37.1	35	33.2	31	29.2	27.6	25.8	12
14	26.2	27.9	28.5	27	25.6	24.3	22.7	21.5	20	18.7	14
16	19.1	20.7	20.6	20	18.8	18.1	16.8	15.8	14.5	13.5	16
18	11.6	13.5	14.4	14	13.6	12.9	11.9	11.1	10.4	9.5	18
20	4	7.4	9.1	9.4	9.1	8.8	8.3	7.6	6.8	6.2	20
22		2.1	4.5	5.2	5.5	5.6	5.1	4.6	3.9	3.4	22
24				1.8	2.4	2.6	2.5	2	1.8	1	24

LJCZG Load Chart**Load chart -LJCZG (double hooks, load on main hook, boom 49m, 52t+20t full CW)**

Jib 40m											
BL (m) R (m)	22	25	28	31	34	37	40	43	46	49	BL (m) R (m)
4.5	69.2										4.5
5	70.7	71.6	72.6								5
5.5	72.6	73.6	74.2	74.4	66.9						5.5
6	74.3	75.4	75.6	75.6	65.8	57.9	50.9				6
6.5	75.5	76.5	77	73.9	64.8	57.1	50.3	44.3	39.1		6.5
7	76.6	77.6	78.2	72.1	63.8	56.2	49.5	43.9	38.8	33.8	7
8	70.4	70.8	68.8	66.8	61.3	54.3	48.1	42.9	38	33.1	8
9	58.6	59.4	58	56.6	55.1	52.6	46.6	41.7	36.8	32.5	9
10	48.7	50.5	49.6	48.5	46.4	43.9	41.3	38.5	35.7	31.7	10
12	34.5	36.3	37.2	35.2	33.2	31.5	29.3	27.5	26	24.2	12
14	24.8	26.5	26.6	25.2	23.8	22.6	21.1	19.9	18.4	17.1	14
16	17.7	18.8	18.7	18.2	17.1	16.4	15.2	14.3	13	12.1	16
18	9.6	11.6	12.6	12.2	12	11.3	10.4	9.6	9	8.1	18
20	2	5.5	7.3	7.8	7.5	7.3	6.8	6.1	5.4	4.8	20
22			2.8	3.5	4	4	3.6	3.2	2.6	2.1	22
24						1.1	1.1				24

Load chart -LJCZG (double hooks, load on main hook, boom 49m, 52t+20t full CW)

Jib 43m											
BL (m) R (m)	22	25	28	31	34	37	40	43	46	49	BL (m) R (m)
4.5	66.1										4.5
5	67.8	68.8	69.9								5
5.5	69.8	70.9	71.7	71.9	64.5						5.5
6	71.7	72.8	73.2	73.2	63.4	55.7	48.7				6
6.5	73	74.1	74.6	71.6	62.6	55	48.2	42.3	37.1		6.5
7	74.2	75.2	75.9	69.9	61.7	54.2	47.5	42	36.9	31.9	7
8	68.8	69.1	67.3	65.4	59.3	52.4	46.2	41.1	36.2	31.3	8
9	57.1	57.8	56.6	55.2	53.8	50.8	44.8	40	35.1	30.8	9
10	47.3	49	48.2	47.2	44.6	42.2	39.7	36.8	34	30.1	10
12	33.1	35	35.8	33.4	31.5	29.8	27.7	26	24.5	22.8	12
14	23.5	25.3	24.9	23.5	22.2	21.1	19.6	18.5	17	15.8	14
16	15.9	17	17	16.6	15.6	14.9	13.8	12.9	11.7	10.7	16
18	7.7	9.9	10.9	10.7	10.5	9.8	9	8.3	7.7	6.8	18
20		3.8	5.7	6.2	6	5.9	5.4	4.8	4.1	3.6	20
22			1.2	2	2.5	2.7	2.3	1.9	1.3		22

Unit: t

LJCZG Load Chart

Load chart -LJCZG (double hooks, load on main hook, boom 49m, 52t+20t full CW)

Jib 46m											
BL (m) R (m)	22	25	28	31	34	37	40	43	46	49	BL (m) R (m)
4.5	63										4.5
5	64.9	66	67.2								5
5.5	67.1	68.3	69.1	69.4	62.1						5.5
6	69.1	70.3	70.8	70.9	61.2	53.4	46.5				6
6.5	70.4	71.7	72.3	69.4	60.4	52.9	46.1	40.2	35.1		6.5
7	71.7	72.9	73.7	67.8	59.6	52.2	45.5	40	35	30.1	7
8	67.2	67.5	65.8	64	57.4	50.5	44.4	39.3	34.4	29.6	8
9	55.6	56.3	55.1	53.8	52	49	43.1	38.3	33.5	29.2	9
10	45.8	47.6	46.8	45.9	42.8	40.5	38	35.2	32.5	28.6	10
12	31.8	33.8	34	31.7	29.8	28.3	26.2	24.5	23	21.3	12
14	22.2	23.9	23.1	21.9	20.6	19.6	18.2	17.1	15.6	14.4	14
16	14	15.2	15.4	15	14.1	13.5	12.4	11.5	10.4	9.5	16
18	5.8	8.2	9.3	9.2	9	8.4	7.6	7	6.4	5.6	18
20		2.2	4.1	4.8	4.6	4.5	4.1	3.6	2.9	2.4	20
22					1.2	1.4	1.1				22

Load chart -LJCZG (double hooks, load on main hook, boom 49m, 52t+20t full CW)

Jib 49m											
BL (m) R (m)	22	25	28	31	34	37	40	43	46	49	BL (m) R (m)
4.5	59.4										4.5
5	61.5	62.8	64								5
5.5	63.9	65.2	66.1	66.5	59.2						5.5
6	66	67.4	67.9	68.1	58.5	50.8	43.9				6
6.5	67.5	68.8	69.6	66.8	57.9	50.3	43.6	37.8	32.7		6.5
7	68.8	70.2	71.1	65.2	57.1	49.7	43.2	37.7	32.7	27.8	7
8	65.4	65.6	64	62.3	55	48.2	42.1	37.1	32.3	27.5	8
9	53.9	54.5	53.4	52.2	49.8	46.9	41	36.3	31.5	27.2	9
10	44.1	45.8	45.1	44.3	40.7	38.4	36	33.3	30.6	26.7	10
12	30.1	32.2	31.8	29.6	27.8	26.3	24.3	22.7	21.3	19.6	12
14	20.6	21.6	21	19.9	18.7	17.7	16.4	15.4	14	12.8	14
16	11.7	13.1	13.4	13.1	12.2	11.7	10.7	9.9	8.8	7.9	16
18	3.6	6.1	7.4	7.3	7.2	6.7	6	5.4	4.9	4.1	18
20			2.2	2.9	2.9	2.8	2.5	2	1.4		20

LJCZG Load Chart

Load chart -LJCZG (double hooks, load on main hook, boom 49m, 52t+20t full CW)

Jib 52m											
BL (m) R (m)	22	25	28	31	34	37	40	43	46	49	BL (m) R (m)
4.5	55.7										4.5
5	58	59.4	60.7								5
5.5	60.5	62	63	63.5	56.3						5.5
6	62.8	64.3	64.9	65.3	55.7	48	41.2				6
6.5	64.3	65.9	66.7	64	55.2	47.7	41.1	35.3	30.2		6.5
7	65.8	67.3	68.3	62.6	54.5	47.2	40.7	35.3	30.3	25.5	7
8	63.5	63.6	62.1	60	52.6	45.8	39.8	34.9	30.1	25.3	8
9	52	52.6	51.6	50.5	47.5	44.6	38.8	34.2	29.4	25.2	9
10	42.3	44	43.4	42.1	38.5	36.3	33.9	31.2	28.6	24.7	10
12	28.4	30.6	29.5	27.4	25.8	24.3	22.3	20.8	19.4	17.8	12
14	19	19.4	18.9	17.8	16.7	15.8	14.5	13.6	12.2	11.1	14
16	9.3	10.8	11.3	11.1	10.3	9.9	8.9	8.1	7.1	6.3	16
18	1.3	3.9	5.3	5.4	5.4	4.9	4.3	3.7	3.2	2.5	18
20				1	1	1.1					20



Zhejiang Sany Equipment Co.,LTD

SANY Crawler Crane Industrial Park, No. 2188 Daishan Road, Wuxing District, Huzhou City,
Zhejiang Province, P. R. China Zip 313028
Consulting sanycrane@sanygroup.com (Crane BU) / crd@sany.com.cn (IHQ)
After-sales Service 0086-400 6098 318

Reminder:

Any change in the technical parameters and configuration due to product modification or upgrade may occur without prior notice.
The machine in the picture may include additional equipment. This brochure is for reference only, and goods in kind shall prevail.
Copyright at SANY. No part of this brochure may be copied or used for any purpose without written approval from SANY.

© Edited in March 2023

