



SCE4000A-1

SANY Crawler Crane

400Tons Lifting Capacity

Quality Changes the World



Max. lifting moment: $333 \times 16 = 5,328 \text{t}\cdot\text{m}$

Longest boom: 84m

Longest boom+luffing jib: 84m+81m

The parameters, pictures and standard/optional equipment are only for reference in this brochure, the actual machine is based on the effective price list and contract.

■ www.sanyglobal.com



Crawler Crane Series
SCE4000A-1

P03	Main Characteristics	<ul style="list-style-type: none"> ▪ Product Specification ▪ Safety Devices
P09	Technical Parameters	<ul style="list-style-type: none"> ▪ Major Performance & Specifications ▪ Outline Dimension ▪ Transport Dimensions ▪ Transport Plan ▪ Self-Assembly Plan
P29	Configurations	<ul style="list-style-type: none"> ▪ Configurations ▪ H Configuration ▪ HDB Configuration ▪ HJ Configuration ▪ HJDB Configuration ▪ HJFJ Configuration ▪ FJh Configuration ▪ FJhDB Configuration ▪ LJ Configuration ▪ LJDB Configuration



SCE4000A-1
SANY CRAWLER CRANE
400TONS LIFTING CAPACITY

QUALITY CHANGES THE WORLD

Main Characteristics

- Page 04 Product Specification
- Page 07 Safety Devices



Product Specification



Cab

- Appearance: The industrial modeling of the cab is designed by Porsche. It has a smooth, elegant and novel appearance, with brand identification, which is a significant breakthrough when compared with traditional engineering machinery. The cab is fitted with sliding door structure, which is suitable for the crawler crane and convenient for the operator. It is adopted with fully-sealed steel frame structure, with a large area of high strength toughened glass installed on the front, side and top, more light-transmitting. The interior space of the cab is spacious and bright, with a broader sight view.
- The suspended seat is shock and noise absorbing, and multi-mode and multi-stage adjustable, thus providing most comfortable driving experience. The famous USA RedDot air conditioner is adopted, with reasonable air outlet and efficient cooling. It takes no more than 20 min to cool the cab from 55°C to 27.5°C. The left and right armrest boxes and auxiliary control boxes are equipped with control handles, control buttons, ignition locks and other components. The seats, control handles and control buttons are arranged according to ergonomic design, fully considering the driver's operation demands and habits. The control box can be adjusted, with the seat, to the most desirable position, bringing more comfortable operation. The cab can tilt up to 25° according to the work demands, and can also rotate to the front part of the rotating bed for the convenience of transport.

Engine

- Cummins X12-C400 Stage V.
- Rated power: 298kW.
- Rated speed: 2,100rpm.
- Max. output torque: 2,169N·m.
- Speed at maximum output torque: 1,400rpm.

Main and Auxiliary Load Hoisting Mechanism

- A variable hydraulic motor drives the planetary gear reducer to control the load lifting and lowering of main and aux. hoist winches. A good inching performance is provided. The high-speed mode can realize main and aux. load lifting faster.
- Variable hydraulic motor can realize max. winch speed through displacement adjustment based on electricity flow.
- High-quality spin-resistance wire rope to make sure high safety and longer service life.
- Fold-line machined drum provides high precision and good reliability, making sure the wire rope won't get messy.
- The wire rope lug adopted to make wire rope assembly easier and faster.

Main load hoist mechanism	Drum diameter	626mm
	Rope speed on the outermost work layer	0~140m/min
	Steel rope diameter	26mm
	Steel rope length of main load hoist	900m
Aux. load hoist mechanism	Drum diameter	626mm
	Rope speed on the outermost work layer	0~140m/min
	Steel rope diameter	26mm
	Steel rope length of aux. load hoist	900m
	Rated tension of single rope	15t

Boom/Jib/Hoist Mechanism

- Including: luffing mechanisms of the boom, jib and superlift;
- Drums with fold-line grooves are adopted for all luffing devices. Hydraulic motor drives the planetary gear reducer to realize a number of compound functions and good inching performance.

Boom Luffing mechanism	Drum diameter	641mm
	Rope speed on the outermost work layer	(0~65)×2m/min
	Steel rope diameter	26mm
	Steel rope length of boom hoist	550m
Jib luffing mechanism	Drum diameter	641mm
	Rope speed on the outermost work layer	0~100m/min
	Steel rope diameter	26mm
	Steel rope length of jib luffing	660m
Superlift mast luffing	Drum diameter	641mm
	Rope speed on the outermost work layer	0~100m/min
	Steel rope diameter	26mm
	Steel rope length of superlift luffing	860m



Product Specification

Slewing Mechanism

- The slewing hydraulic system adopts double motor to drive the spur gear through the planetary gear box, which can realize 360° rotation, slewing speed of 0~1.4rpm, stepless speed regulation, no backlash at starting or stopping, stable operation and free slipping function at neutral position.
- Slewing ring: It is adopted with three-row roller type slewing bearing with external gears.

Carbody

- The hydraulic cylinder drives power pin to be connected with track frame to facilitate the assembly and disassembly. Frame structures are welded by high-strength steel. Larger chassis design greatly improves the stability of the crane. The self-assembled carbody counterweight is 40t, with 20t at both front and the rear.

Track Assembly

- Track frame: each track frame is equipped with an independent travel driving device. A hydraulic travel motor drives the planetary gear reducer and realizes independent traveling through the transmission of driving wheel. The travel system is configured with high and low speeds: sufficient traction is provided in low speed to realize travel with 100% load, the high speed can provide higher speed to improve the transit efficiency. The traveling drive can also realize stepless speed change.
- Track shoe: It is made of materials with high strength and high wear resistance through advanced casting process. After being installed on the equipment, its tension can be adjusted through the hydraulic jack, and the shim position can be adjusted to achieve the ideal tension.

Counterweight

- Counterweight include carbody counterweight , rear counterweight, superlift counterweight, and the details are listed below:

Name	Quantity	Length (m)	Width (m)	Height (m)	Unit Weight (t)
Carbody Counterweight	4	5.80	1.70	0.33	10
Rear Counterweight(10t)	12	2.85	2.40	0.49	10
Rear Counterweight Tray	2	3.20	2.83	1.80	15
Superlift Counterweight (10t)	20	2.85	2.40	0.49	10
Superlift Counterweight Tray	1	9.95	2.70	2.20	9

Operation equipment

- High-strength steel tubes and plates are adopted.

Boom

- The boom is a spatial lattice structure of welded tubes with equal section areas of inserts and tapered sections for two ends. The boom top and root are strengthened with steel plates, which is easier for load transfer.
- The boom length ranges from the that of basic boom 24m to max. length 84m.
- Composition: boom base 12m×1, tapered insert 10.5m×1, connecting tip (boom tip) 1.5m×1, insert section 6m×2, and insert section 12m×4.
- The extension jib shall be installed on the boom top.

Short Heavy Jib(for wind energy and shield lifting)

- The short heavy jib is a spatial lattice structure of welded tubes with equal section areas of inserts and tapered sections for two ends. The boom top and root are strengthened with steel plates, which is easier for load transfer. The jib is 9m long and can be used for both wind energy and shield lifting.
- Composition: Jib base 4.5m×1, Jib top 4.5m×1.

Product Specification



Luffing Jib

- The jib is a spatial lattice structure of welded tubes with equal section areas of inserts and tapered sections for two ends. The boom top and root are strengthened with steel plates, which is easier for load transfer.
- The length of the luffing jib ranges from 21m to 81m, increased by every 6m.
- Composition: jib base 4.5m×1, jib insert 6m×2, 12m jib insert A×1, 12m jib insert B×4, jib top 4.5m×1.
- The extension jib shall be installed on the luffing jib top.

Superlift Device

- The superlift mast is a spatial lattice structure of welded tubes with equal section areas of inserts and tapered sections for two ends. The boom top and root are strengthened with steel plates, which are easier for load transfer.
- The superlift mast is 30m long.
- Composition: mast base 12m×1, insert section 6m×1, and mast top 12m×1.

Hook

- 5 kinds of hooks are available, and specific parameters are as follows:

Name of Hook	Max. Lifting Capacity	Quantity	Pulleys	Unit Weight
400t hook	400t	1	2×9	10.5t
260t hook	260t	1	9	4.8t
160t hook	160t	1	5	3.8t
50t hook	50t	1	1	1.7t
16t ball hook	16t	1	-	0.9t

- The hook height limit:

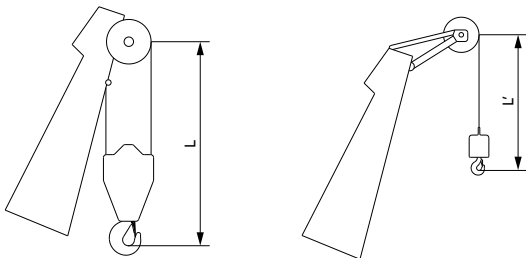

Hook	Length (m)
400t hook	7.6
260t hook	6.4
160t hook	6.2
50t hook	5.6

Hook	Length (m)
16t hook	4.6

Hydraulic System

- The whole hydraulic system includes that of hoisting, traveling, slewing, luffing, servo, back-stop, cooling system, and auxiliary hydraulic system. Major hydraulic components are of famous brand.
- Features: lifting, traveling, luffing, and slewing hydraulic systems are applied with open circuits, which has advantages such as energy saving, high efficiency, quick response, low heat generation and long service life.
- Electrically-controlled proportional control components are adopted for the servo system to realize precise and intelligent control.
- The back-stop hydraulic system adopts balance valve of external control and unloading, and it is mounted on the cylinder to make sure it is safe and reliable.
- The cooling hydraulic system is featured with large heat exchange power and good cooling effect.

Operating Weight

- The operating weight is about 340t, including the upperworks, lowerworks, rear counterweight of basic machine, carbody counterweight, 24m basic boom and 400t hook.

Ground Pressure

- The average ground pressure of machine with basic boom is 0.167MPa.

Gradeability

- The gradeability of machine with basic boom is 15%.



Safety Devices

Load Moment Indicator

- The proprietary load moment indicator independently developed by Sany is adopted, which forms a network with other controllers through CAN bus line, so as to realize safe and reliable control. The load moment indicator can automatically detect the hoisting weight of the crane and the angle of the boom, and display the rated load capacity, actual load, working radius, and the allowable height of the hook.
- The load moment indicator system consists of a large-screen color display, a host computer, angle sensors, tension sensors, pressure sensors and other components.

Over-hoist Protection of the Main and Auxiliary Hooks

- It is used to prevent the over-hoist of the hook. When the lifting hook is raised to a certain height, the limit switch will start working, and hook will be automatically cut off from moving up by the control system. Meanwhile, the display and the buzzer will give alarms. At this moment, only hook lowering is allowed to prevent over-hoist action.

Over-release Protection Device of the Main and Auxiliary Hook

- It is used to prevent the wire rope over-release. When the wire rope is released to the last three wraps, the limit switch will start working, and the releasing of rope will be automatically stopped by the control system. Meanwhile, the display and the buzzer will give alarms. At this moment, only rope retraction is allowed to prevent over release action.

Assembly/Work Mode Switchover

- In Assembly Mode, some of the safety devices cannot function properly, such as jib limit, boom angle limit in LML, and overload, so as to facilitate the crane assembly.
- In Work Mode, all safety devices can function properly.

Boom Angle Limit

- When the elevation angle of the boom exceeds 85° or jib angle exceeds 75° , corresponding limit switch will be triggered, and the control system will automatically cut off the boom hoisting. Meanwhile, the display and the buzzer will give alarm. At this moment, boom/jib luffing winch won't hoist but it can still lower down.
- When the boom down angle is less than 30° or jib down angle is less than 15°, the control system will automatically cut off the boom/jib from further lowering. Meanwhile, the display and the buzzer will give alarms. At this moment, boom/jib luffing winch won't be able to lower. This protection is automatically controlled by Load Moment Limiter.

Back-stop Device

- The boom and the superlift mast are respectively equipped with a pair of back-stop cylinders. The high pressure of the cylinder shall be overcome when the boom tilts backwards, and high pressure oil will be supplemented automatically when the boom swings forwards to increase the tension and prevent the boom vibration and shaking back.
- The jib rear mast is equipped with a pair of back-stop cylinders, while the jib front mast is equipped with a pair of pneumatic cylinders to prevent the mast from the backward inclination and tension of the jib luffing wire rope.

Brake of Hoisting Mechanism

- All hoisting brakes are spring loaded normally closed disc brakes, which are featured with large braking force, maintenance-free, safe and reliable use, and long service life.

CCTV Monitoring System

- It can be used to monitor the winding conditions of wire ropes of each hoisting mechanism, the conditions of superlift weight, and conditions around the equipment.

Fault Auto-Diagnosis System

- Faults can be conveniently eliminated based on the fault code.

Black Box

- It is able to record the operation data and machine movement, and analyze the remaining running conditions and service life of machine based on the actual performance.

Pharos

- It is mounted on the top of the boom/jib and alerts in air during night.

Anemometer

- It is mounted on the top of the boom/jib to monitor the wind speed in real time and display relative data on the monitor.

Safety Devices



Electronic Level Indicator

- It displays the tilting angle of the crane on the monitor in real time and protects the safe operation of the crane.

Lightning Protection Device

- It includes the lightning protection device and the surge protection device, which can effectively protect the electric system elements and workers from lightning.

Hook Latch

- The lifting hook is installed with a baffle plate to prevent wire rope from falling off.

Swing and Traveling Alarm

- During swing and traveling, the alarm horn will be blown per certain frequency to alert the personnel around the crane. The horn can be shut off through the display.

Seat interlock

- The operation will be locked by pulling up the function locking lever on the right side of the seat inside the driver's cab or when the operator left the seat, after which no operating handles will be working so that improper operation caused by the body collision when getting on and off the crane can be avoided.

Regulation of Engine Power Ultimate Load and Stalling Protection

- The controller can monitor the engine power so as to prevent stalling.

Engine Status Monitoring

- It can show the engine coolant temperature, fuel volume, total working hours, engine oil pressure, engine speed, battery and voltage.

Remote Monitoring System

- It monitors and analyzes the operation data so as to realize remote diagnosis of faults and timely solution.

Emergent Stop

- In a sudden loss of control, press the emergent stop, all actions such as hoisting, luffing, swinging and traveling brake and engine stops.



SCE4000A-1
SANY CRAWLER CRANE
400TONS LIFTING CAPACITY

QUALITY CHANGES THE WORLD

Technical Parameters

- Page 10 Major Performance & Specifications
- Page 11 Outline Dimension
- Page 13 Transport Dimensions
- Page 20 Transport Plan
- page 23 Self-Assembly Plan

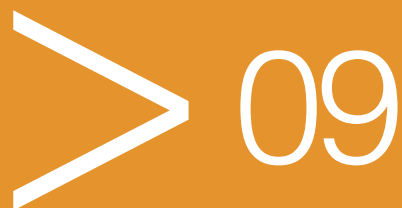

Major Performance & Specifications

Major Performance & Specifications of SCE4000A-1		
Performance Indicators	Unit	Parameter
Max. rated lifting capacity	t	400
Max. rated lifting moment	t·m	2695=385×7
Max. rated lifting moment (with superlift)	t·m	5328=333×16
Boom length (H)	m	24~84
Boom length (HDB with superlift)	m	36~84
Length of mixed boom (HJ)	m	45~99
Length of mixed boom (HJDB with superlift)	m	69~123
Length of luffing jib (LJ)	m	21~75
Length of luffing jib (LJDB with superlift)	m	21~81
Combination of longest boom+luffing jib (LJDB Configuration)	m	84+81
Heavy boom for wind energy	m	9
Boom + Fixed jib (FJh Configuration)	m	24+9
Boom+Fixed jib(FJhDB Configuration)	m	36+9
Boom + Mixed boom + Fixed jib (HJFJ Wind energy)	m	90+9
Angle of boom hoisting	°	30~85
Angle of jib luffing	°	15~75
Max. speed of single rope of the main load hoist	m/min	0~140
Max. speed of single rope of the aux. load hoist	m/min	0~140
Max. speed of single rope of the boom hoisting	m/min	(0~65)×2
Max. speed of single rope of the jib luffing	m/min	0~100
Max. speed of single rope of the superlift luffing	m/min	0~100
Slewing speed (no load)	r/min	0~1.4
Travel speed	km/h	0~1(high)/0~0.4(low)
Gradeability (with basic boom, driver's cab backwards)	%	15
Rated output power of the engine	kW/rpm	298/2100
Average ground pressure of the track (basic boom, 150t rear counterweight, 40t carbody weight, and 400t hook)	MPa	0.167
Max. transport dimension of single piece (L × W × H)	mm	12000×3000×3300
Max. transport weight of single piece	t	41.3

Unit: mm

Outline Dimension

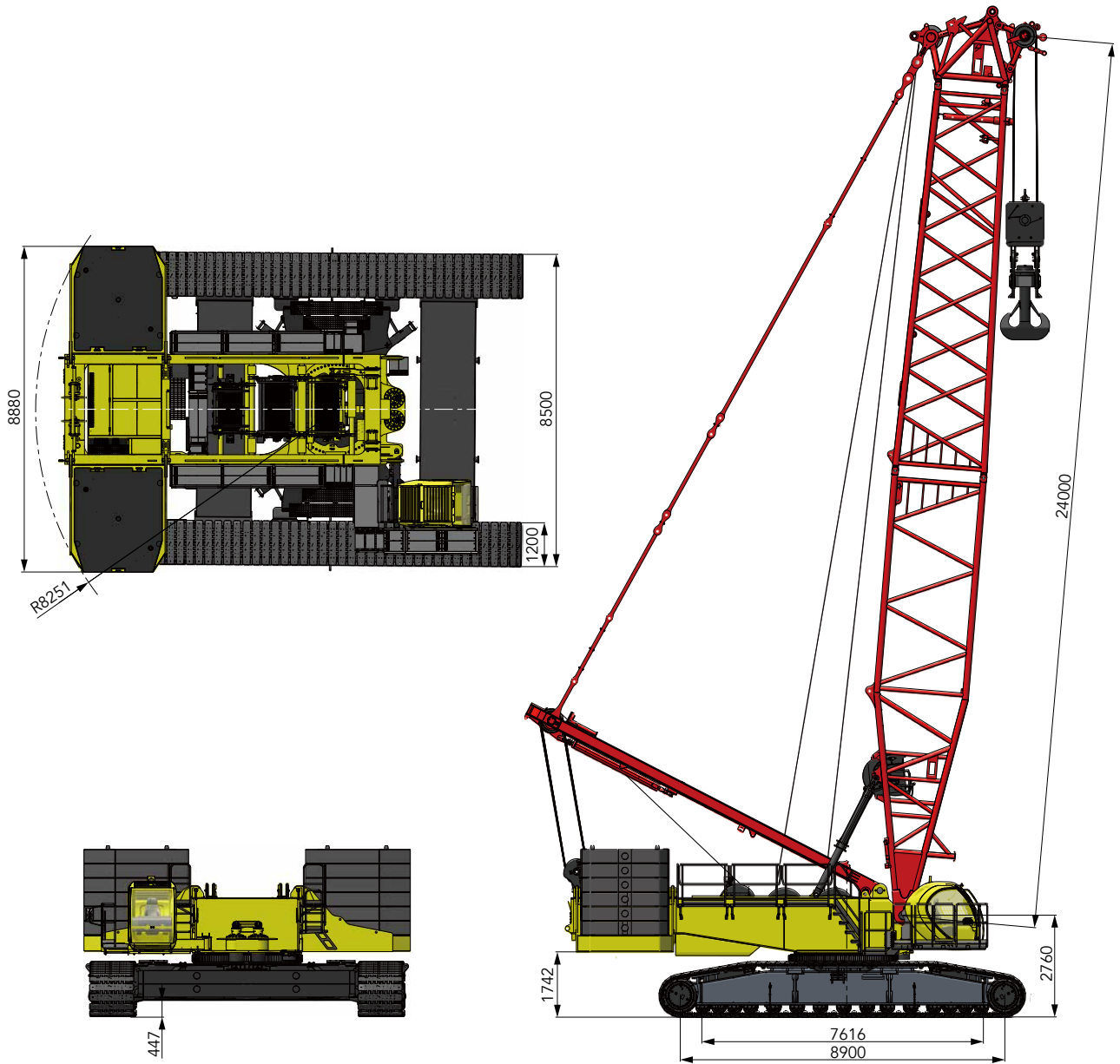

Outline Dimension

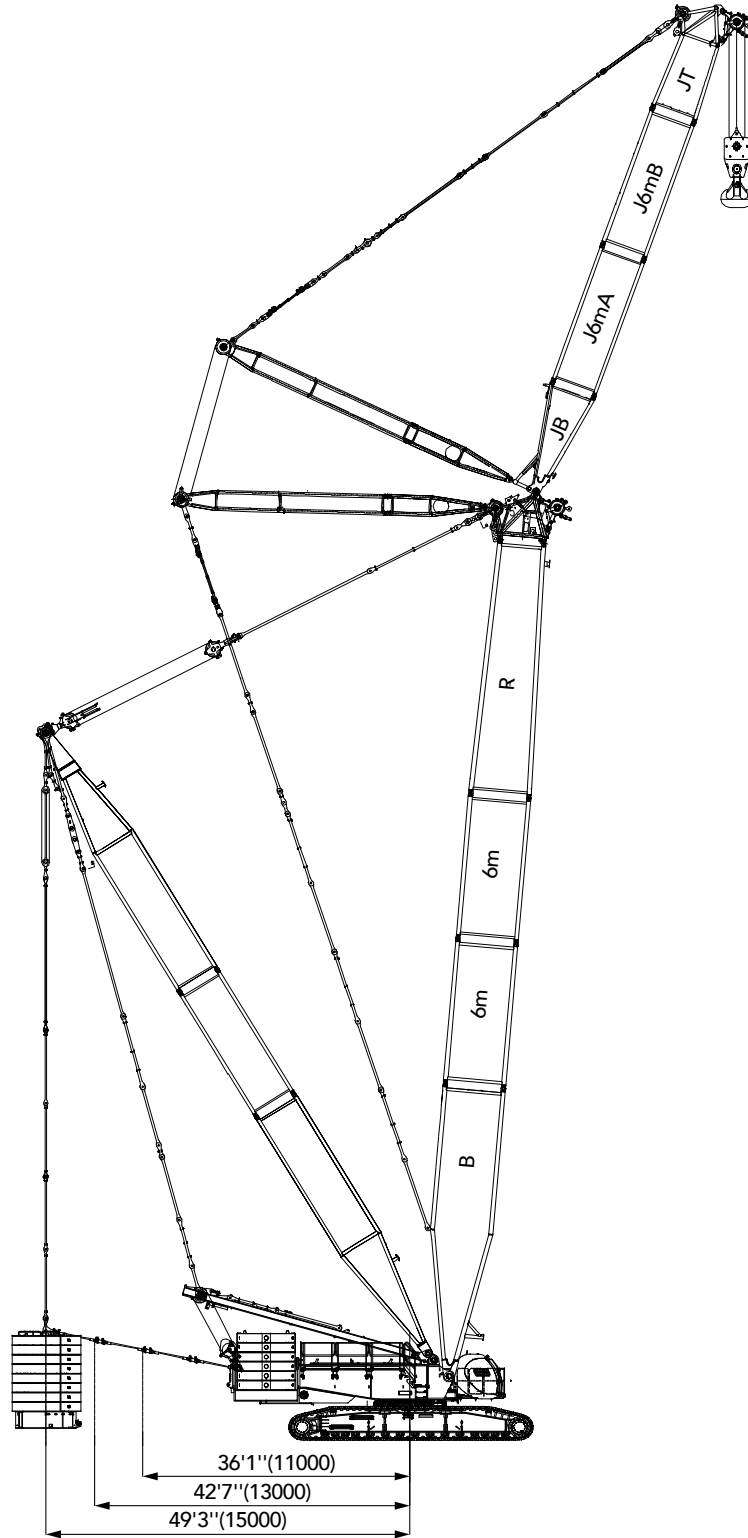

Transport Dimensions

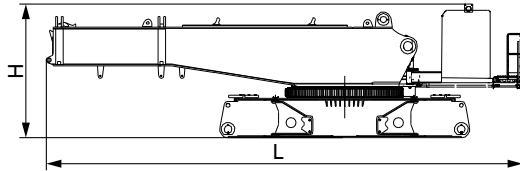

Basic machine	×1
Length(L)	12.00m
Width(W)	3.00m
Height(H)	3.30m
Weight	41.3

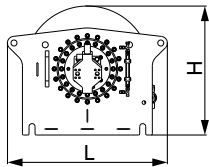

Hoist mechanism	×2
Length(L)	1.83m
Width(W)	1.32m
Height(H)	1.07m
Weight	5.5t

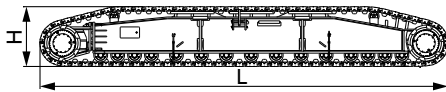

Crawler	×2
Length(L)	10.34m
Width(W)	1.20m
Height(H)	1.51m
Weight	29.5t

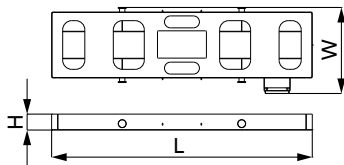

Upper carbody counterweight	×2
Length(L)	5.89m
Width(W)	1.94m
Height(H)	0.36m
Weight	10.0t

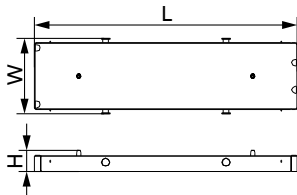

Lower carbody counterweight	×2
Length(L)	5.89m
Width(W)	1.70m
Height(H)	0.36m
Weight	10.0t

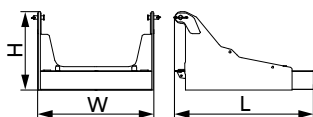

Rear counterweight tray	×2
Length(L)	3.20m
Width(W)	2.67m
Height(H)	1.80m
Weight	15.0t

Transport Dimensions

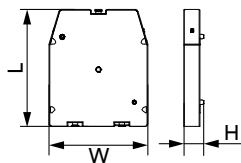

10t counterweight block ×32

Length(L)	2.85m
Width(W)	2.40m
Height(H)	0.49m
Weight	10.0t

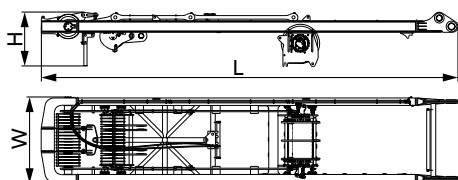

Boom hoist mast with winch ×1

Length(L)	10.88m
Width(W)	2.24m
Height(H)	1.41m
Weight	11.33t

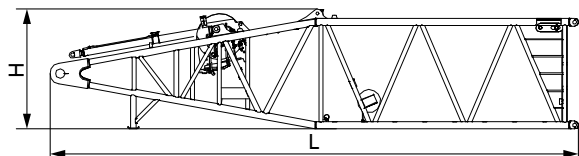

Boom base with jib luffing winch ×1

Length(L)	12.40m
Width(W)	3.00m
Height(H)	2.79m
Weight	13.02t

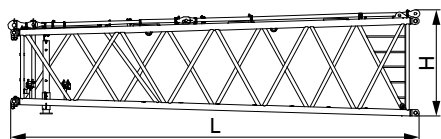

Tapered insert of boom ×1

Length(L)	10.68m
Width(W)	2.96m
Height(H)	2.79m
Weight	5.2t

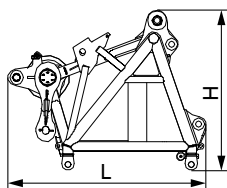

Boom tip ×1

Length(L)	2.34m
Width(W)	2.59m
Height(H)	2.60m
Weight	3.58t

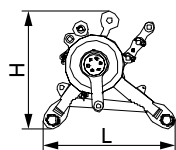

Sheave block ×2

Length(L)	1.42m
Width(W)	1.36m
Height(H)	1.27m
Weight	0.93t

Transport Dimensions

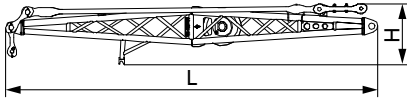

Fixed jib mast ×1	
Length(L)	6.20m
Width(W)	2.47m
Height(H)	1.10m
Weight	1.30t

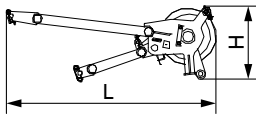

Extension jib ×1	
Length(L)	2.22m
Width(W)	1.00m
Height(H)	1.43m
Weight	0.36t

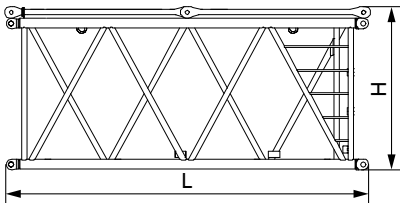

6m boom insert ×2	
Length(L)	6.24m
Width(W)	2.96m
Height(H)	2.78m
Weight	2.5t

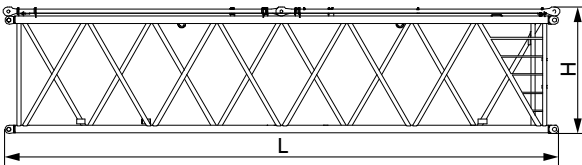

12m boom insert A ×1	
Length(L)	12.24m
Width(W)	2.96m
Height(H)	2.78m
Weight	4.6t

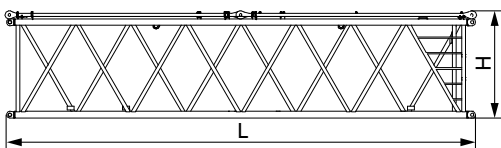

12m boom insert B ×3	
Length(L)	12.24m
Width(W)	2.96m
Height(H)	2.78m
Weight	4.0t

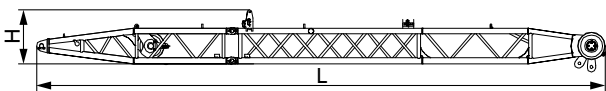

Front mast of luffing jib ×1	
Length(L)	13.44m
Width(W)	2.18m
Height(H)	1.48m
Weight	3.3t

Transport Dimensions

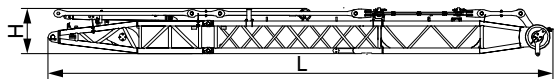

Rear mast of luffing jib		×1
Length(L)	12.94m	
Width(W)	2.94m	
Height(H)	1.29m	
Weight	5.1t	

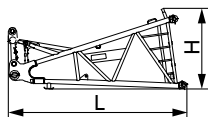

Luffing jib base		×1
Length(L)	4.74m	
Width(W)	2.56m	
Height(H)	2.30m	
Weight	2.4t	

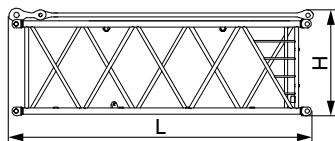

6m luffing jib insert I		×1
Length(L)	6.28m	
Width(W)	2.56m	
Height(H)	2.28m	
Weight	2.0t	

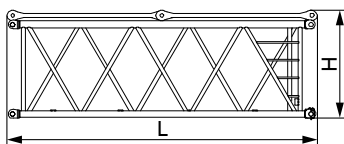

6m luffing jib insert II		×1
Length(L)	6.30m	
Width(W)	2.60m	
Height(H)	2.30m	
Weight	1.7t	

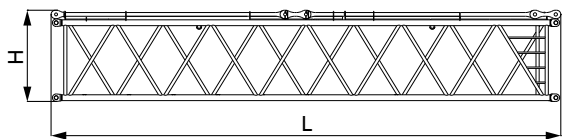

12m luffing jib insert A		×1
Length(L)	12.24m	
Width(W)	2.56m	
Height(H)	2.19m	
Weight	2.8t	

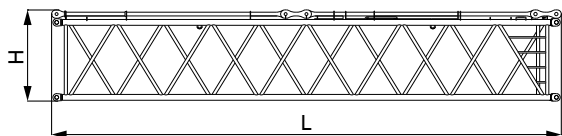

12m luffing jib insert B		×4
Length(L)	12.24m	
Width(W)	2.56m	
Height(H)	2.19m	
Weight	3.11t	

Transport Dimensions

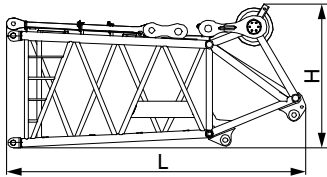

Luffing jib top	×1
Length(L)	5.05m
Width(W)	2.56m
Height(H)	2.43m
Weight	3.0t

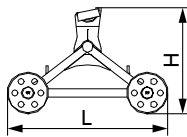

Trolley	×1
Length(L)	2.02m
Width(W)	1.23m
Height(H)	1.33m
Weight	0.6t

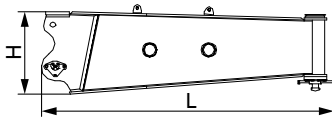

Side outrigger	×2
Length(L)	3.63m
Width(W)	0.78m
Height(H)	1.05m
Weight	1.9t

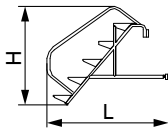

Ladder	×2
Length(L)	1.25m
Width(W)	0.56m
Height(H)	1.22m
Weight	0.05t

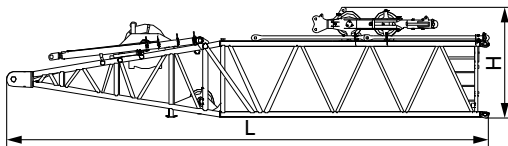

Superlift mast base	×1
Length(L)	12.28m
Width(W)	3.00m
Height(H)	2.86m
Weight	16.7t

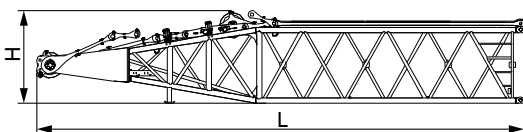

Superlift mast top	×1
Length(L)	12.42m
Width(W)	2.90m
Height(H)	2.40m
Weight	8.5t

Transport Dimensions

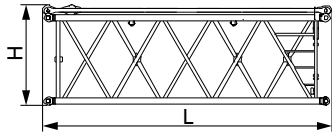

Superlift mast insert

×1

Length(L)	6.18m
Width(W)	2.90m
Height(H)	2.15m
Weight	2.5t

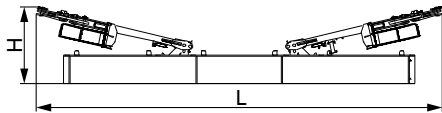

Superlift counterweight tray

×1

Length(L)	9.95m
Width(W)	2.70m
Height(H)	2.20m
Weight	9.0t

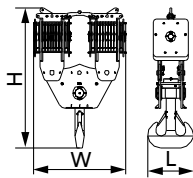

400t hook of dual sheave blocks

×1

Length(L)	1.02m
Width(W)	2.69m
Height(H)	4.07m
Weight	10.5t

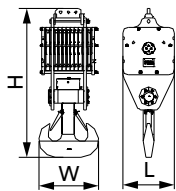

260t hook

×1

Length(L)	1.02m
Width(W)	1.13m
Height(H)	2.93m
Weight	4.8t

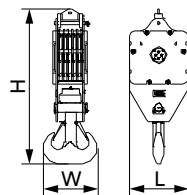

160t hook

×1

Length(L)	0.60m
Width(W)	1.02m
Height(H)	2.65m
Weight	3.1t

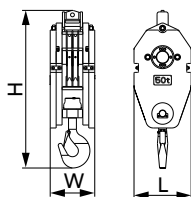

50t hook

×1

Length(L)	0.77m
Width(W)	0.60m
Height(H)	2.12m
Weight	2.4t

Transport Dimensions

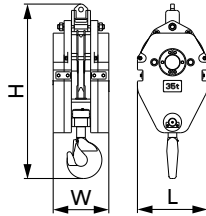

35t hook

×1

Length(L)	0.77m
Width(W)	0.61m
Height(H)	1.92m
Weight	2.25t

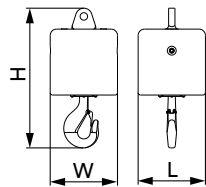

16t hook

×1

Length(L)	0.53m
Width(W)	0.53m
Height(H)	1.10m
Weight	0.9t

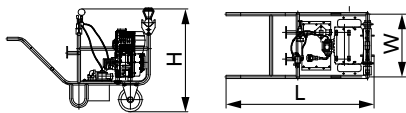

Portable hydraulic power pack system

×1

Length(L)	0.54m
Width(W)	0.23m
Height(H)	0.38m
Weight	0.19t

Note:

1. The transport dimensions of each part in the table are schematic, not proportional to the real parts. The dimensions are designed value without package considered.
2. Weight is designed value that the actual manufactured part may deviate a little.
3. The dimensions and weight of each part may change due to product upgrading. The final values are subject to the new product.

Transport Plan

Transport weight	▪ 41.3t
Part	▪ Basic machine×1
Truckload	▪ 1

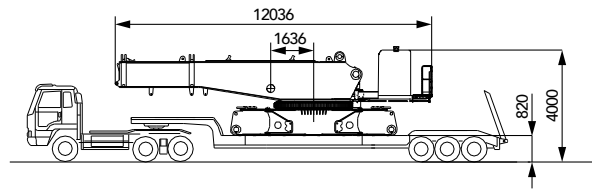

Transport weight	▪ 29.5t
Part	▪ Left track frame×1
Truckload	▪ 2

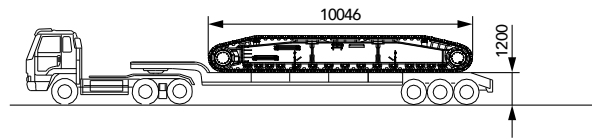

Transport weight	▪ 16.9t
Part	▪ Boom hoist mast×1 ▪ Main hoist winch×1 ▪ Boom hoist winch×1
Truckload	▪ 1

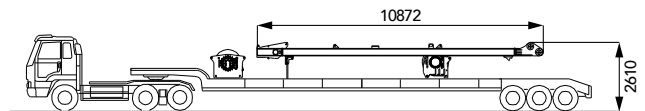

Transport weight	▪ 18.1t
Part	▪ 10t counterweight block×1 ▪ 12m boom insert A×1 ▪ 12m luffing jib insert B×1 ▪ Attachment parts×1
Truckload	▪ 1

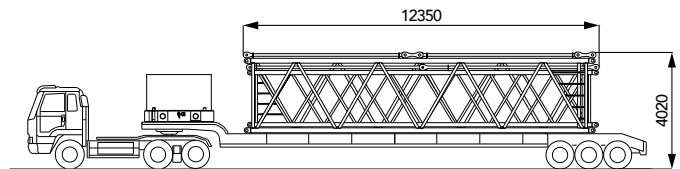

Transport weight	▪ 17.1t
Part	▪ 10t counterweight block×1 ▪ 12m boom insert B×1 ▪ 12m luffing jib insert B ×1 ▪ Attachment parts×1
Truckload	▪ 3

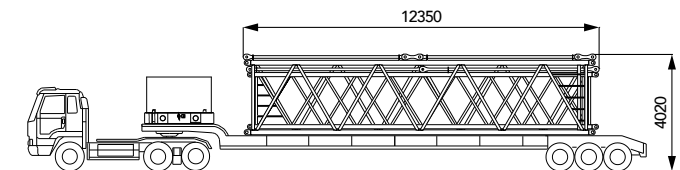

Transport weight	▪ 18.4t
Part	▪ 10t counterweight block×1 ▪ Front mast of luffing jib×1 ▪ Rear mast of luffing jib×1
Truckload	▪ 1

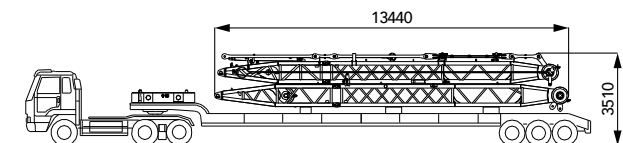

Transport weight	▪ 18.7t
Part	▪ Boom base×1 ▪ Jib luffing winch×1 ▪ 16t ball hook×1 ▪ 260t lifting hook×1
Truckload	▪ 1

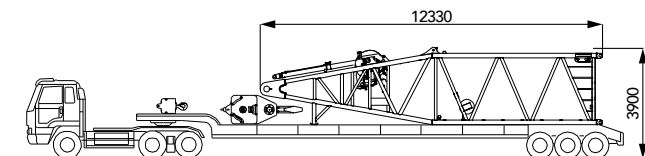

Transport Plan

Transport weight	▪ 18.7t
Part	▪ 6m luffing jib l×1 ▪ Rear counterweight tray×1 ▪ 50t hook×1
Truckload	▪ 1

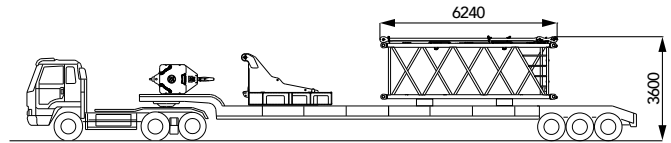

Transport weight	▪ 19.8t
Part	▪ 6m luffing jib ll×1 ▪ Rear counterweight tray×1 ▪ 160t hook×1
Truckload	▪ 1

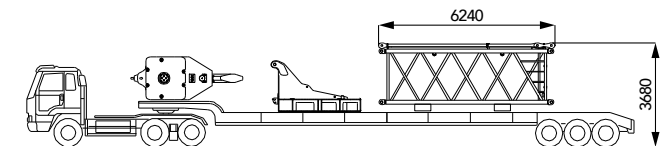

Transport weight	▪ 19.5t
Part	▪ Superlift counterweight tray×1 ▪ 400t hook of dual sheave blocks×1
Truckload	▪ 1

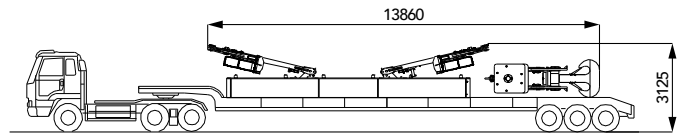

Transport weight	▪ 19.7t
Part	▪ 10t counterweight block×1 ▪ Tapered insert of boom×1 ▪ Boom tip×1 ▪ Sheave block×1
Truckload	▪ 1

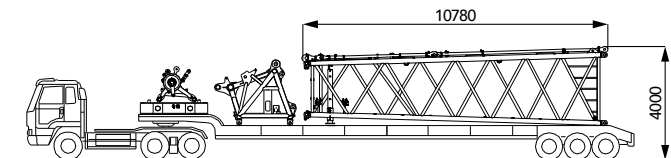

Transport weight	▪ 18t
Part	▪ Superlift mast base×1 ▪ Superlift luffing winch×1 ▪ Sheave block×1 ▪ Extension jib×1
Truckload	▪ 1

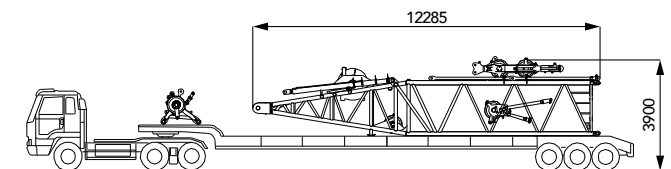

Transport weight	▪ 20.4t
Part	▪ Superlift mast boom top×1 ▪ 10t counterweight block×1 ▪ Side outrigger×1
Truckload	▪ 1

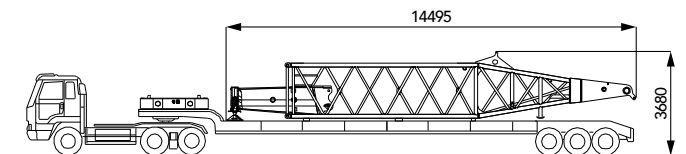

Transport weight	▪ 17.1t
Part	▪ 10t counterweight block×1 ▪ Superlift mast boom insert×1 ▪ 6m boom insert×1 ▪ Portable hydraulic power pack system×1 ▪ Side outrigger×1
Truckload	▪ 1

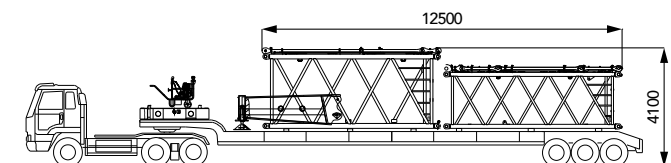

Transport Plan

Transport weight	▪ 20t
Part	▪ Upper carbody counterweight×1 ▪ Lower carbody counterweight×1
Truckload	▪ 2

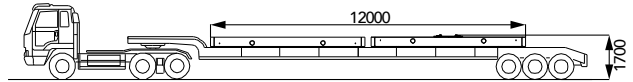

Transport weight	▪ 10.8t
Part	▪ 6m boom insert×1 ▪ Aux. hoist winch×1
Truckload	▪ 1

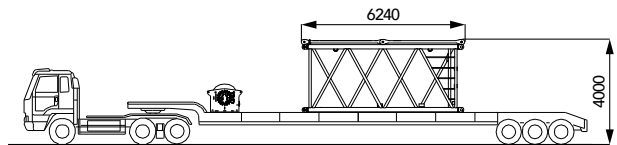

Transport weight	▪ 13.4t
Part	▪ 12m luffing jib insert A×1 ▪ 10t counterweight block×1 ▪ Trolley×1
Truckload	▪ 1

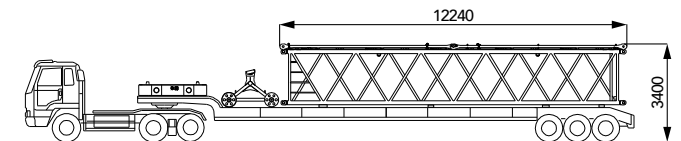

Transport weight	▪ 14.8t
Part	▪ Luffing jib base×1 ▪ Fixed jib mast×1 ▪ 10t counterweight×1
Truckload	▪ 1

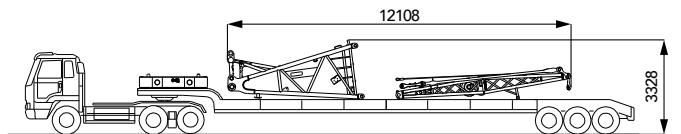

Transport weight	▪ 20t
Part	▪ 10t counterweight block×2
Truckload	▪ 11

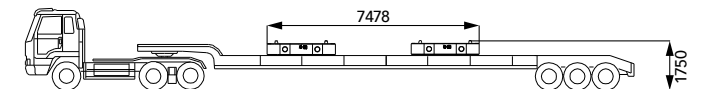

Note:
the transport combinations listed above is just some of the transport plans, for reference only;
Actual transport plan shall be determined by parts of Configurations as below, trailer, and transport regulation.

Self-Assembly Plan

Basic machine self-assembly

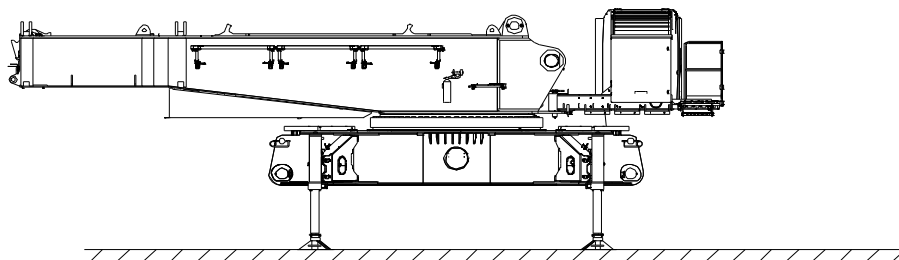
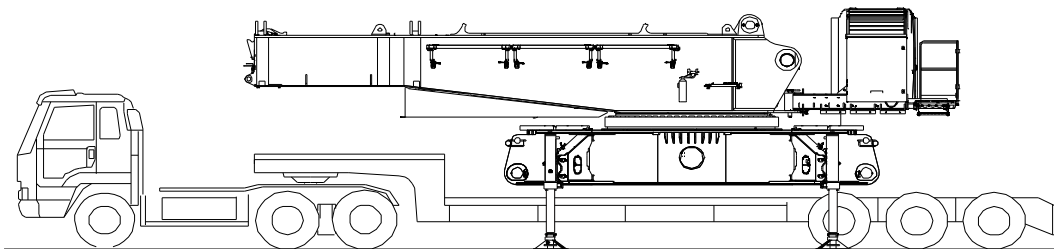
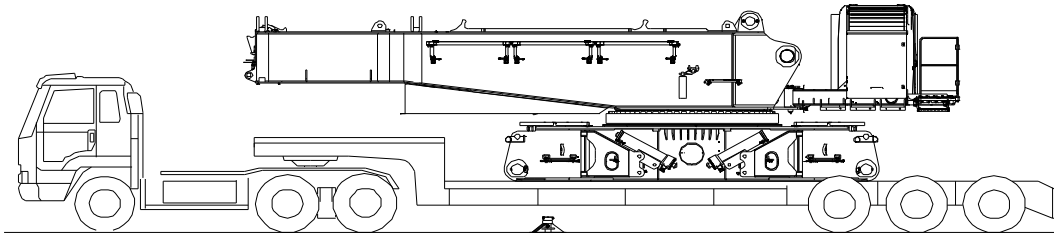

Note: The schematics above are reference for self-assembly method only.

Self-Assembly Plan

Crawler frame self-assembly

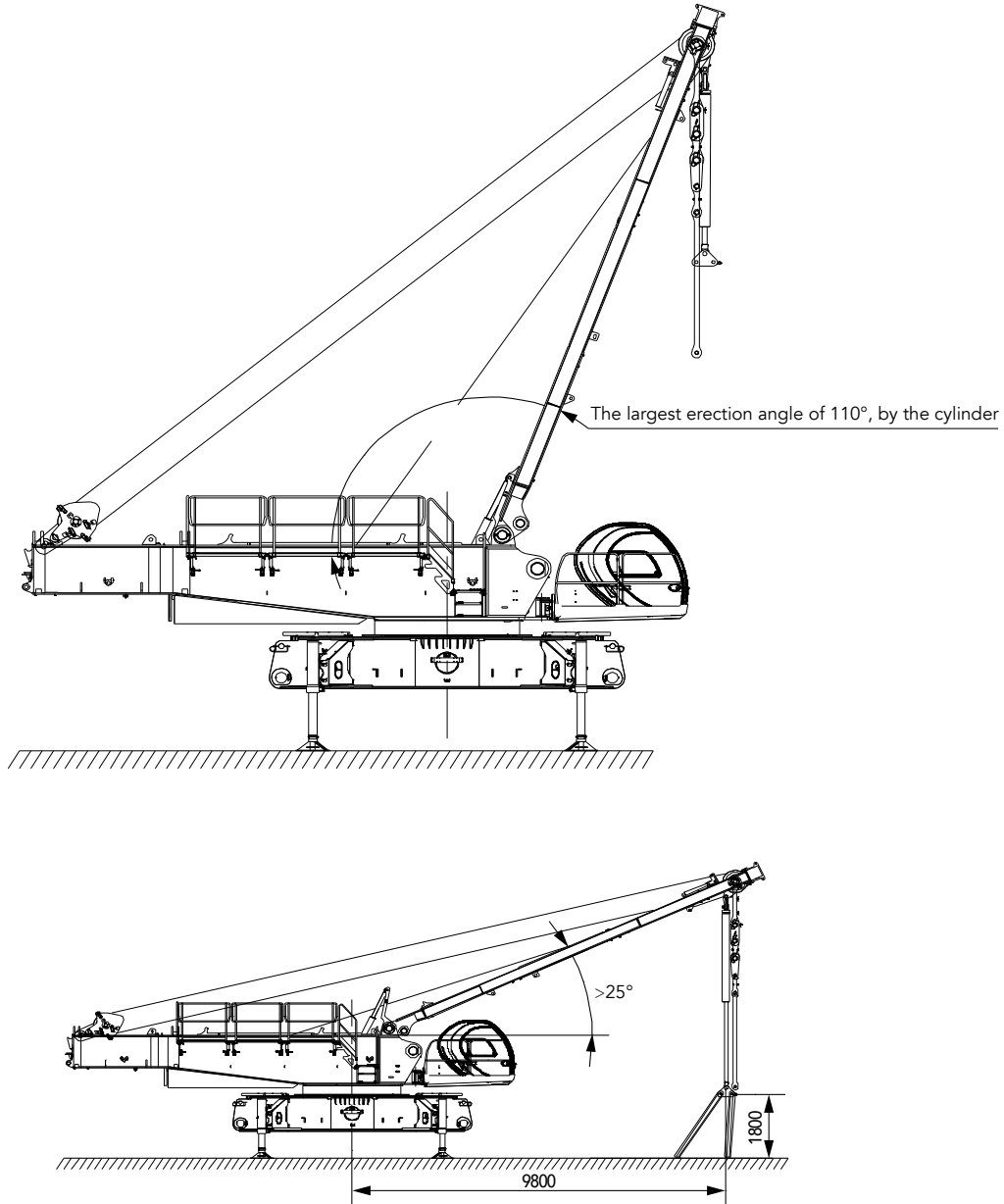

Note: The schematics above are reference for self-assembly method only.

Self-Assembly Plan

Crawler frame self-assembly

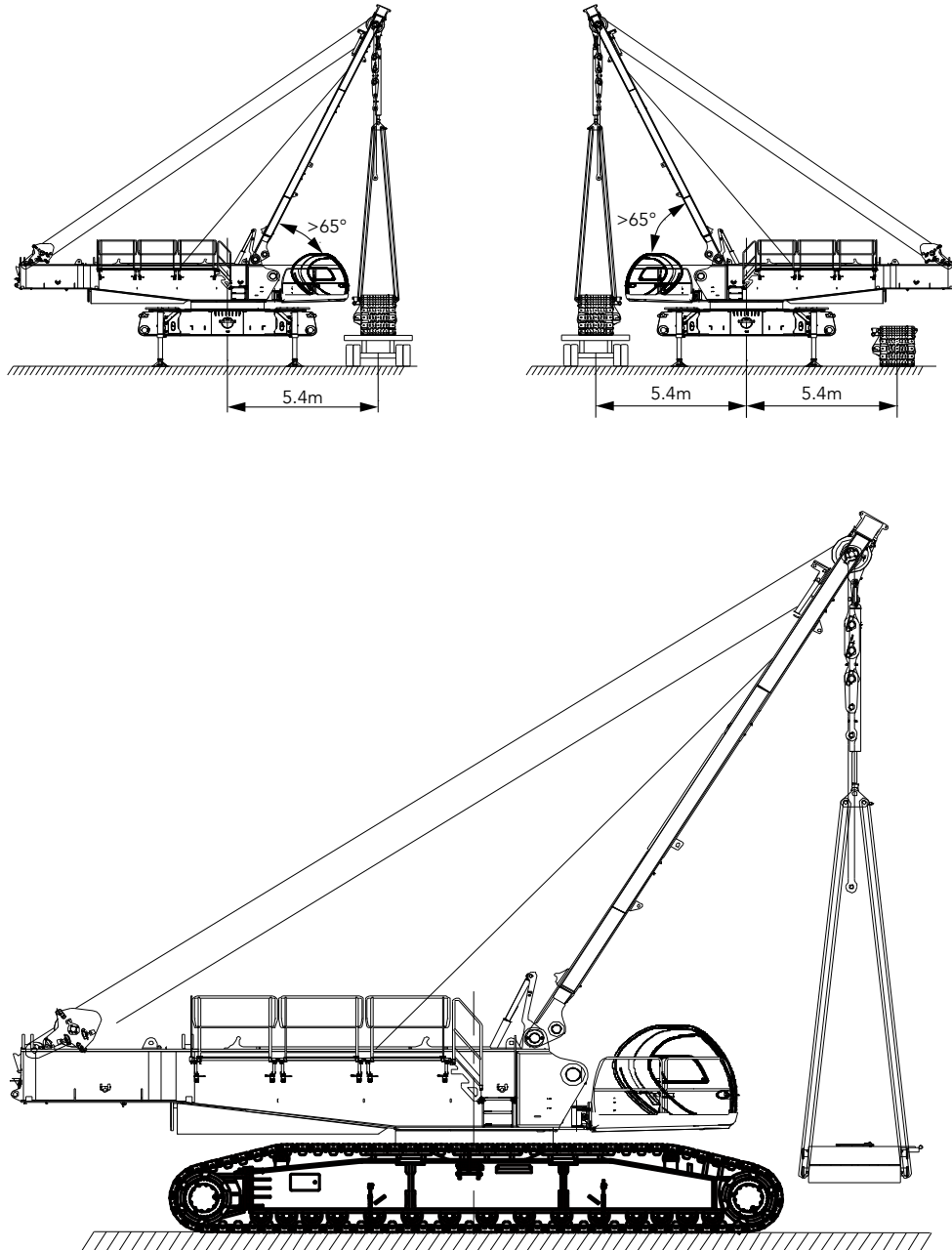

Note: The schematics above are reference for self-assembly method only.

Self-Assembly Plan

Boom assembly

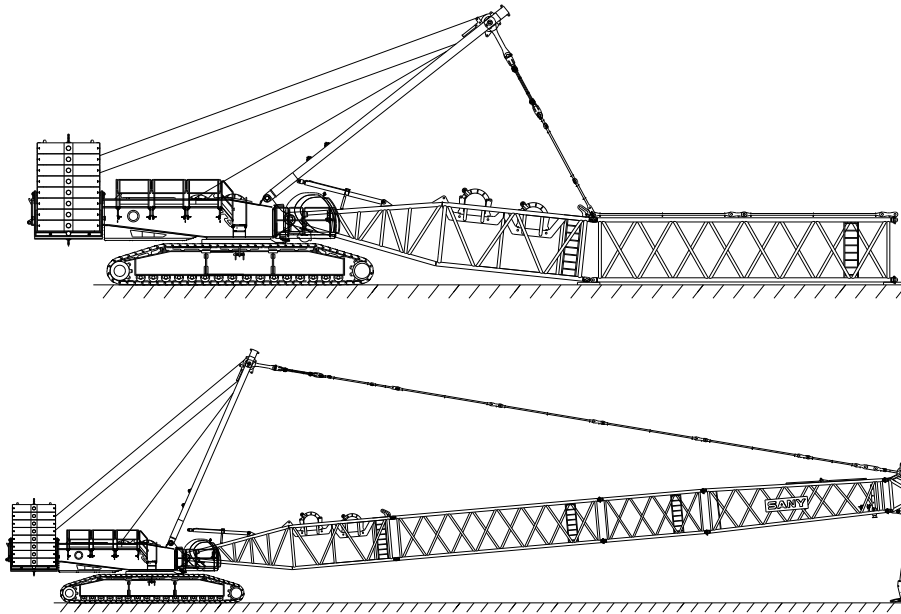

Superlift mast assembly

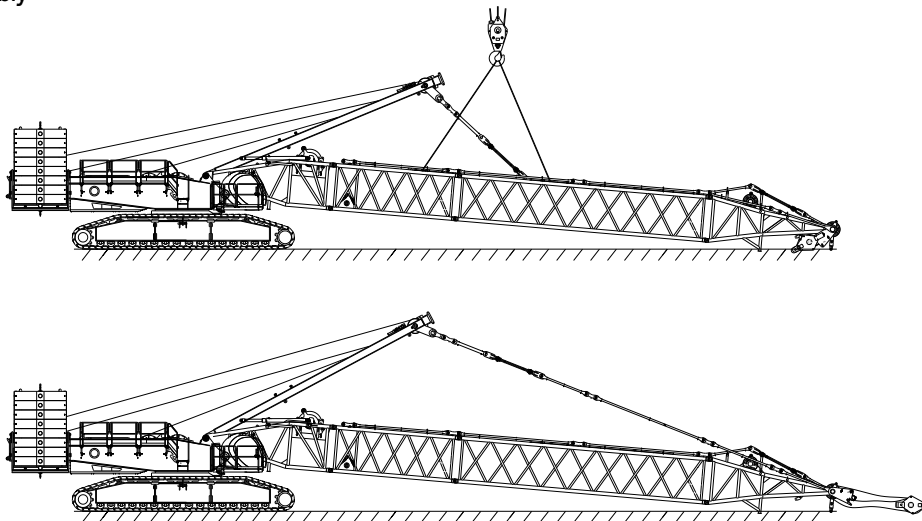

Note: The schematics above are reference for self-assembly method only.

Self-Assembly Plan

Luffing jib assembly

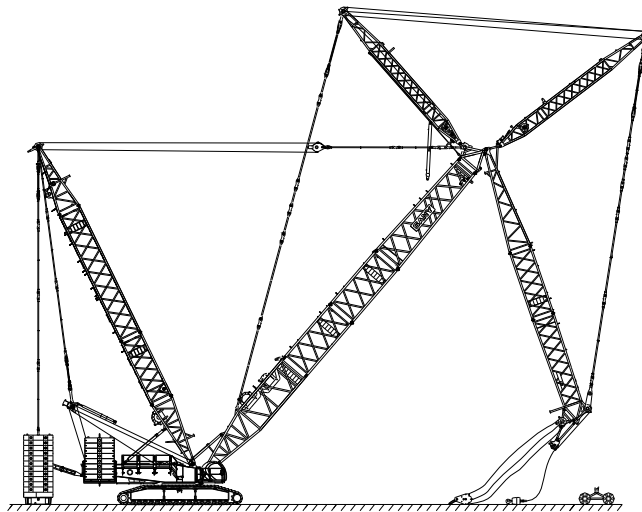
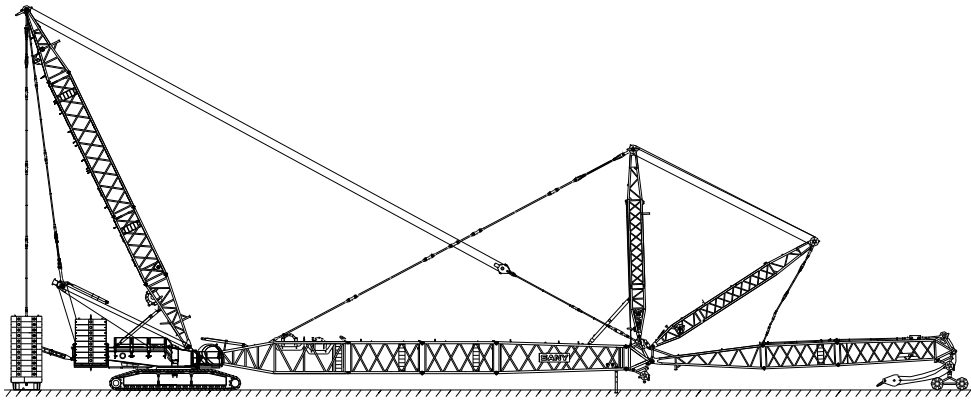

Note: The schematics above are reference for self-assembly method only.

Self-Assembly Plan

Fixed jib assembly

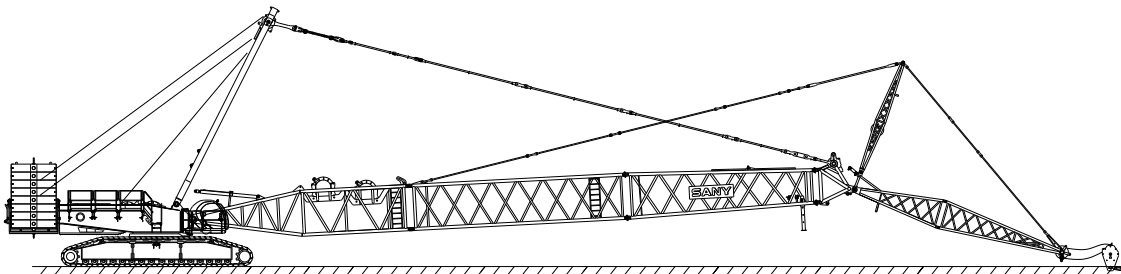
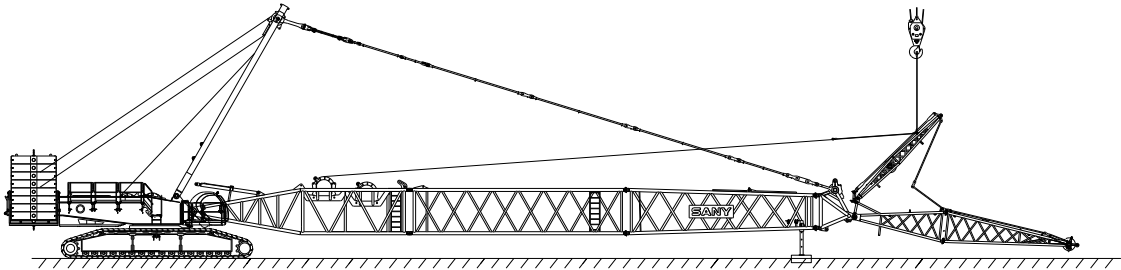
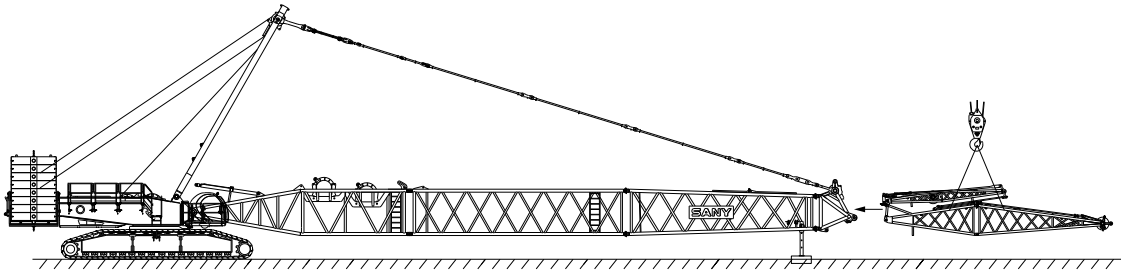

Note: The schematics above are reference for self-assembly method only.



SCE4000A-1
SANY CRAWLER CRANE
400TONS LIFTING CAPACITY

QUALITY CHANGES THE WORLD

Cofigurations

- Page 30 Configurations
- Page 33 H Configuration
- Page 36 HDB Configuration
- Page 40 HJ Configuration
- Page 43 HJDB Configuration
- Page 47 HJFJ Configuration
- Page 50 FJh Configuration
- Page 53 FJhDB Configuration
- Page 56 LJ Configuration
- Page 64 LJDB Configuration

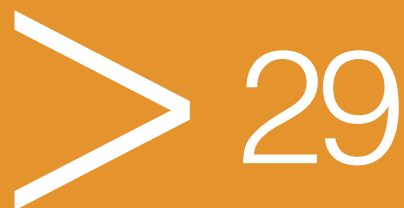

Boom combination

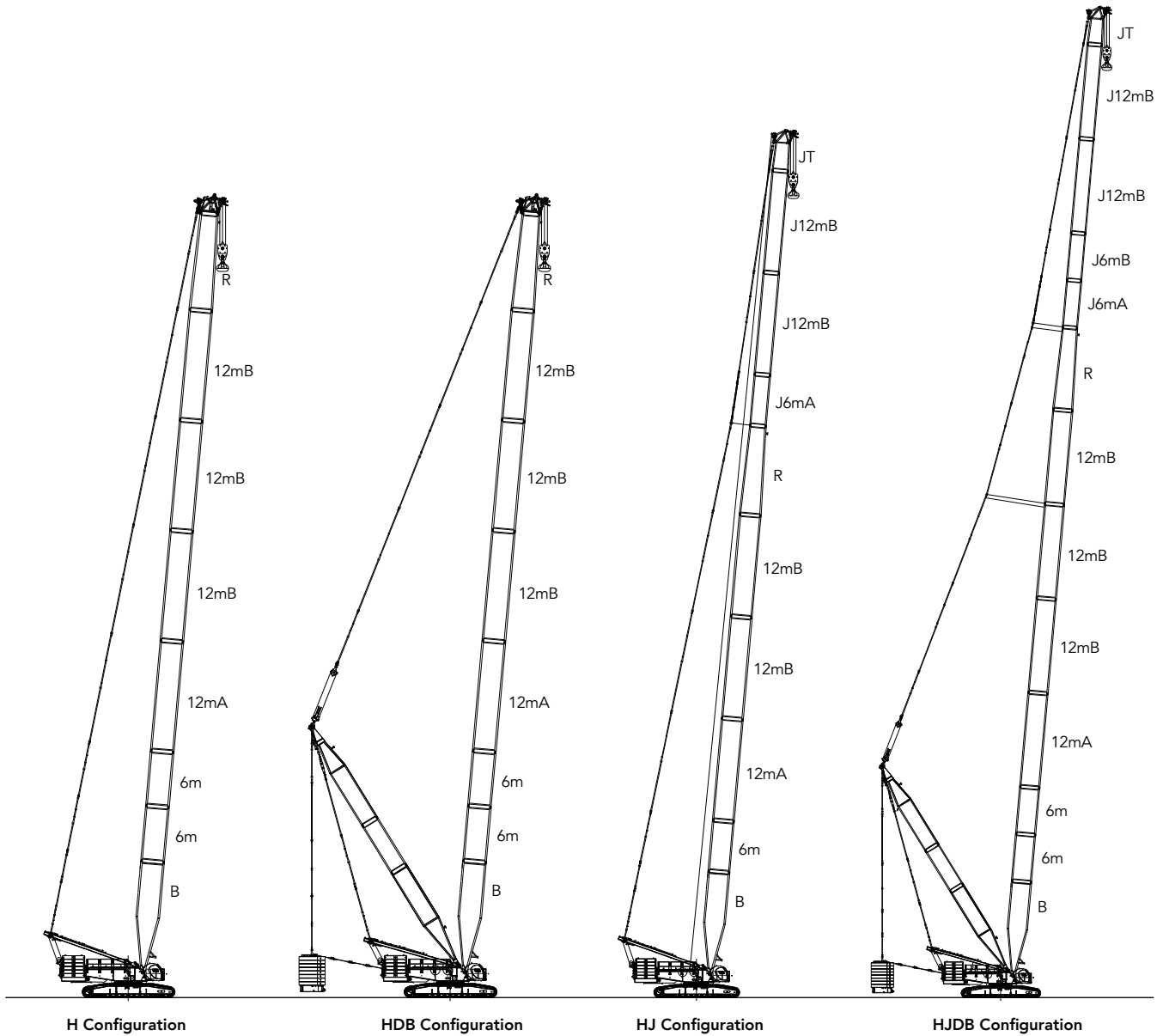

Configuration	Boom Combination	Boom Length
H	Boom	24m~84m
HDB	Boom+ superlift mast+ superlift counterweight	36m~84m
HJ	Mixed boom	45m~99m
HJDB	Mixed boom+ superlift mast+ superlift counterweight	69m~123m

Note: The schematics above are reference for loading only.

Boom combination

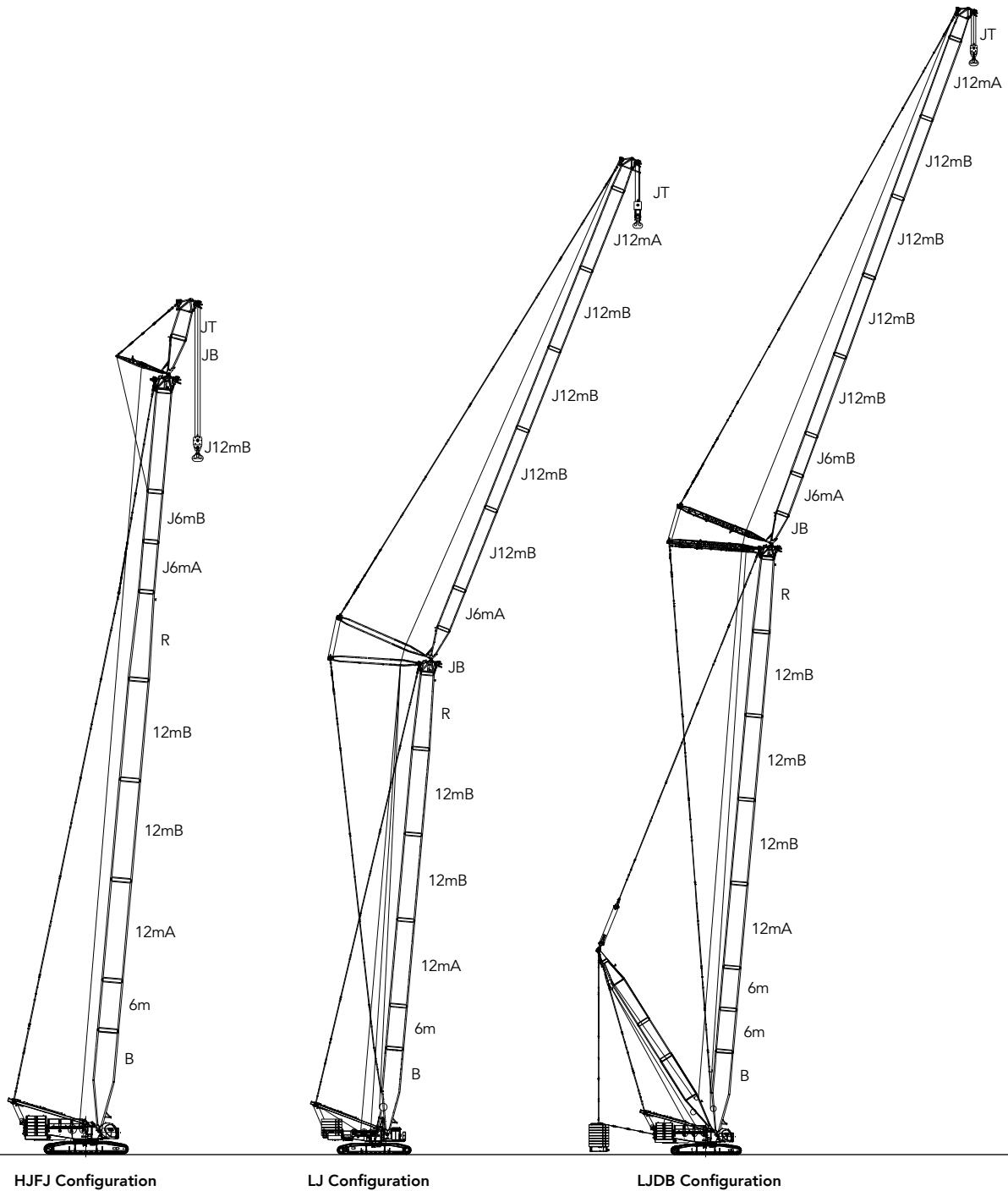

Configuration	Boom Combination	Boom Length
HJFJ	Mixed boom+ fixed jib	(72m~90m)+9m
LJ	Boom+luffing jib	(36m~66m)+(21m~75m)
LJDB	Boom + luffing jib +superlift mast+ superlift counterweight	(36m~84m)+(21m~81m)

Note: The schematics above are reference for loading only.

Boom combination

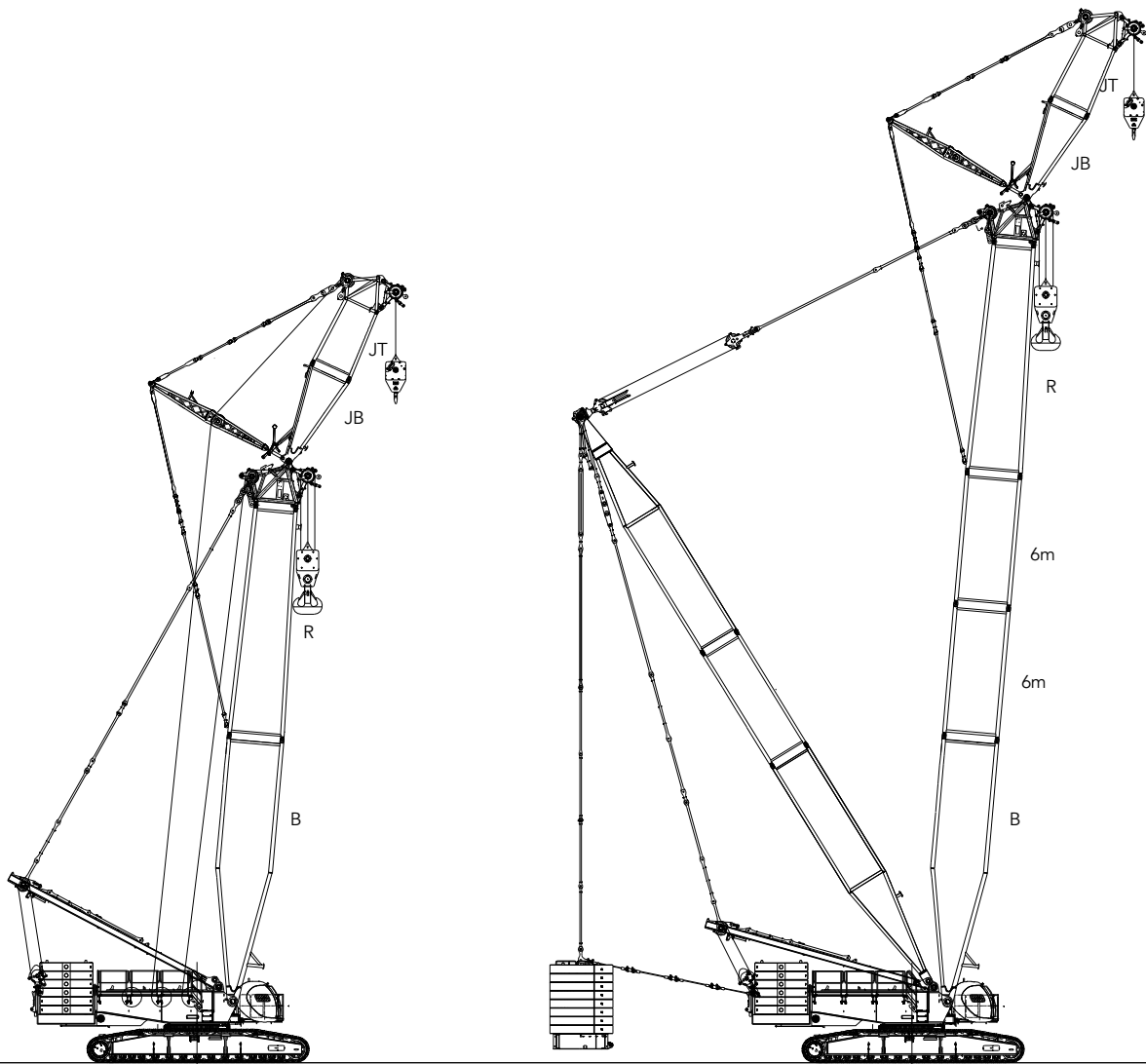

FJh Configuration

FJhDB Configuration

Configuration	Boom Combination	Boom Length
FJh	Boom+short heavy fixed jib	24m+9m
FJhDB	Boom+short heavy fixed jib + superlift mast+ superlift counterweight	36m+9m

Note: The schematics above are reference for loading only.

Boom Combination in H

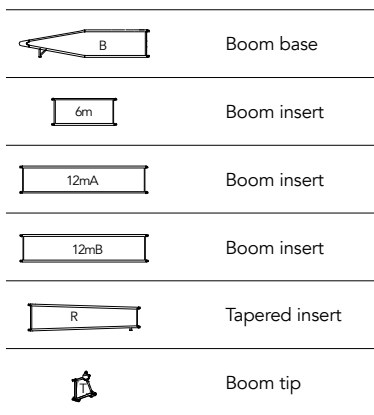
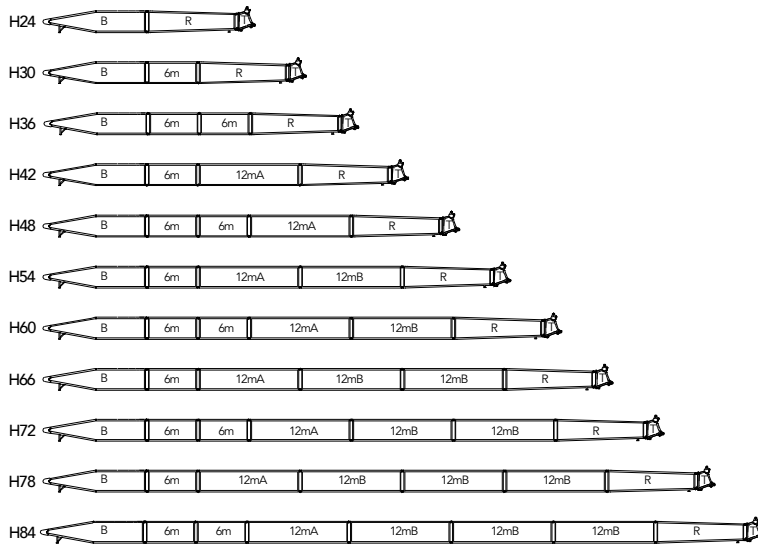

Note: The 24m basic boom consists of 12m boom base, 10.5m tapered insert and 1.5m boom tip.

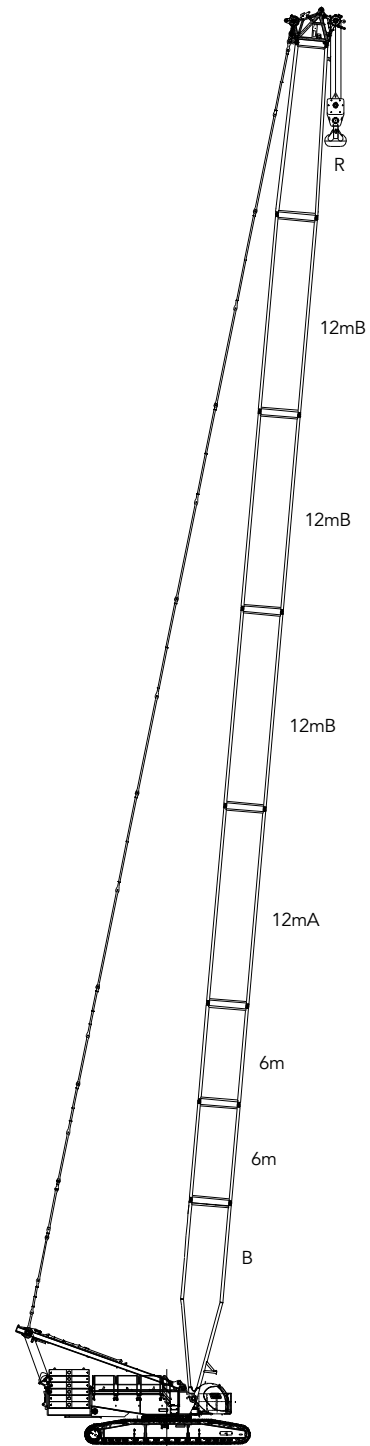

**H Configuration
(24m~84m)**

Working Radius in H

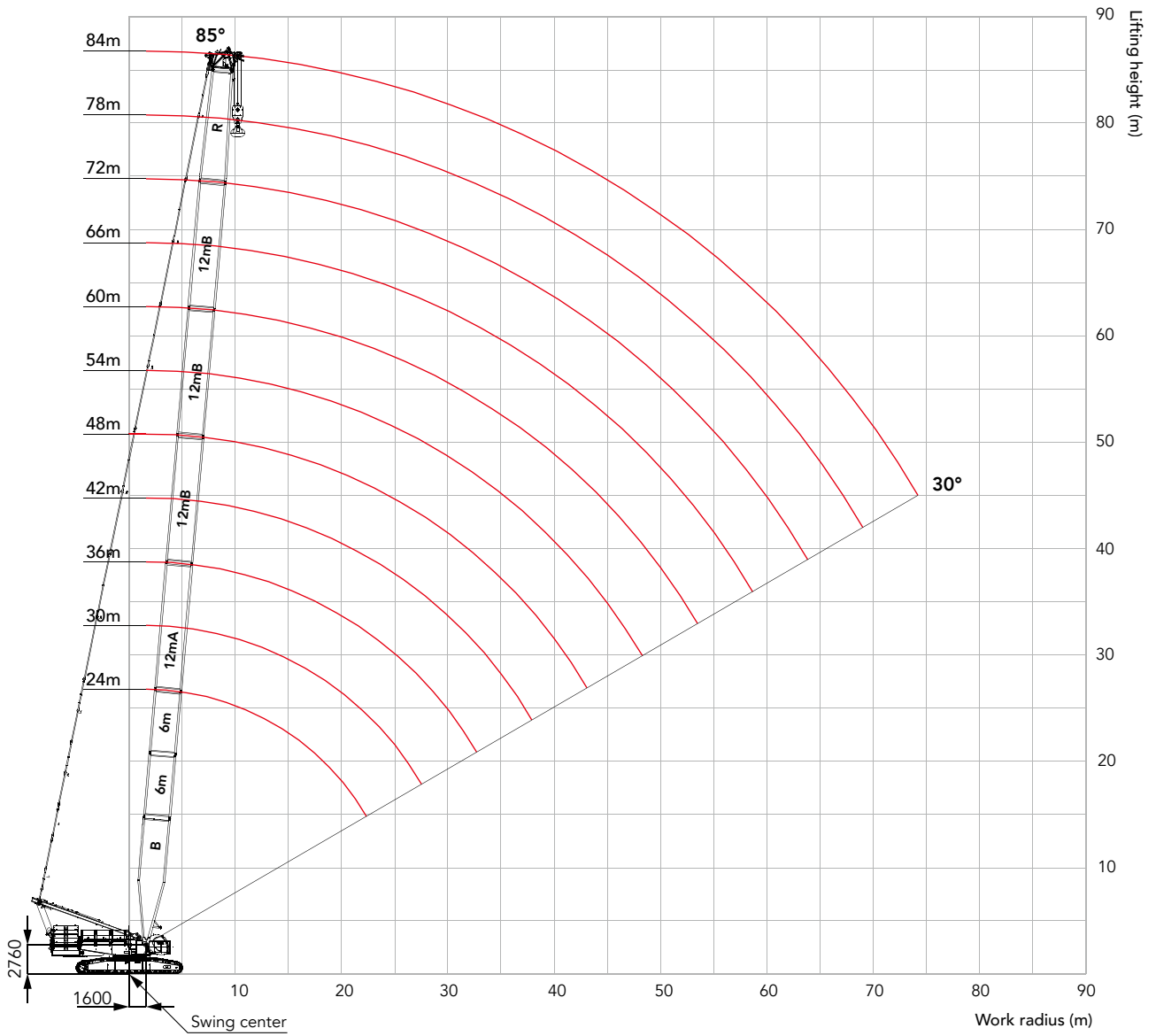

Unit:t

Load Chart of H

Note:

- 1.The rated load in the load chart is calculated complying with EN13000;
- 2.The working radius is the horizontal distance from the load center to the swing center;
- 3.The actual lifting capacity must subtract the weight of hooks and other riggings from the rated capacity in the load chart;
- 4.The load value is calculated when the object is hung freely,without considering the influence of wind on the load, ground conditions and slope, operation speed and the influence of any other negative factors over safe operation. Therefore, the operator bears the responsibility of making a judgment and decreasing the load and lowering speed;
- 5.All ratings are calculated when the machine is parking on firm and level ground with less than 1% gradient.

Load chart-H												
Boom length 24-84m,Rear counterweight 150t,Carbody counterweight 40t												
Radius (m)	24	30	36	42	48	54	60	66	72	78	84	Radius (m)
5.5	400											5.5
6	400	400										6
7	385	378	350	325								7
8	331	318	297	279	263	248						8
9	290	274	258	244	231	219	208	198				9
10	254	240	228	216	205	196	187	178	171	163		10
11	225	214	203	194	185	177	169	162	155	149	143	11
12	201	192	183	175	168	161	154	148	142	137	131	12
14	159	159	153	147	141	136	131	126	121	117	112	14
16	131	131	131	126	121	117	113	109	105	101	98.2	16
18	111	111	110	110	106	102	99.1	95.9	92.5	89.5	86.3	18
20	95.6	95.7	95.3	95	93.8	90.9	87.8	85	82.1	79.4	76.6	20
22	83.5	83.7	83.3	83	82.3	81.2	78.4	76	73.4	71.1	68.5	22
24		74	73.7	73.3	72.7	72.4	70.6	68.5	66.1	64	61.7	24
26		66	65.7	65.4	64.7	64.4	63.7	62	59.8	57.9	55.8	26
28		59.3	59.1	58.8	58.1	57.8	57.1	56.5	54.4	52.7	50.6	28
30			53.4	53.1	52.5	52.2	51.4	51	49.7	48.1	46.1	30
32			48.5	48.3	47.6	47.3	46.6	46.1	45.4	44	42.2	32
34				44.1	43.4	43.1	42.4	41.9	41.1	40.4	38.7	34
36				40.3	39.7	39.5	38.7	38.2	37.4	36.9	35.5	36
38				37	36.5	36.2	35.4	35	34.2	33.6	32.6	38
40					33.5	33.3	32.5	32.1	31.3	30.7	29.9	40
44						28.3	27.6	27.1	26.3	25.7	24.9	44
48						24.2	23.5	23	22.2	21.7	20.8	48
52							20	19.6	18.8	18.3	17.4	52
56								16.7	15.9	15.4	14.5	56
60									13.4	12.9	12	60
64									11.2	10.7	9.8	64
68										8.8	7.9	68
72											6.2	72

Boom Combination in HDB

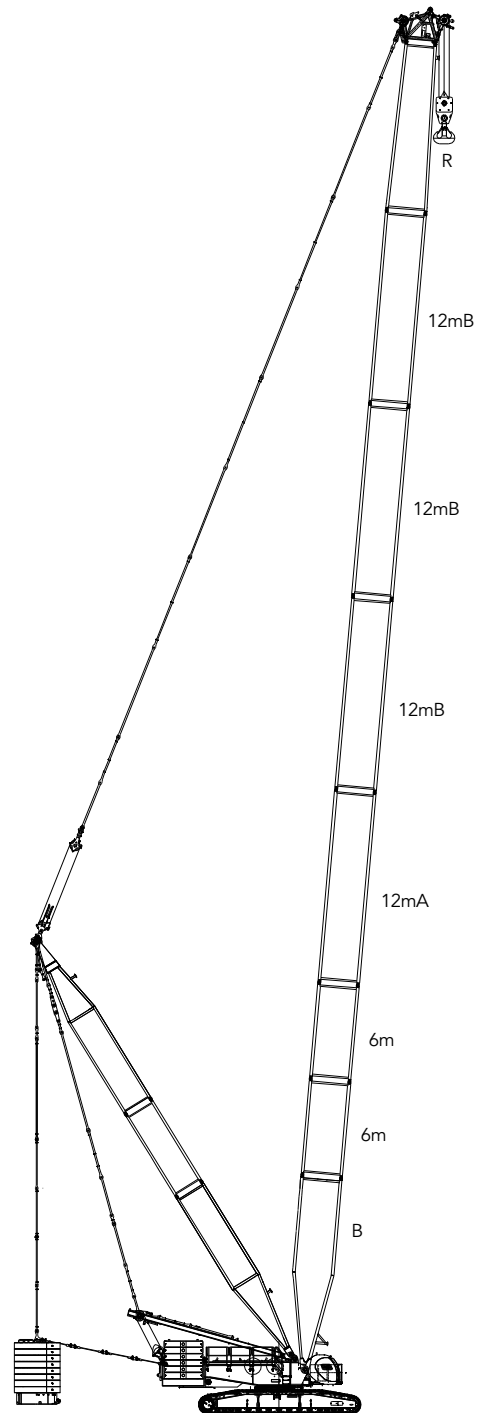
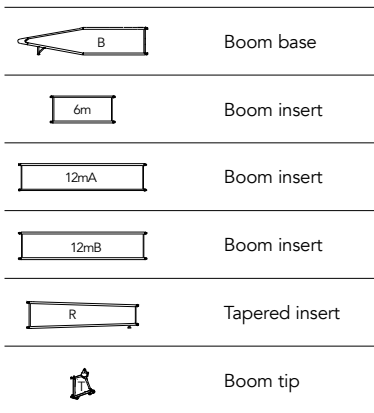
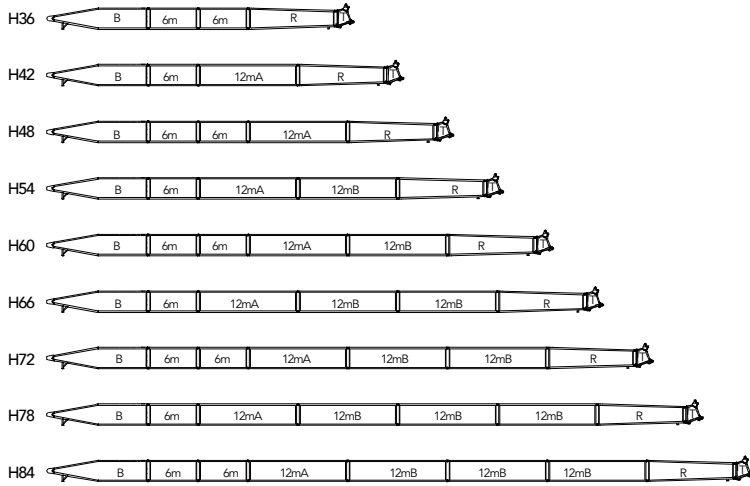

HDB Configuration
(36m~84m)

Working Radius in HDB

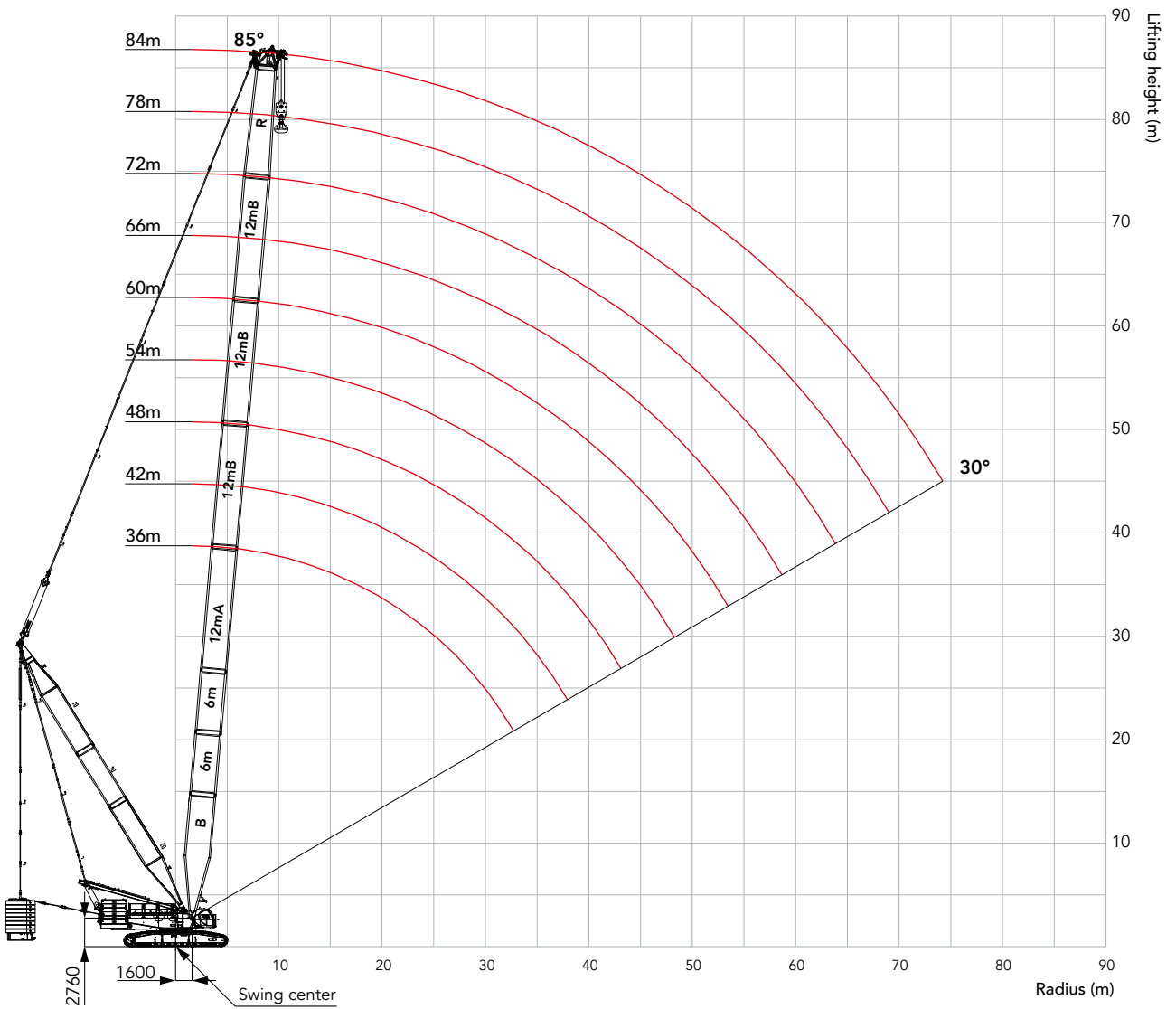

Load Chart of HDB

Note:

- 1.The rated load in the load chart is calculated complying with EN13000;
- 2.The working radius is the horizontal distance from the load center to the swing center;
- 3.The actual lifting capacity must subtract the weight of hooks and other riggings from the rated capacity in the load chart;
- 4.The load value is calculated when the object is hung freely,without considering the influence of wind on the load, ground conditions and slope, operation speed and the influence of any other negative factors over safe operation. Therefore, the operator bears the responsibility of making a judgment and decreasing the load and lowering speed;
- 5.All ratings are calculated when the machine is parking on firm and level ground with less than 1% gradient;
- 6.See the Operation Manual for the complete load charts of HDB Configurations.

Load chart-HDB

Boom length 36-84m,Superlift radius 15m,Superlift counterweight 0t, Rear counterweight 150t,Carbody counterweight 40t										
Radius(m)	36	42	48	54	60	66	72	78	84	Radius(m)
7	287	286								7
8	240	238	240	242						8
9	206	204	205	207	207	207				9
10	180	178	179	180	180	181	180	180		10
11	159	157	158	159	159	159	159	159	158	11
12	142	141	141	142	142	142	142	142	141	12
14	117	115	116	116	116	116	116	116	115	14
16	113	97.7	97.8	98.3	98.1	98	97.4	97.1	96.4	16
18	98	96.8	83.9	84.3	84	83.8	83.2	82.8	82.1	18
20	85.6	84.4	84.5	73.3	72.9	72.7	72	71.6	70.8	20
22	85.2	74.5	74.4	74.8	64	63.8	63	62.6	61.8	22
24	75.8	75.1	66.1	66.5	66.1	56.4	55.7	55.2	54.4	24
26	68	67.3	59.2	59.5	59.1	59	49.5	49	48.2	26
28	61.3	60.7	60.7	53.6	53.2	53	52.3	43.8	42.9	28
30	55.5	55	55	55.4	48	47.8	47.1	46.7	38.4	30
32	50.5	50	50	50.5	43.5	43.3	42.6	42.2	41.4	32
34		45.6	45.5	46	45.7	39.4	38.7	38.3	37.5	34
36		41.6	41.6	42.1	41.7	41.7	35.2	34.8	34	36
38		38.1	38.1	38.6	38.2	38.2	32.1	31.7	30.9	38
40			34.9	35.4	35.1	35	34.4	28.9	28.1	40
44				29.9	29.6	29.5	29	28.7	23.2	44
48				25.3	25	25	24.4	24.1	23.4	48
52					21.1	21.1	20.6	20.3	19.6	52
56						17.8	17.2	17	16.3	56
60							14.3	14.1	13.4	60
64							11.7	11.5	10.9	64
68								9.2	8.6	68
72									6.6	72

Unit:t

Load Chart of HDB

Load chart-HDB										
Boom length 36-84m,Superlift radius 15m,Superlift counterweight 150t, Rear counterweight 150t,Carbody counterweight 40t										
Radius(m)	36	42	48	54	60	66	72	78	84	Radius(m)
7	400*	400*								7
8	400	400	400	348*						8
9	400	400	400	349	329	279*				9
10	400	400	400	349	329	279	245*	203*		10
11	400	400	400	349	329	279	246	203*	176*	11
12	386	385	385	349	329	279	246	203*	176*	12
14	321	320	320	321	321	279	247	204	176	14
16	285	273	274	274	274	274	246	204	177	16
18	250	249	238	239	238	238	238	203	176	18
20	222	221	221	211	210	210	210	203	176	20
22	200	198	198	199	188	188	187	187	175	22
24	181	180	179	179	179	169	169	168	167	24
26	165	165	163	163	163	163	153	153	152	26
28	152	151	151	149	149	149	148	140	139	28
30	140	140	139	140	137	137	136	136	127	30
32	130	129	129	130	127	126	126	125	125	32
34		120	120	121	120	117	117	116	115	34
36		113	112	113	112	112	109	108	107	36
38		105	105	106	105	105	101	101	100	38
40			99.4	99.6	99.3	99.2	98.6	95	94.2	40
44				88.6	88.2	88.1	87.6	87.3	83.1	44
48				79.1	78.9	78.9	78.4	78.1	77.4	48
52					70.5	70.6	70.1	69.9	69.4	52
56						63.5	63.1	62.9	62.3	56
60							57	56.8	56.2	60
64							51.7	51.5	51	64
68								46.9	46.3	68
72									42.2	72

Note:For values marked with "**", the superlift counterweight shall not leave the ground.

Boom Combination of HJ

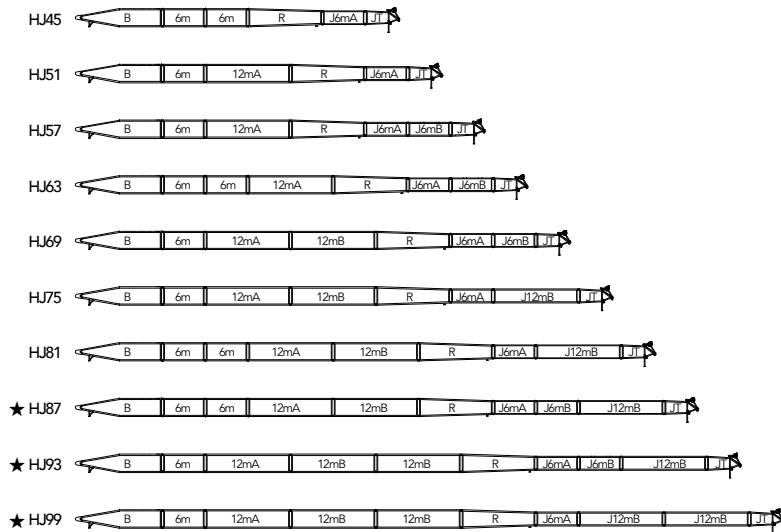

	Boom base
	Boom insert
	Boom insert
	Boom insert
	Tapered insert
	Boom tip
	Jib base
	Jib top
	Jib insert
	Jib insert
	Jib insert

Note:
 1. The 12m boom base, 10.5m tapered insert, 6m tapered jib insert, 4.5m jib top are must.
 2. For combinations marked with " ★ ", the mid-point suspension cable must be used, otherwise, the boom may break.

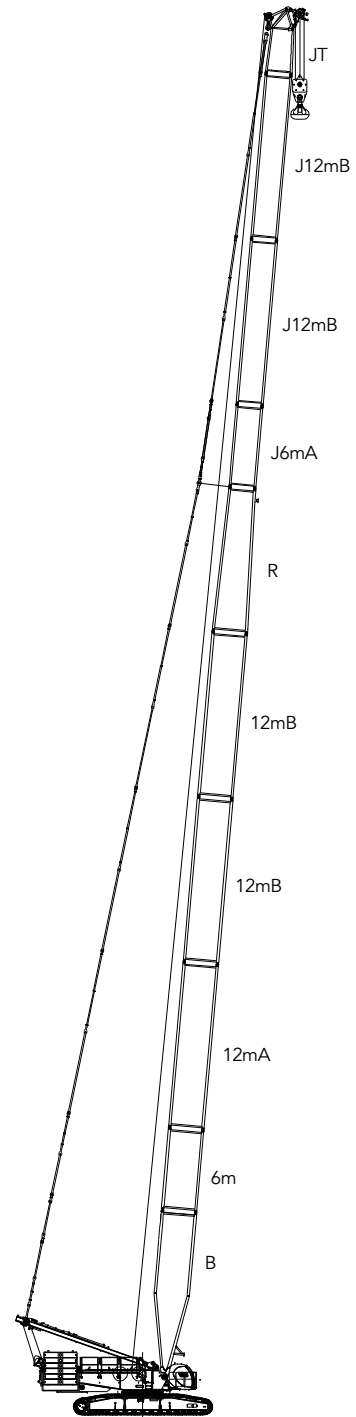

HJ Configuration
(45m~99m)

Working Radius in HJ

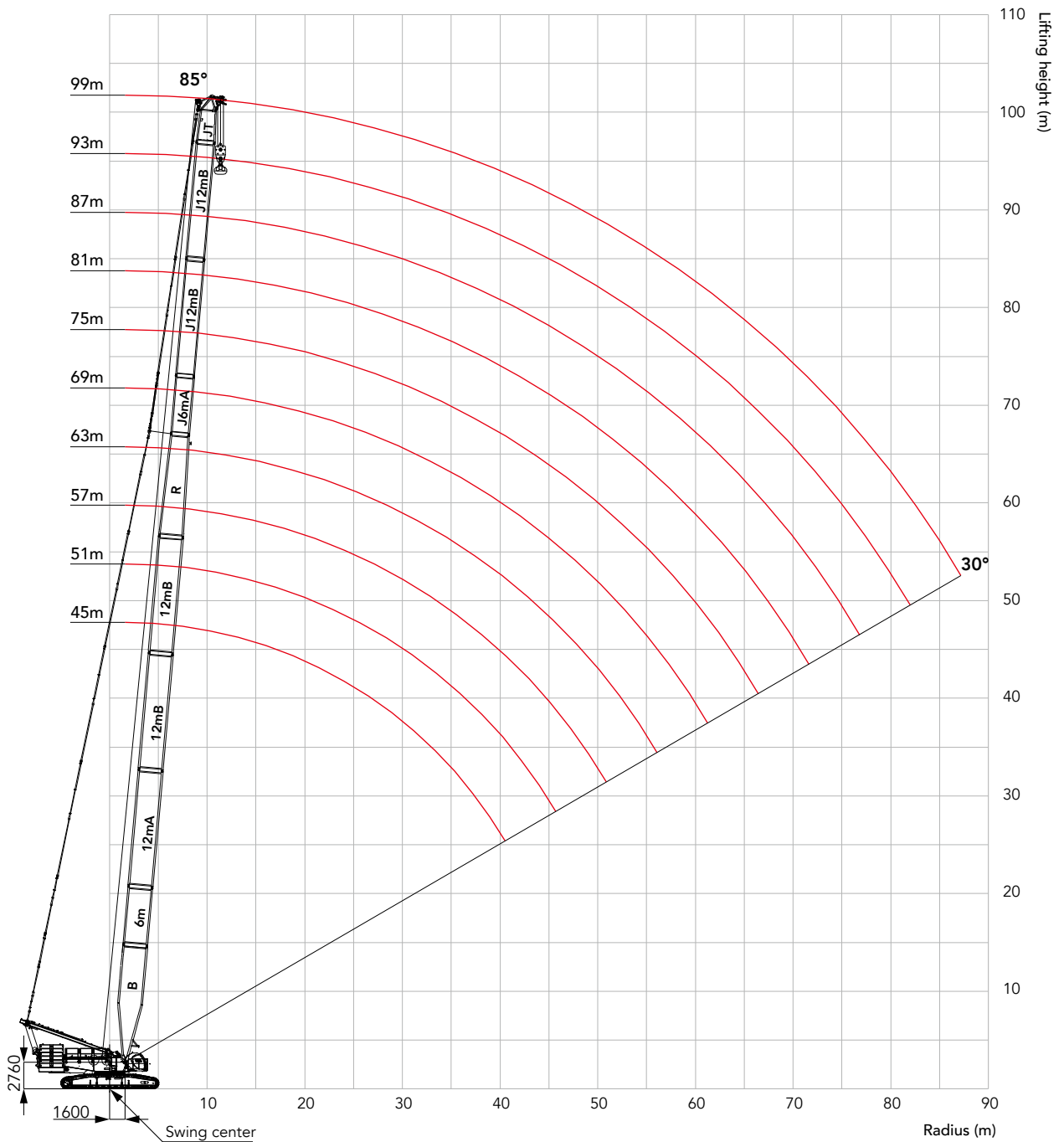

Load Chart of HJ

Note:

1. The rated load in the load chart is calculated complying with EN13000;
2. The working radius is the horizontal distance from the load center to the swing center;
3. The actual lifting capacity must subtract the weight of hooks and other riggings from the rated capacity in the load chart;
4. The load value is calculated when the object is hung freely, without considering the influence of wind on the load, ground conditions and slope, operation speed and the influence of any other negative factors over safe operation. Therefore, the operator bears the responsibility of making a judgment and decreasing the load and lowering speed;
5. All ratings are calculated when the machine is parking on firm and level ground with less than 1% gradient.

Load chart-HJ

Boom length 45-99m, Rear counterweight 150t, Carbody counterweight 40t

Radius(m)	45	51	57	63	69	75	81	87	93	99	Radius(m)
7	196										7
8	197	195	192								8
9	197	196	192	189	187						9
10	199	197	193	185	177	170	162				10
11	192	183	176	168	162	156	149	123	121		11
12	174	167	161	154	148	143	137	120	120	101	12
14	147	141	136	131	126	123	118	114	110	97.9	14
16	126	122	118	114	110	107	103	100	96.9	94.1	16
18	110	107	104	100	97.2	94.6	91.4	88.7	85.8	83.5	18
20	97.2	95.1	92.5	89.3	86.6	84.4	80.3	79.2	76.7	74.7	20
22	85.2	84.7	83	80.2	77.8	75.9	70.8	71.2	69	67.2	22
24	75.6	75	74.8	72.5	70.3	68.2	63.1	64.5	62.4	60.9	24
26	67.6	67.1	66.9	65.9	64	60.8	56.4	58.7	56.8	55.4	26
28	61	60.5	60.2	59.4	58.5	54.4	50.4	53.6	51.9	50.6	28
30	55.4	54.9	54.6	53.8	53.3	49.1	45	49.2	47.6	46.4	30
32	50.6	50	49.8	49	48.5	44.3	40.6	45.3	43.8	42.7	32
34	46.4	45.9	45.6	44.8	44.3	40	36.6	41.8	40.4	39.3	34
36	42.7	42.2	41.9	41.1	40.6	36.5	33	38.7	37.3	36.3	36
38	39.4	38.9	38.6	37.8	37.3	32.9	29.4	35.9	34.5	33.6	38
40	36.5	36	35.7	34.9	34.4	29.9	26.4	33	32	31.2	40
44		31	30.8	30	29.5	24.3	21.2	28	27.4	26.9	44
48			26.7	25.9	25.4	19.7	16.8	24	23.3	23	48
52				22.5	22	15.9	13	20.6	19.9	19.6	52
56				19.5	19.1	12.5	10	17.7	17	16.7	56
60					16.6	9.7	7	15.2	14.5	14.3	60
64						7	4.6	13	12.4	12.1	64
68							2.2	11.1	10.5	10.2	68
72								9.4	8.8	8.5	72
76								7.9	7.3	7	76
80									5.9	5.7	80
84										4.4	84

Boom Combination in HJDB

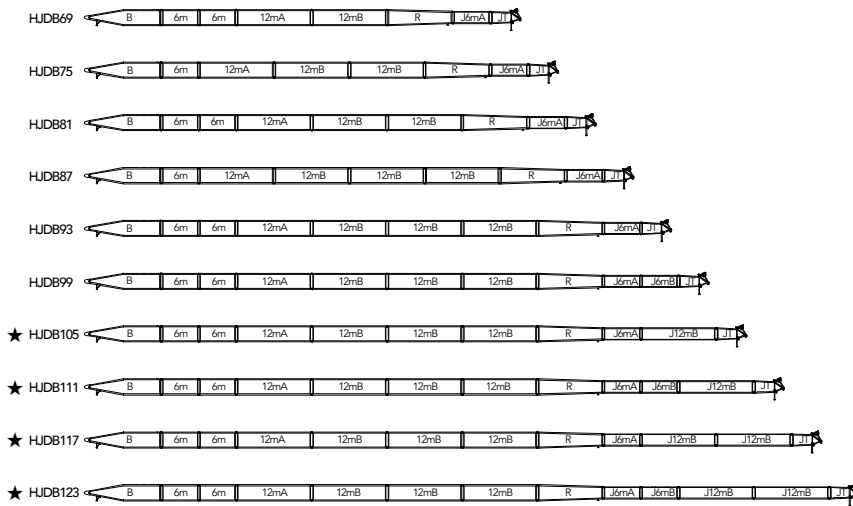

	Boom base
	Boom insert
	Boom insert
	Boom insert
	Tapered insert
	Jib top
	Jib insert
	Jib insert
	Jib insert
	Jib insert

Note:

- 1.The 12m boom base, 10.5m tapered insert, 6m luffing jib insert A and 4.5m jib top are must.
- 2.For combinations marked with " ★ ", the mid-suspension cable must be used, otherwise, the boom system may break.

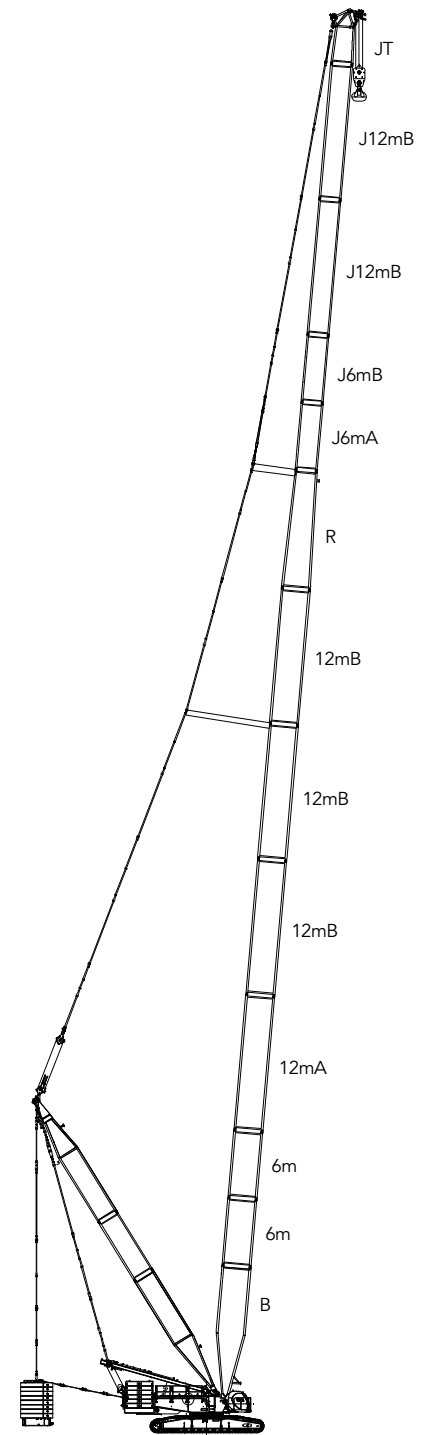

HJDB Configuration
(69m~123m)

Working Radius in HJDB

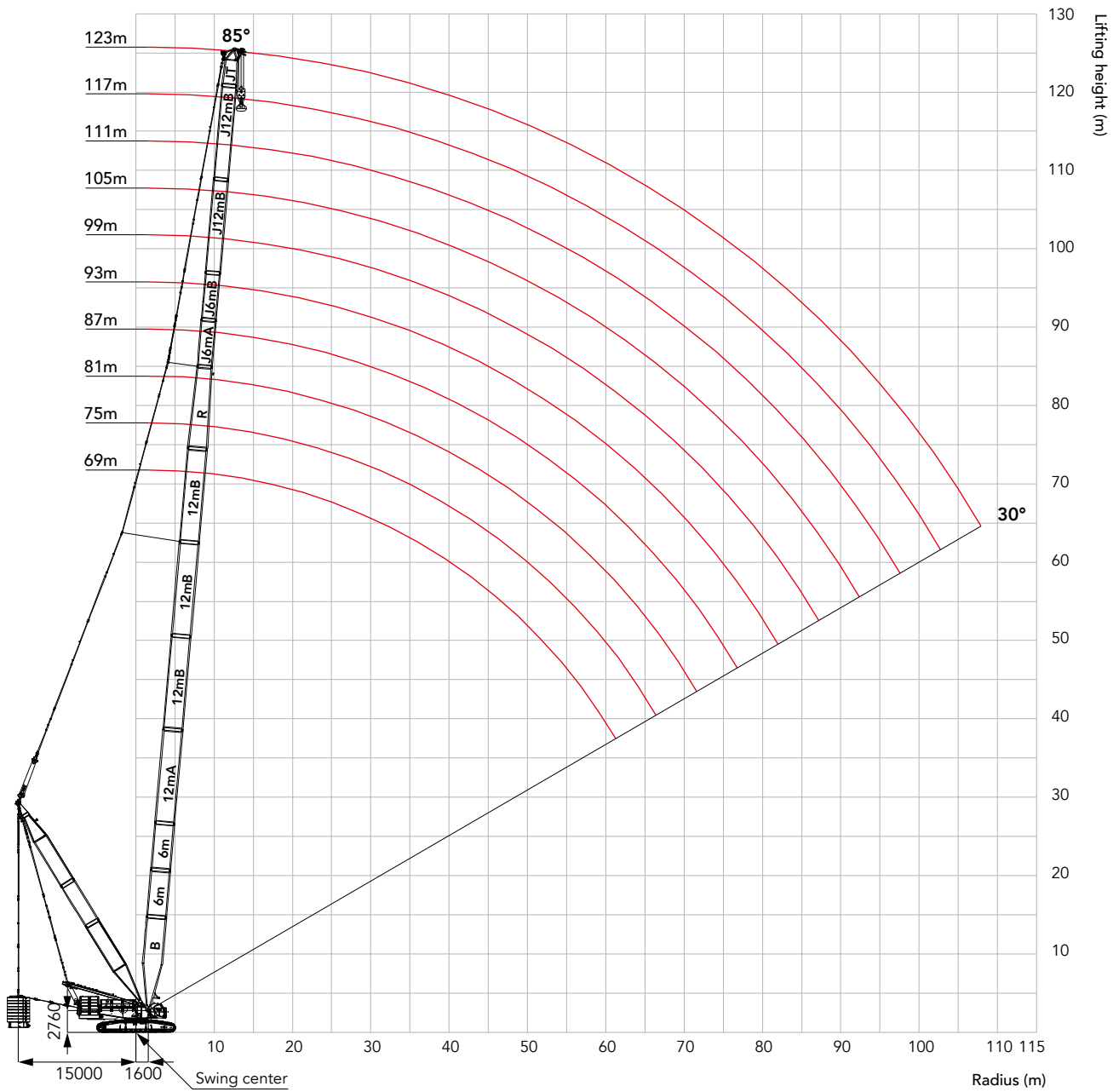

Unit:t

Load Chart of HJDB

Note:

- 1.The rated load in the load chart is calculated complying with EN13000;
- 2.The working radius is the horizontal distance from the load center to the swing center;
- 3.The actual lifting capacity must subtract the weight of hooks and other riggings from the rated capacity in the load chart;
- 4.The load value is calculated when the object is hung freely,without considering the influence of wind on the load, ground conditions and slope, operation speed and the influence of any other negative factors over safe operation. Therefore, the operator bears the responsibility of making a judgment and decreasing the load and lowering speed;
- 5.All ratings are calculated when the machine is parking on firm and level ground with less than 1% gradient;
- 6.See the Operation Manual for the complete load charts of HJDB Configuration.

Load chart-HJDB

Boom length 69-123m,Superlift radius 15m,Superlift counterweight 0t,
Rear counterweight 150t,Carbody counterweight 40t

Radius(m)	69	75	81	87	93	99	105	111	117	123	Radius(m)
9	190										9
10	183	183	183								10
11	162	162	161	161	141						11
12	145	145	144	144	142	122	105				12
14	119	119	118	118	117	117	105	91.5	79.9	69.6	14
16	100	100	99.6	99.1	98.3	98	97.9	91.6	79.8	69.1	16
18	86.5	86.1	85.3	84.8	84	83.6	83.5	83.1	79.7	68.5	18
20	75.4	74.9	74.1	73.6	72.7	72.3	72.2	71.7	71.5	67.9	20
22	66.4	66	65.1	64.6	63.7	63.3	63.1	62.7	62.4	61.9	22
24	59	58.6	57.7	57.1	56.2	55.8	55.7	55.2	54.9	54.4	24
26	52.9	52.4	51.5	50.9	50	49.6	49.4	48.9	48.7	48.1	26
28	55.6	47.2	46.3	45.7	44.7	44.3	44.1	43.6	43.3	42.8	28
30	50.5	50.1	41.7	41.1	40.2	39.8	39.6	39.1	38.8	38.2	30
32	46	45.6	44.8	37.2	36.2	35.8	35.6	35.1	34.8	34.2	32
34	42.1	41.6	40.8	40.3	32.8	32.3	32.1	31.6	31.3	30.7	34
36	38.6	38.2	37.3	36.8	35.9	29.3	29.1	28.5	28.2	27.7	36
38	40.9	35	34.2	33.7	32.8	32.3	26.3	25.8	25.5	24.9	38
40	37.7	32.2	31.4	30.9	30	29.5	29.4	23.3	23	22.4	40
44	32.2	32	31.2	26	25.1	24.7	24.6	24.1	23.8	18.2	44
48	27.7	27.4	26.7	26.2	21.1	20.7	20.6	20.1	19.8	19.2	48
52	23.8	23.6	22.9	22.4	21.6	17.3	17.2	16.7	16.4	15.9	52
56	20.5	20.2	19.6	19.1	18.3	18	17.9	13.8	13.5	13	56
60	17.5	17.3	16.7	16.3	15.5	15.1	15.1	14.6	11	10.5	60
64		14.8	14.1	13.7	13	12.6	12.6	12.2	12	8.3	64
68			11.9	11.5	10.7	10.4	10.4	10	9.8	9.3	68
72			9.8	9.5	8.7	8.4	8.4	8	7.8	7.3	72
76				7.6	6.9	6.7	6.6	6.2	6.1	5.6	76
80					5.3	5	5	4.6	4.5	4	80
84						3.5	3.5	3.2	3	2.5	84
88							2.2	1.8	1.7	1.2	88
92							0.9	0.6	0.5		92

Load Chart of HJDB

Load chart-HJDB											
Boom length 69-123m,Superlift radius 15m,Superlift counterweight 100t, Rear counterweight 150t,Carbody counterweight 40t											
Radius(m)	69	75	81	87	93	99	105	111	117	123	Radius(m)
9	190*										9
10	190	187	184								10
11	190	187	184	161	141*						11
12	190	187	185	161	142	122*	105*				12
14	192	190	186	161	141	123	105*	91.5*	79.9*	69.6*	14
16	193	189	186	161	141	123	105	91.6*	79.8*	69.1*	16
18	191	190	188	161	141	122	105	91.7	79.7	68.5*	18
20	168	168	167	161	141	122	104	91.7	79.4	67.9	20
22	150	150	149	148	141	122	104	91.7	78.7	67.2	22
24	135	135	134	133	132	122	104	89.1	75.5	64.8	24
26	123	122	121	121	120	120	104	85.9	72.7	61.9	26
28	120	112	111	110	109	109	104	82.8	69.9	59.8	28
30	110	110	102	101	100	100	100	79.7	67.1	57.4	30
32	102	102	101	93.6	92.7	92.3	92.1	77.2	64.8	55	32
34	94.9	94.6	93.7	93.2	85.7	85.3	85.1	74.6	62.5	53	34
36	88.4	88	87.2	86.6	85.7	79.1	78.9	72.1	60.6	51.3	36
38	86.6	82.1	81.3	80.8	79.9	79.5	73.5	69.6	58.3	49.3	38
40	81.3	76.9	76	75.5	74.6	74.2	74.1	67.6	56.5	47.7	40
44	72.2	71.6	70.6	66.5	65.6	65.2	65	63.2	53.3	44.9	44
48	64.3	64	63	62.3	58.1	57.7	57.5	57	50.2	42.2	48
52	57.4	57.2	56.6	55.9	54.8	51.3	51.2	50.7	47.7	39.9	52
56	51.5	51.4	50.8	50.5	49.4	48.7	48.2	45.3	45	37.6	56
60	46.5	46.3	45.8	45.4	44.7	44	43.6	42.8	40.4	36.1	60
64		41.9	41.4	41	40.4	39.9	39.5	38.7	38.2	34.4	64
68			37.5	37.2	36.5	36.2	35.9	35.2	34.6	33.1	68
72			34	33.7	33	32.8	32.7	32	31.5	30.7	72
76				30.6	29.9	29.7	29.7	29.2	28.7	27.9	76
80					27.1	26.9	26.9	26.5	26.2	25.4	80
84						24.3	24.3	23.9	23.8	23.1	84
88							22	21.6	21.5	21	88
92							19.9	19.5	19.4	18.9	92
96								17.6	17.5	17	96
100									15.7	15.2	100
104										13.6	104
108										12	108

Note:For values marked with "**", the superlift counterweight shall not leave the ground.

Boom Combination in HJFJ

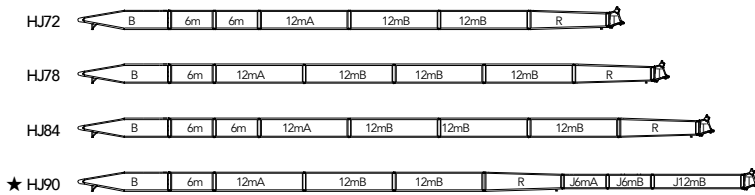

	Boom base
	Boom insert
	Boom insert
	Boom insert
	Tapered insert
	Boom tip
	Jib base
	Jib top
	Jib insert
	Jib insert
	Jib insert

Note:

- 1.The 12m boom base and 10.5m tapered insert are must. For jib combination, the 4.5m jib base, 6m luffing jib insert A, and 4.5m jib top are must.
- 2.For combinations marked with " ★ ", the mid-point suspension cable must be used, otherwise, the boom system may break.

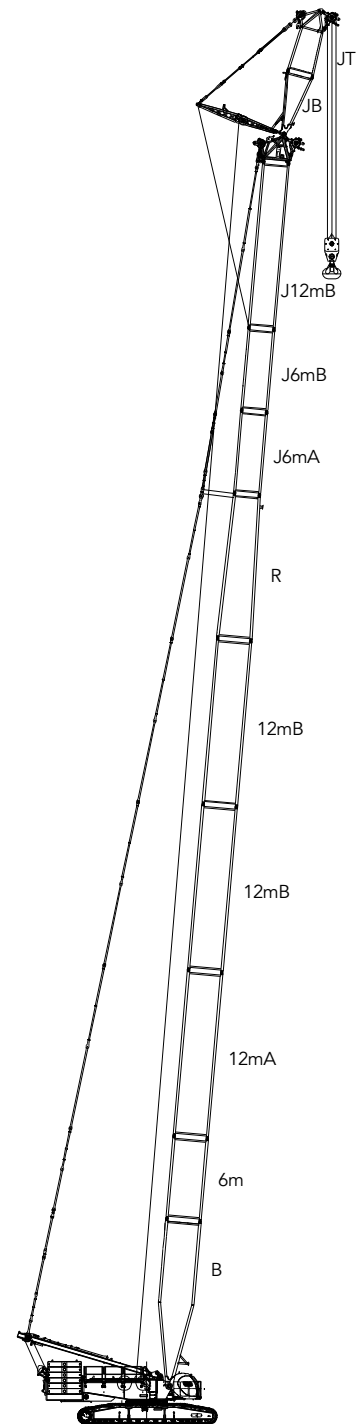

**HJFJ onfiguration
(72m~90m)+9m**

Working Radius in HJFJ

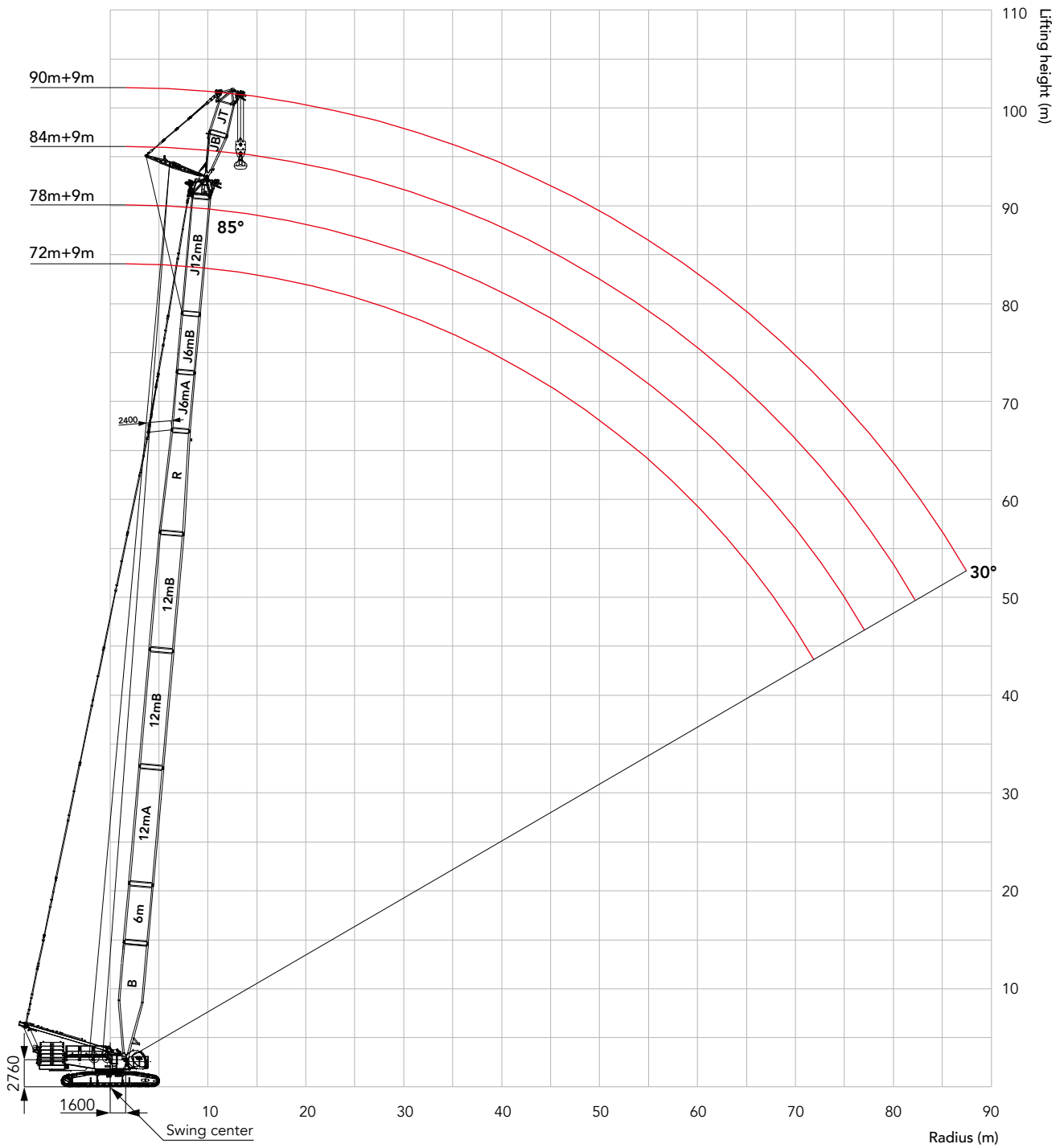

Unit:t

Load Chart of HJFJ**Note:**

- 1.The rated load in the load chart is calculated complying with EN13000;
- 2.The working radius is the horizontal distance from the load center to the swing center;
- 3.The actual lifting capacity must subtract the weight of hooks and other riggings from the rated capacity in the load chart;
- 4.The load value is calculated when the object is hung freely,without considering the influence of wind on the load, ground conditions and slope, operation speed and the influence of any other negative factors over safe operation. Therefore, the operator bears the responsibility of making a judgment and decreasing the load and lowering speed;
- 5.All ratings are calculated when the machine is parking on firm and level ground with less than 1% gradient;
- 6.See the Operation Manual for the complete load charts of HJFJ Configuration.

Load chart-HJFJ

Boom length 90m,Jib length 9m,Rear counterweight 150t,Carbody counterweight 40t,Boom to Jib angle 10°, 15°, 20°

Radius(m)	10°	15°	20°	Radius(m)
14				14
16	72.8	67.3	62.1	16
18	71.1	65.9	61	18
20	69.2	64.1	60.2	20
22	63.1	63.1	59.1	22
24	56.5	57.1	57.5	24
26	50.7	51.3	51.7	26
28	45.8	46.3	46.6	28
30	41.4	41.8	42.1	30
32	37.5	37.9	38.2	32
34	34	34.4	34.6	34
36	30.9	31.2	31.4	36
38	28	28.4	28.6	38
40	25.5	25.8	26	40
44	21	21.2	21.4	44
48	17.2	17.4	17.5	48
52	13.9	14.1	14.2	52
56	11.1	11.2	11.3	56
60	8.6	8.8	8.8	60
64	6.5	6.5	6.6	64
68	4.5	4.6	4.6	68
72	2.8	2.8	2.8	72
76	1.2	1.2	1.2	76
78				78

Boom Combination in FJh

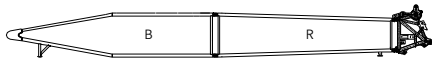

	Boom base
	Tapered insert
	Boom tip
	Jib base
	Jib top

Note:

The 24m basic boom consists of 12m boom base, 10.5m tapered insert and 1.5m boom tip. The 9m jib combination of FJh Configuration is the same as that of HJFJ Configuration.

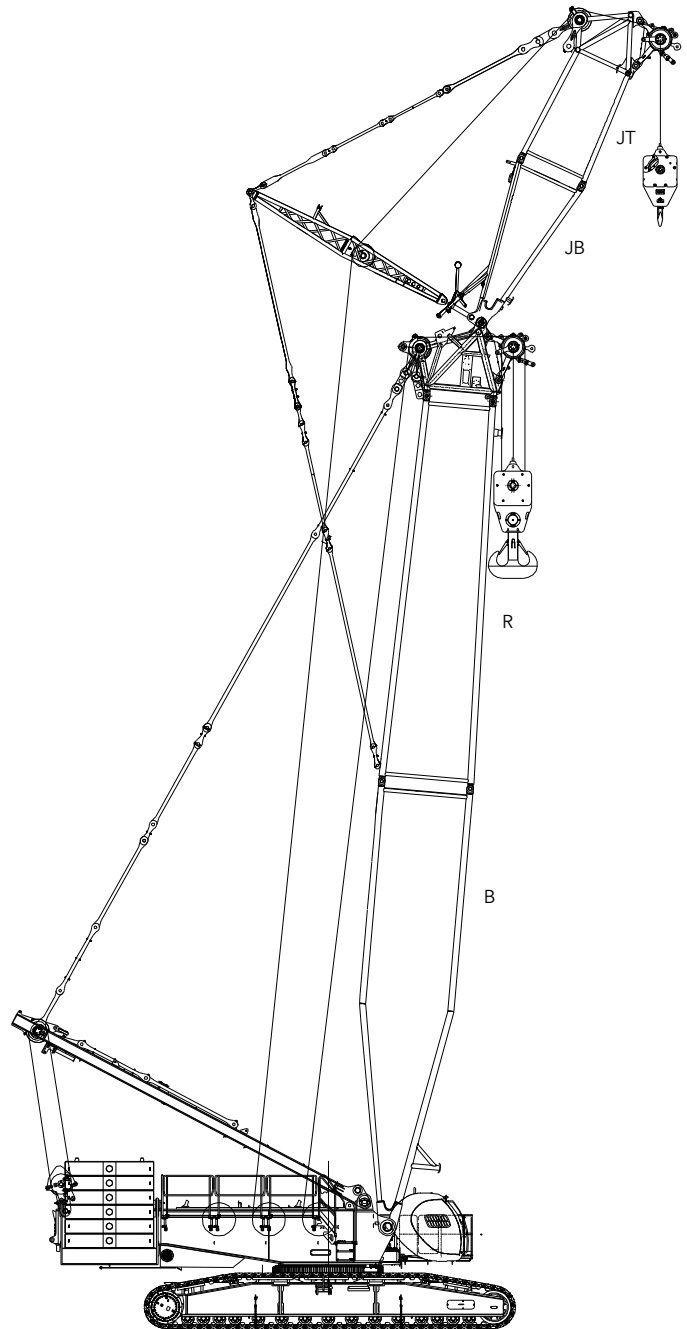

**FJh Configuration
(24m+9m)**

Working Radius of FJh

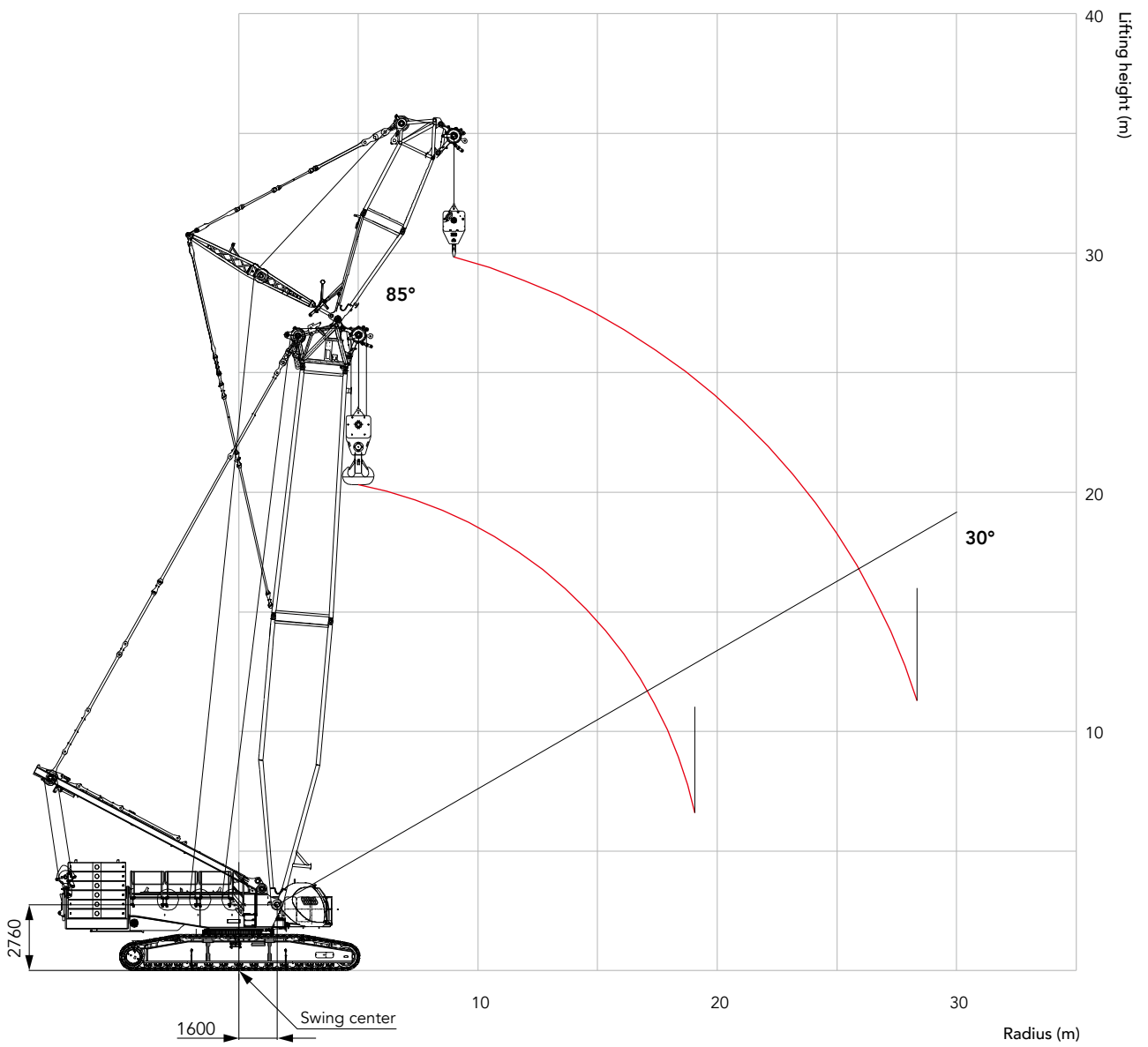

Load Chart of FJh

Note:

- 1.The rated load in the load chart is calculated complying with EN13000;
- 2.The working radius is the horizontal distance from the load center to the swing center;
- 3.The actual lifting capacity must subtract the weight of hooks and other riggings from the rated capacity in the load chart;
- 4.The load value is calculated when the object is hung freely,without considering the influence of wind on the load, ground conditions and slope, operation speed and the influence of any other negative factors over safe operation. Therefore, the operator bears the responsibility of making a judgment and decreasing the load and lowering speed;
- 5.All ratings are calculated when the machine is parking on firm and level ground with less than 1% gradient;
- 6.See the Operation Manual for the complete load charts of FJh Configuration.

Load chart-FJh

Boom length 24m,Jib length 9m,Rear counterweight 150t,Carbody counterweight 40t,Boom to Jib angle 20°

Radius(m)	Boom length(m)	Jib length(m)	Radius(m)
	24	9	
4			4
5.5	400		5.5
6	400		6
7	379		7
8	325		8
9	283		9
10	246	167	10
11	217	160	11
12	193	153	12
14	152	142	14
16	124	132	16
18	103	112	18
20	88.2	96.4	20
22	76	84	22
24		74	24
26		65.7	26
28		58.7	28
30		52.8	30
32		47.5	32
34			34

Boom Combination in FJhDB

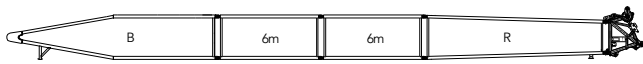

	Boom base
	Boom insert
	Tapered insert
	Boom tip
	Jib base
	Jib top

Note:

The 24m basic boom consists of 12m boom base, 10.5m tapered insert and 1.5m boom tip. For jib combination, the 4.5m jib base, and 4.5m jib top are must.

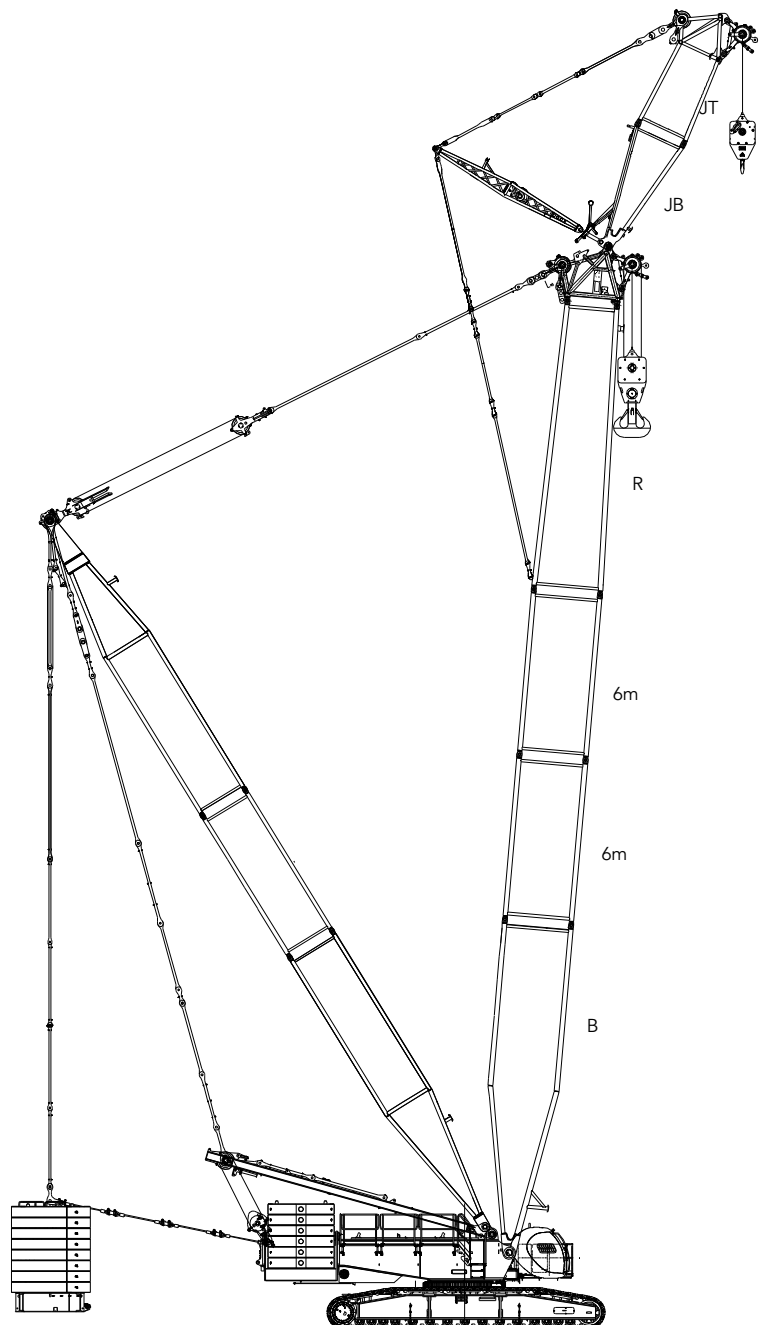

**FJhDB Configuration
(36m+9m)**

Working Radius of FJhDB

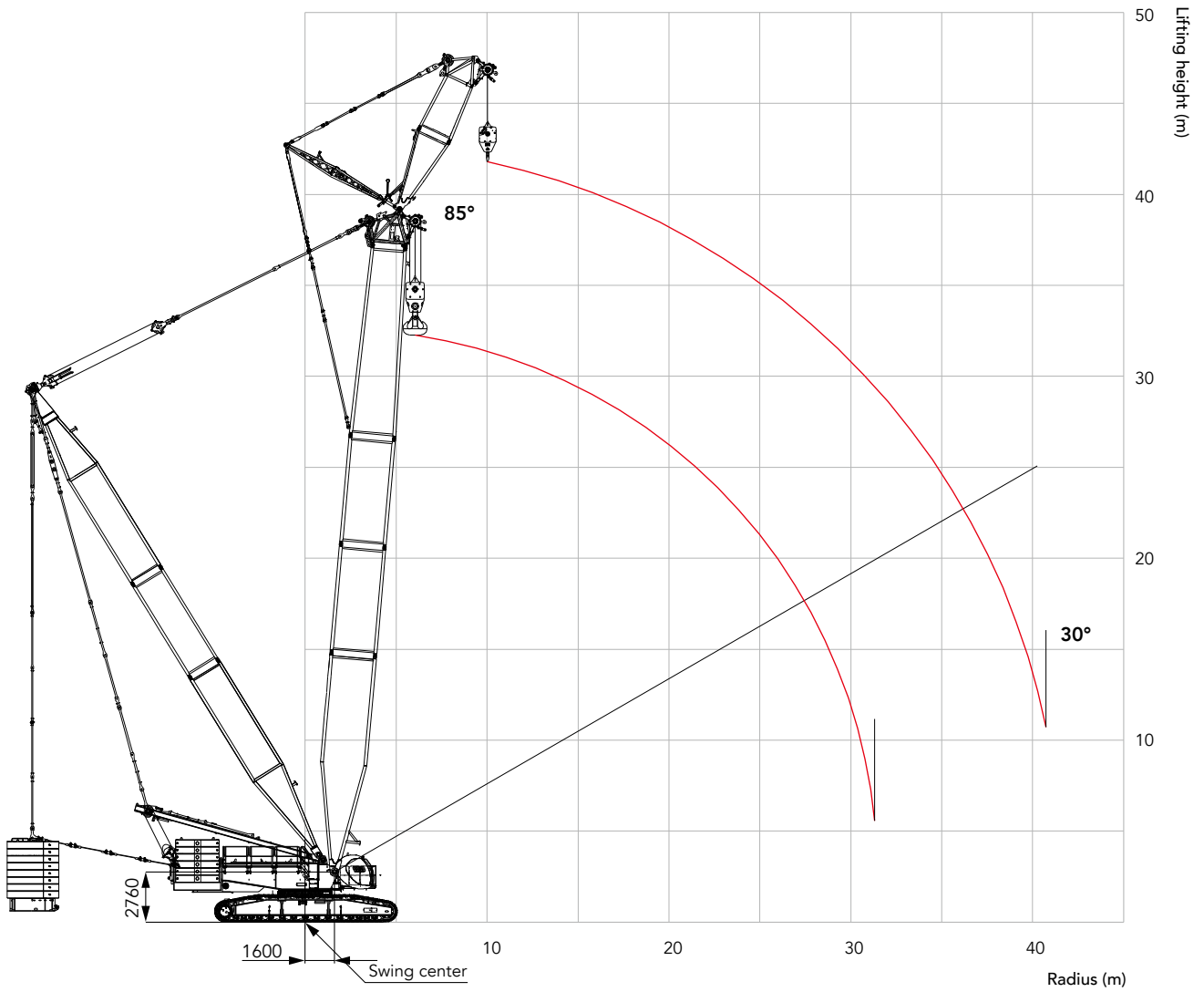

Unit:t

Load Chart of FJhDB**Note:**

- 1.The rated load in the load chart is calculated complying with EN13000;
- 2.The working radius is the horizontal distance from the load center to the swing center;
- 3.The actual lifting capacity must subtract the weight of hooks and other riggings from the rated capacity in the load chart;
- 4.The load value is calculated when the object is hung freely,without considering the influence of wind on the load, ground conditions and slope, operation speed and the influence of any other negative factors over safe operation. Therefore, the operator bears the responsibility of making a judgment and decreasing the load and lowering speed;
- 5.All ratings are calculated when the machine is parking on firm and level ground with less than 1% gradient;
- 6.See the Operation Manual for the complete load charts of FJhDB Configuration.

Load chart-FJhDB

Boom length 36m, Jib length 9m, Superlift radius 15m, Superlift counterweight 100t, Rear counterweight 150t,
Carbody counterweight 40t, Boom to Jib angle 20°

Radius(m)	Boom length(m)		Jib length(m)		Radius(m)
	36		9		
6					6
7		400			7
8		400			8
9		400			9
10		376			10
11		333		169	11
12		299		164	12
14		247		153	14
16		225		145	16
18		194		137	18
20		170		131	20
22		158		125	22
24		142		119	24
26		129		115	26
28		117		110	28
30		107		107	30
32		98.7		104	32
34				96.9	34
36				89.7	36
38				74.2	38
40				69.4	40
42					42

Boom Combination in LJ

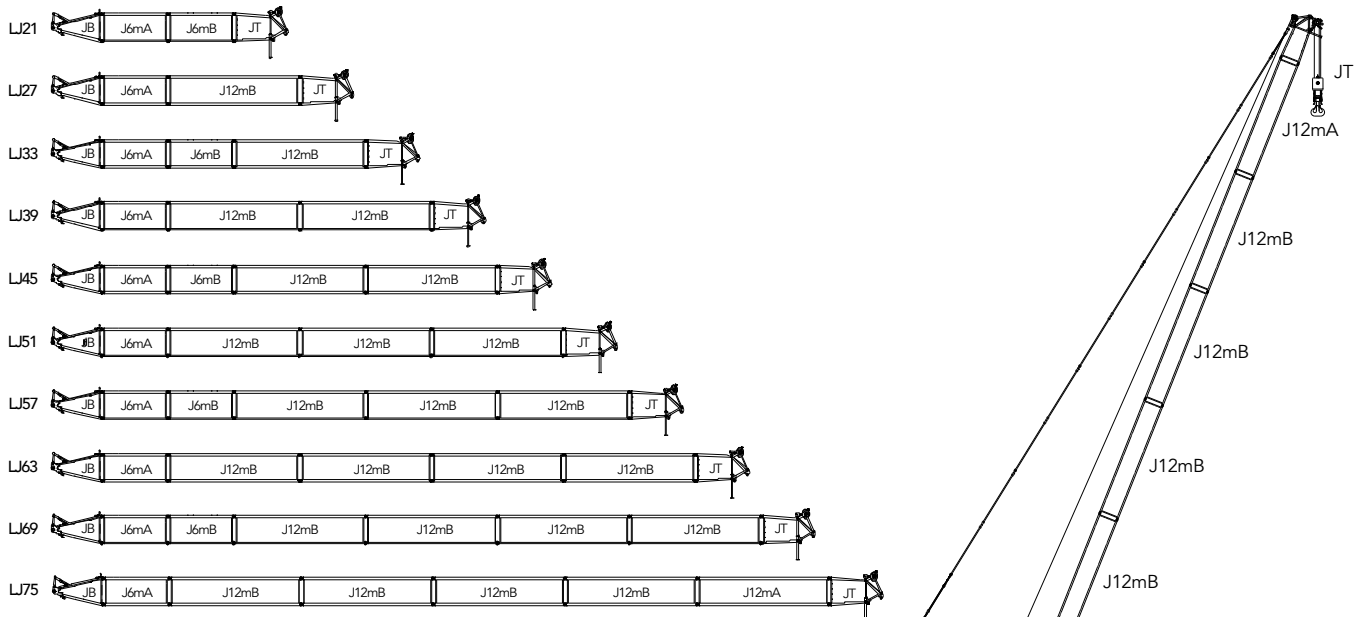

	Boom base
	Boom insert
	Boom insert
	Boom insert
	Tapered insert
	Boom tip
	Jib base
	Jib top
	Jib insert
	Jib insert
	Jib insert
	Jib insert

Note: The 36m~60m boom combination is the same as that of the H Configuration. For jib combination, the 4.5m jib base, 6m luffing jib insert A, and 4.5m jib top are must.

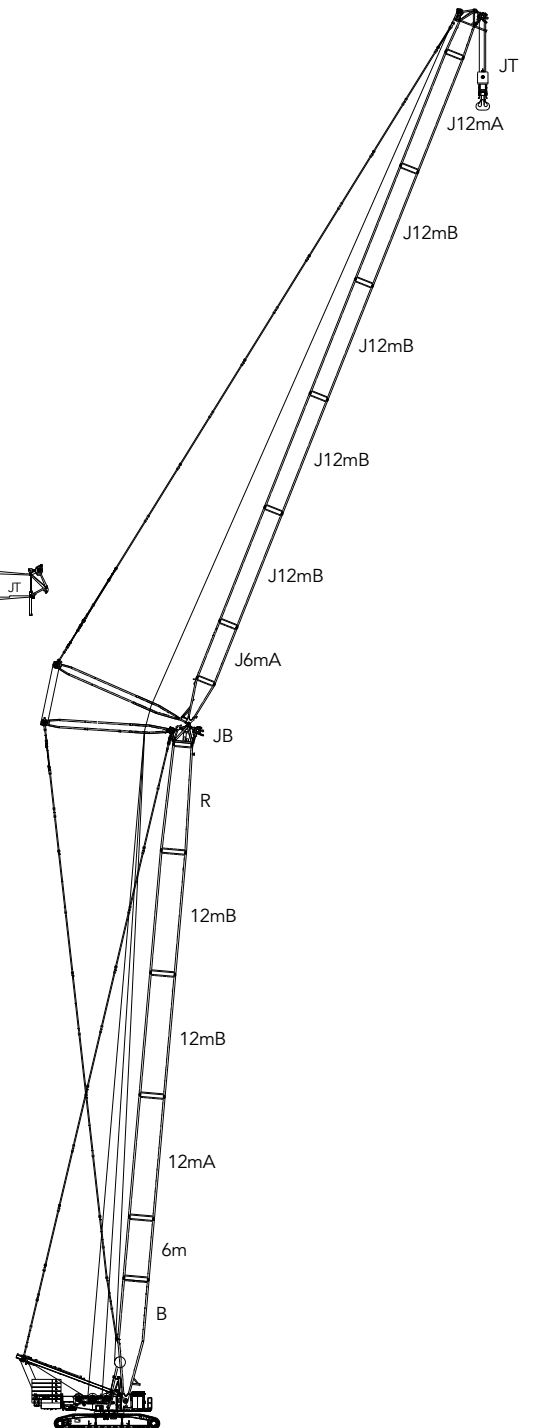

LJ Configuration
(36m~66m)+(21m~75m)

Working Radius in LJ

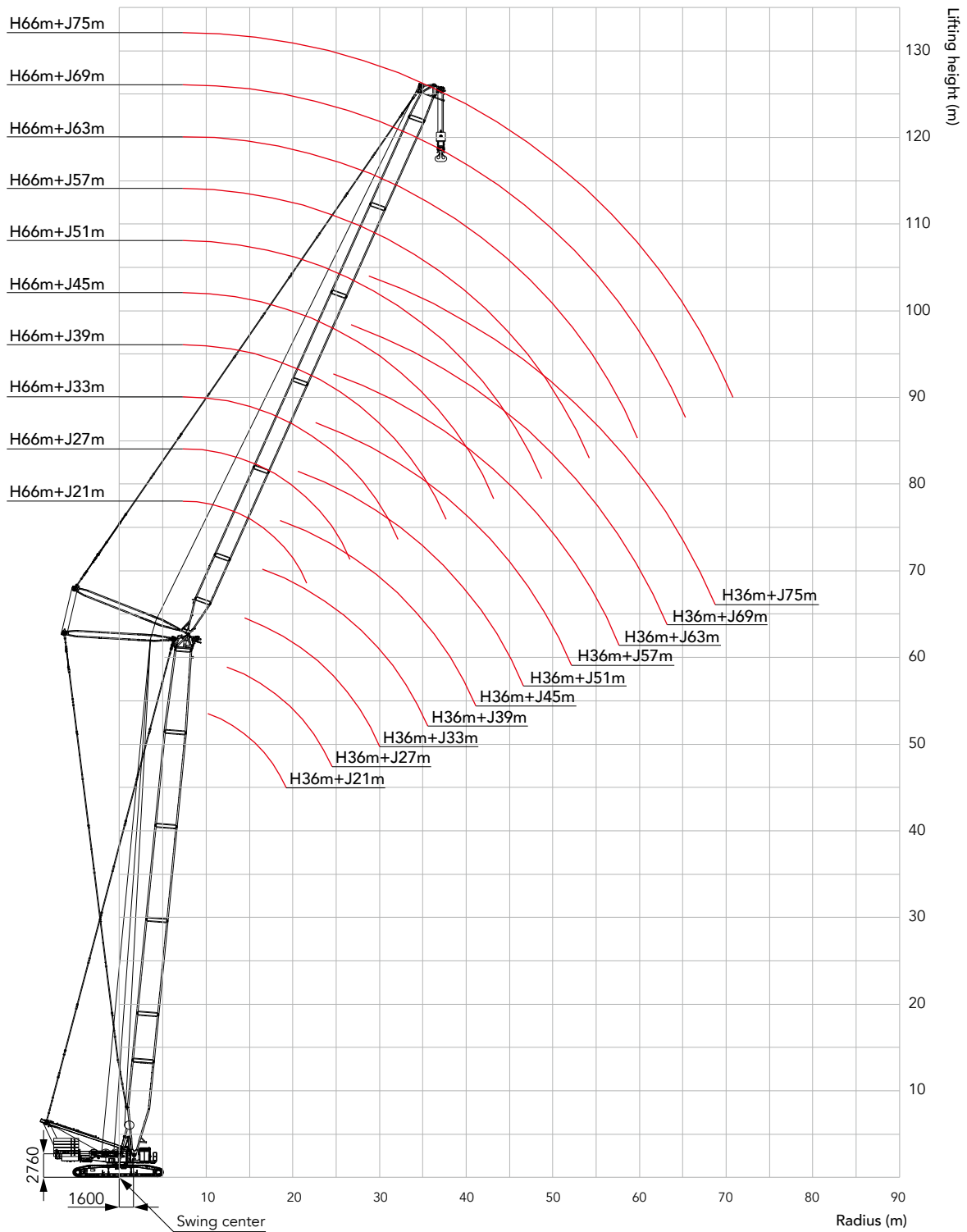

Load Chart of LJ

Note:

- 1.The rated load in the load chart is calculated complying with EN13000;
- 2.The working radius is the horizontal distance from the load center to the swing center;
- 3.The actual lifting capacity must subtract the weight of hooks and other riggings from the rated capacity in the load chart;
- 4.The load value is calculated when the object is hung freely,without considering the influence of wind on the load, ground conditions and slope, operation speed and the influence of any other negative factors over safe operation. Therefore, the operator bears the responsibility of making a judgment and decreasing the load and lowering speed;
- 5.All ratings are calculated when the machine is parking on firm and level ground with less than 1% gradient;
- 6.See the Operation Manual for the complete load charts of LJ Configuration.

Load chart-LJ 1/6 (Jib 21-75m,Rear counterweight 150t,Carbody counterweight 40t)

Boom 36m																
Jib	21			27			33			39			45			Jib
Angle	85°	75°	65°	85°	75°	65°	85°	75°	65°	85°	75°	65°	85°	75°	65°	Angle
12	168															12
14	144			139												14
16	126			122			117									16
18	112			108			104			101			98.5			18
20	100			97.7			94.5			91.7			88.9			20
22	91.5	82.7		88.7			85.8			83.4			80.8			22
24	83.8	75.5		81.2	73.3		78.6			76.3			74			24
26		69.3		74.8	67.4		72.4			70.3			68.2			26
28		62.9		68.8	62.3		67	60.2		65.1			63.2			28
30		57.5		62.8	57.3		62.3	55.9		60.6	54.2		58.7			30
32		52.5	48.1		52.7		57.5	52		56.6	50.6		54.8	48.8		32
34			44.3		48.6	43.9	53.1	48		52.8	47.3		51.3	45.6		34
36			41		45	40.7	49.2	44.5		49	44.1		48.2	42.8		36
38			37.9			37.9		41.4	37.1	45.6	41		45.1	40.2		38
40						35.3		38.6	34.6	42.6	38.3		42.1	37.6		40
44									30.3		33.6	29.8	37	32.9		44
48									26.7		29.6	26.3	32.7	29.1	25.5	48
52												23.3		25.8	22.6	52
56															20.1	56
60															17.9	60

Jib	51			57			63			69			75			Jib
Angle	85°	75°	65°	85°	75°	65°	85°	75°	65°	85°	75°	65°	85°	75°	65°	Angle
20	86.3															20
22	78.5			76.1												22
24	71.9			69.8			67.8									24
26	66.3			64.3			62.4			58.7			49.2			26
28	61.4			59.5			57.8			56			48.6			28
30	57.1			55.3			53.7			52			48			30
32	53.3			51.6			50.1			48.5			47.3			32
34	49.9			48.3			46.8			45.3			44.2			34
36	46.8	41.4		45.3			43.9			42.5			41.4			36
38	44.1	38.9		42.6	37.4		41.3			39.9			38.9			38
40	41.6	36.6		40.2	35.2		38.9	33.9		37.6			36.6			40
44	36.6	32.4		35.9	31.3		34.7	30.1		33.5	28.8		32.5			44
48	32.4	28.6	24.8	31.8	27.9		31.2	26.9		30	25.7		29.1	24.8		48
52	28.8	25.4	22	28.3	24.7	21.2	27.8	24.1		27	23		26.2	22.2		52
56		22.6	19.6	25.3	22	18.8	24.8	21.4	18.1	24.2	20.7		23.3	19.9		56
60		20.2	17.4	22.6	19.7	16.7	22.3	19.1	16	21.7	18.4	15.2	20.4	17.9		60
64			15.6		17.6	14.9	20	17.1	14.3	19.5	16.4	13.5	17.8	16	13	64
68						13.3		15.3	12.7	17.5	14.7	11.9	15.4	14.3	11.5	68
72						11.8		13.7	11.3	15.7	13.1	10.5	13.4	12.7	10.1	72
76									10		11.7	9.3	11.6	11.3	8.9	76
80												8.1		10.1	7.7	80
84												7		8.9	6.7	84
88															5.8	88

Unit:t

Load Chart of LJ

Load chart-LJ 2/6 (Jib 21-75m,Rear counterweight 150t,Carbody counterweight 40t)

Boom 42m																
Jib	21			27			33			39			45			Jib
Angle	85°	75°	65°	85°	75°	65°	85°	75°	65°	85°	75°	65°	85°	75°	65°	Angle
14	138			133												14
16	121			117			113									16
18	108			104			101			98						18
20	97.2			94.3			91.2			88.5			85.8			20
22	88.4			85.8			83			80.6			78.1			22
24	81	71.6		78.6			76.1			73.9			71.6			24
26	74.9	65.9		72.5	63.9		70.1			68.1			66.1			26
28		60.9		67.2	59.1		65	57.1		63.2			61.2			28
30		56.1		62.6	55		60.5	53		58.8			57			30
32		51.5		57.3	51.3		56.6	49.5		54.9	47.9		53.2			32
34			42.3		47.4		52.8	46.3		51.5	44.8		49.8	43.1		34
36			39.1		43.9		48.9	43.3		48.4	42.1		46.8	40.5		36
38			36.3		40.8	35.9		40.3		45.4	39.6		44.1	38		38
40			33.7			33.5		37.6	32.7	42.3	37.1		41.7	35.8		40
44						29.3		32.9	28.6		32.6	28	36.8	31.9		44
48									25.2		28.8	24.7	32.5	28.2	23.8	48
52									22.2			21.9		25	21.1	52
56												19.4		22.2	18.8	56
60															16.7	60

Jib	51			57			63			69			75			Jib
Angle	85°	75°	65°	85°	75°	65°	85°	75°	65°	85°	75°	65°	85°	75°	65°	Angle
22	75.9			73.5												22
24	69.6			67.5			65.5									24
26	64.2			62.2			60.4			55.6						26
28	59.5			57.6			55.9			54.2			46.3			28
30	55.3			53.6			52			50.3			45.8			30
32	51.7			50			48.5			46.9			45.2			32
34	48.4			46.8			45.4			43.9			42.7			34
36	45.4	39.1		43.9			42.6			41.1			40			36
38	42.8	36.7		41.3			40			38.6			37.6			38
40	40.4	34.6		39	33.1		37.7			36.4			35.4			40
44	36.2	30.8		34.9	29.5		33.7	28.3		32.4	26.9		31.5			44
48	32.2	27.6		31.4	26.4		30.3	25.2		29	23.9		28.2	23.1		48
52	28.6	24.5	20.4	28.1	23.7		27.3	22.6		26.2	21.4		25.4	20.6		52
56		21.8	18.1	25.1	21.2	17.3	24.6	20.4		23.7	19.2		22.9	18.4		56
60		19.5	16.1	22.5	18.9	15.3	22.1	18.3	14.6	21.5	17.3		20.7	16.5		60
64			14.4		16.9	13.6	19.8	16.4	13	19.3	15.5	11.9	17.9	14.8	11.1	64
68			12.8		15.1	12.1		14.6	11.5	17.3	13.9	10.5	15.7	13.3	9.8	68
72						10.7		13.1	10.1	15.5	12.4	9.3	13.8	12	8.6	72
76									8.9		11	8.2	12	10.7	7.6	76
80									7.8			7.1		9.5	6.6	80
84												6.1		8.3	5.7	84
88															4.8	88
92															4	92

Load Chart of LJ

Load chart-LJ 3/6
(Jib 21-75m,Rear counterweight 150t,Carbody counterweight 40t)

Boom 48m

Jib	21			27			33			39			45			Jib
	85°	75°	65°	85°	75°	65°	85°	75°	65°	85°	75°	65°	85°	75°	65°	
14	132															14
16	116			112			108									16
18	104			100			97.4			94.4						18
20	93.8			91			88			85.4			82.7			20
22	85.4			82.9			80.2			77.9			75.4			22
24	78.3			76			73.6			71.5			69.2			24
26	72.4	62.2		70.2			67.9			66			63.9			26
28		57.6		65.1	55.8		63			61.2			59.3			28
30		53.5		60.7	51.9		58.7	50		57			55.2			30
32		49.9		56.9	48.5		54.9	46.7		53.3			51.6			32
34		46.2			45.4		51.5	43.7		50	42.2		48.3			34
36			36.9		42.6		48.5	41		47	39.6		45.4	38		36
38			34.3		39.7		45.2	38.6		44.3	37.3		42.8	35.7		38
40			31.9		36.9	31.4		36.4		41.9	35.1		40.5	33.7		40
44						27.5		31.9	26.7	36.9	31.4		36.3	30		44
48						24.1			23.5	27.8	22.9		32.3	27		48
52									20.8	24.6	20.3			24.1	19.4	52
56											18			21.4	17.2	56
60											15.9				15.3	60
64															13.6	64

Jib	51			57			63			69			75			Jib
	85°	75°	65°	85°	75°	65°	85°	75°	65°	85°	75°	65°	85°	75°	65°	
22	73.2															22
24	67.2			65.1			62.7									24
26	62.1			60.1			58.3			52.4						26
28	57.5			55.7			54			51.9			43.8			28
30	53.6			51.8			50.3			48.6			43.3			30
32	50			48.4			46.9			45.3			42.8			32
34	46.9			45.3			43.9			42.4			41.3			34
36	44			42.5			41.2			39.7			38.7			36
38	41.5	34.4		40			38.7			37.3			36.3			38
40	39.2	32.4		37.8	30.9		36.5			35.2			34.2			40
44	35.1	28.9		33.8	27.5		32.6	26.3		31.3			30.4			44
48	31.7	25.9		30.4	24.6		29.3	23.4		28.1	22.1		27.2	21.3		48
52	28.4	23.3		27.5	22.1		26.5	21		25.3	19.7		24.5	18.9		52
56		20.9	16.5	24.9	19.9		24	18.8		22.8	17.6		22.1	16.9		56
60		18.7	14.7	22.3	18	13.6	21.8	17	12.5	20.7	15.8		20	15.1		60
64		16.7	13		16.1	12.1	19.7	15.3	11.1	18.8	14.2	9.9	18.1	13.5		64
68			11.5		14.4	10.8		13.8	9.9	17.1	12.7	8.7	16	12	8	68
72			10.1			9.5		12.3	8.7	15.4	11.4	7.6	13.9	10.8	6.9	72
76						8.3			7.7		10.3	6.6	12.1	9.6	5.9	76
80									6.7		9.1	5.7		8.6	5	80
84											4.9			7.6	4.2	84
88											4.1				3.5	88
92															2.8	92

Unit:t

Load Chart of LJ

Load chart-LJ 4/6 (Jib 21-75m,Rear counterweight 150t,Carbody counterweight 40t)																
Boom 54m																
Jib	21			27			33			39			45			Jib
Angle	85°	75°	65°	85°	75°	65°	85°	75°	65°	85°	75°	65°	85°	75°	65°	Angle
14	126															14
16	112			108												16
18	100			97.1			93.8			91						18
20	90.5			87.8			84.9			82.4			79.8			20
22	82.5			80.1			77.5			75.2			72.8			22
24	75.8			73.6			71.2			69.1			66.9			24
26	70			68			65.7			63.8			61.8			26
28		54.5		63.1			61			59.2			57.4			28
30		50.7		58.9	49.1		56.9			55.2			53.4			30
32		47.3		55.2	45.8		53.2	44		51.6			50			32
34		44.2			42.9		50	41.2		48.5	39.8		46.8			34
36		41.5			40.3		47.1	38.7		45.6	37.3		44			36
38					37.9		44.5	36.4		43	35.1		41.5	33.6		38
40				30.1	35.8			34.3		40.7	33.1		39.2	31.6		40
44			26.2					30.7		36.6	29.6		35.2	28.2		44
48						22.7		27.1	21.9		26.6		31.9	25.3		48
52									19.3		23.8	18.7		22.8	17.3	52
56									17.1			16.6		20.6	15.5	56
60												14.7			13.9	60
64															12.3	64
68															10.9	68

Jib	51			57			63			69			75			Jib
Angle	85°	75°	65°	85°	75°	65°	85°	75°	65°	85°	75°	65°	85°	75°	65°	Angle
22	70.7															22
24	65			62.9												24
26	60			58.1			56.1			47.5						26
28	55.7			53.9			52.2			47.1			40			28
30	51.8			50.1			48.6			46.6			39.6			30
32	48.4			46.8			45.4			43.8			39.2			32
34	45.4			43.9			42.5			41			38.7			34
36	42.7			41.2			39.9			38.4			37.3			36
38	40.2			38.8			37.5			36.1			35.1			38
40	38	30.3		36.6			35.3			34			33			40
44	34	27		32.7	25.6		31.5	24.4		30.3			29.4			44
48	30.7	24.2		29.5	22.8		28.3	21.7		27.1	20.4		26.3			48
52	27.9	21.7		26.7	20.5		25.6	19.4		24.4	18.1		23.6	17.3		52
56	25.2	19.6	14.4	24.2	18.4		23.2	17.4		22	16.2		21.3	15.4		56
60		17.8	12.9	22.1	16.6	11.6	21.1	15.6		20	14.4		19.2	13.7		60
64		16	11.5		15	10.3	19.2	14	9.3	18.1	12.9		17.4	12.2		64
68			10.3		13.6	9.1		12.6	8.1	16.5	11.5	7	15.8	10.8		68
72			9.1			8.1		11.4	7.1	15.1	10.3	6	14	9.6	5.2	72
76						7.1		10.2	6.2		9.2	5	12.4	8.5	4.3	76
80						6.2			5.3		8.2	4.2		7.5	3.5	80
84									4.5			3.4		6.6	2.8	84
88												2.7		5.8	2.1	88
92															1.4	92
96															0.8	96

Load Chart of LJ

Load chart-LJ 5/6
(Jib 21-75m,Rear counterweight 150t,Carbody counterweight 40t)

Boom 60m																
Jib	21			27			33			39			45			Jib
Angle	85°	75°	65°	85°	75°	65°	85°	75°	65°	85°	75°	65°	85°	75°	65°	Angle
14	115															14
16	107			104												16
18	96.3			93.3			90.2									18
20	87.1			84.6			81.8			79.3						20
22	79.5			77.2			74.7			72.5			70.2			22
24	73.1			71			68.7			66.7			64.5			24
26	67.6			65.6			63.5			61.6			59.6			26
28		51.1		61			58.9			57.2			55.4			28
30		47.5		56.9			55			53.4			51.6			30
32		44.3		53.4	42.9		51.5			49.9			48.3			32
34		41.5			40.2		48.3	38.5		46.9			45.3			34
36		38.9			37.7		45.5	36.1		44.1	34.8		42.6			36
38		36.6			35.5		43	34		41.6	32.7		40.2	31.1		38
40					33.5			32		39.4	30.8		37.9	29.3		40
44			24.2		30	23.1		28.6		35.5	27.5		34.1	26.1		44
48			21			20.6		25.8	19.3		24.7		30.8	23.4		48
52						18.3			17.3		22.3	16.2		21		52
56									15.5			14.5		19	13.2	56
60												13		17.2	11.7	60
64												11.6			10.5	64
68															9.3	68

Jib	51			57			63			69			75			Jib
Angle	85°	75°	65°	85°	75°	65°	85°	75°	65°	85°	75°	65°	85°	75°	65°	Angle
22	68.1															22
24	62.6			60.5												24
26	57.9			55.9			51.5									26
28	53.7			51.9			50.3			43.5			37.3			28
30	50			48.3			46.8			43			36.9			30
32	46.8			45.2			43.7			42.2			36.5			32
34	43.9			42.3			40.9			39.4			36.1			34
36	41.2			39.7			38.4			37			35.7			36
38	38.9			37.4			36.1			34.7			33.7			38
40	36.7			35.3			34.1			32.7			31.8			40
44	32.9	24.9		31.6	23.5		30.4			29.1			28.2			44
48	29.7	22.3		28.4	20.9		27.3	19.8		26.1	18.5		25.2			48
52	26.9	20		25.7	18.7		24.6	17.6		23.5	16.4		22.7	15.5		52
56	24.6	18		23.4	16.8		22.3	15.7		21.2	14.5		20.4	13.7		56
60		16.3	10.7	21.3	15.1		20.3	14.1		19.2	12.9		18.4	12.1		60
64		14.7	9.5		13.6	8.3	18.5	12.6		17.4	11.4		16.7	10.7		64
68			8.4		12.2	7.2	16.9	11.3	6.2	15.8	10.2		15.1	9.4		68
72			7.3		11	6.2		10.1	5.2	14.4	9	4.1	13.7	8.3	3.4	72
76			6.4			5.3		9	4.4		7.9	3.3	12.5	7.3	2.6	76
80						4.5			3.6		7	2.5	10.9	6.3	1.8	80
84									2.9		6.1	1.8		5.5	1.1	84
88									2.2			1.2		4.7	0.5	88
92												0.6				92

Unit:t

Load Chart of LJ

Load chart-LJ 6/6
(Jib 21-75m,Rear counterweight 150t,Carbody counterweight 40t)

Boom 66m																
Jib	21			27			33			39			45			Jib
Angle	85°	75°	65°	85°	75°	65°	85°	75°	65°	85°	75°	65°	85°	75°	65°	Angle
16	103			99.8												16
18	92.5			89.7			86.7									18
20	83.9			81.4			78.7			76.3						20
22	76.7			74.4			72			69.8			67.5			22
24	70.5			68.5			66.2			64.3			62.2			24
26	65.3			63.4			61.3			59.5			57.5			26
28	60.7			58.9			56.9			55.3			53.4			28
30		44.5		55			53.1			51.5			49.8			30
32		41.5		51.6	40.1		49.7			48.3			46.6			32
34		38.9		48.6	37.5		46.7			45.3			43.7			34
36		36.5			35.3		44	33.7		42.7			41.1			36
38		34.3			33.2		41.6	31.7		40.3	30.4		38.8			38
40					31.3			29.8		38.1	28.6		36.7	27.1		40
44			21.5		28			26.6		34.3	25.5		32.9	24.1		44
48			19.1			18.1		23.9			22.9		29.8	21.5		48
52						16.2			14.9		20.6			19.3		52
56						14.4			13.3		18.6	12.3		17.4		56
60									11.8			10.9		15.7	9.7	60
64												9.7			8.5	64
68												8.5			7.5	68
72															6.5	72

Jib	51			57			63			69			75			Jib
Angle	85°	75°	65°	85°	75°	65°	85°	75°	65°	85°	75°	65°	85°	75°	65°	Angle
24	60.3			53.1												24
26	55.7			52.3			45.4									26
28	51.8			50			44.8			38.5						28
30	48.3			46.6			44.1			38			32.8			30
32	45.1			43.5			42.1			37.5			32.4			32
34	42.3			40.8			39.4			37			32			34
36	39.8			38.3			37			35.6			31.6			36
38	37.5			36.1			34.8			33.4			31.1			38
40	35.4			34			32.8			31.5			30.5			40
44	31.8	22.9		30.4			29.3			28			27.1			44
48	28.6	20.4		27.4	19.1		26.3	18		25.1			24.2			48
52	26	18.3		24.8	17		23.7	15.9		22.5	14.6		21.7	13.8		52
56	23.7	16.4		22.5	15.2		21.5	14.1		20.3	12.9		19.6	12.1		56
60		14.8		20.5	13.6		19.5	12.6		18.4	11.4		17.6	10.6		60
64		13.3	7.5		12.2	6.3	17.7	11.2		16.6	10		15.9	9.3		64
68		12	6.5		10.9	5.3	16.2	9.9	4.3	15.1	8.8		14.4	8.1		68
72			5.6		9.7	4.4		8.8	3.5	13.7	7.7	2.3	13.1	7		72
76			4.7			3.6		7.8	2.7		6.7	1.5	11.8	6.1	0.8	76
80						2.9		6.9	2		5.8	0.9	10.7	5.2		80
84						2.2			1.3		5			4.4		84
88									0.7					3.6		88

Boom combination in LJDB

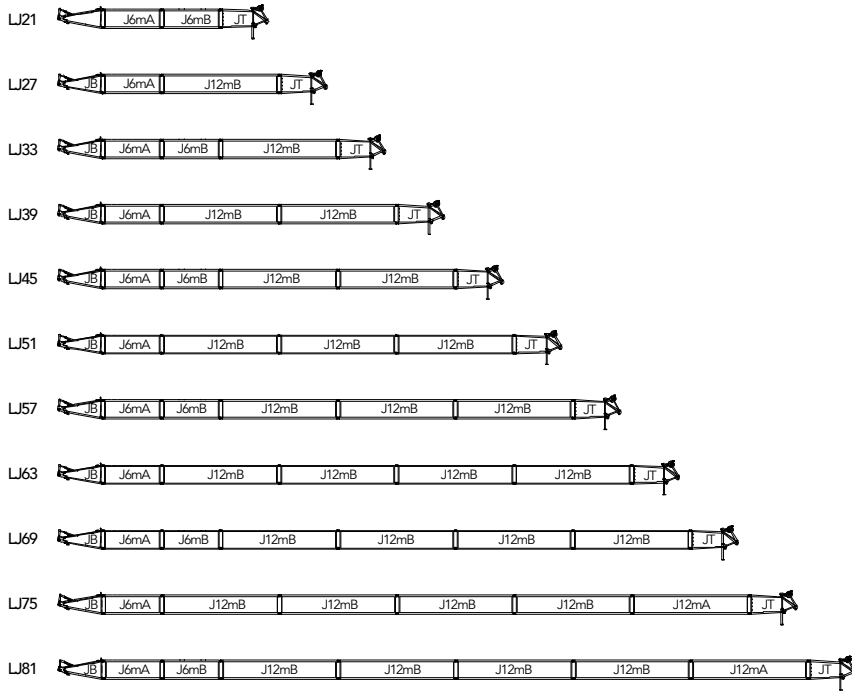

	Boom base
	Boom insert
	Boom insert
	Boom insert
	Tapered insert
	Boom tip
	Jib base
	Jib top
	Jib insert
	Jib insert
	Jib insert
	Jib insert

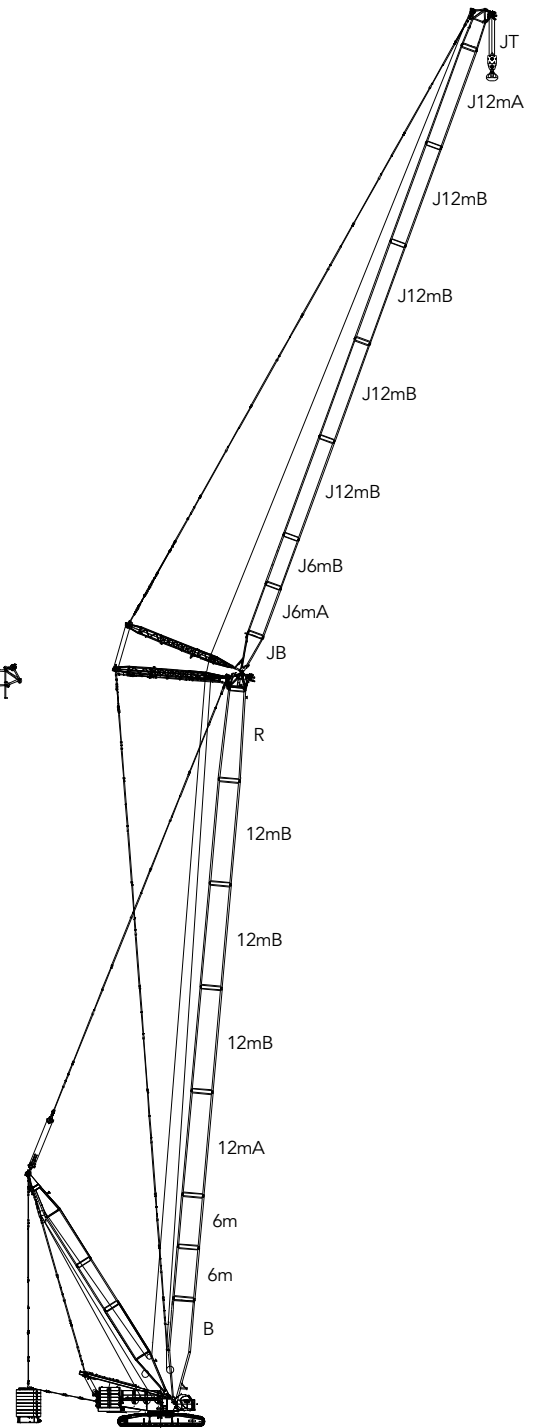

**LJDB Configuration
(36m~84m)+(21m~81m)**

Note: The 36m~84m boom combination is the same as that of the H Configuration.
For jib combination, the 4.5m jib base, 6m luffing jib insert A, and 4.5m jib top are must.

Working Radius in LJDB

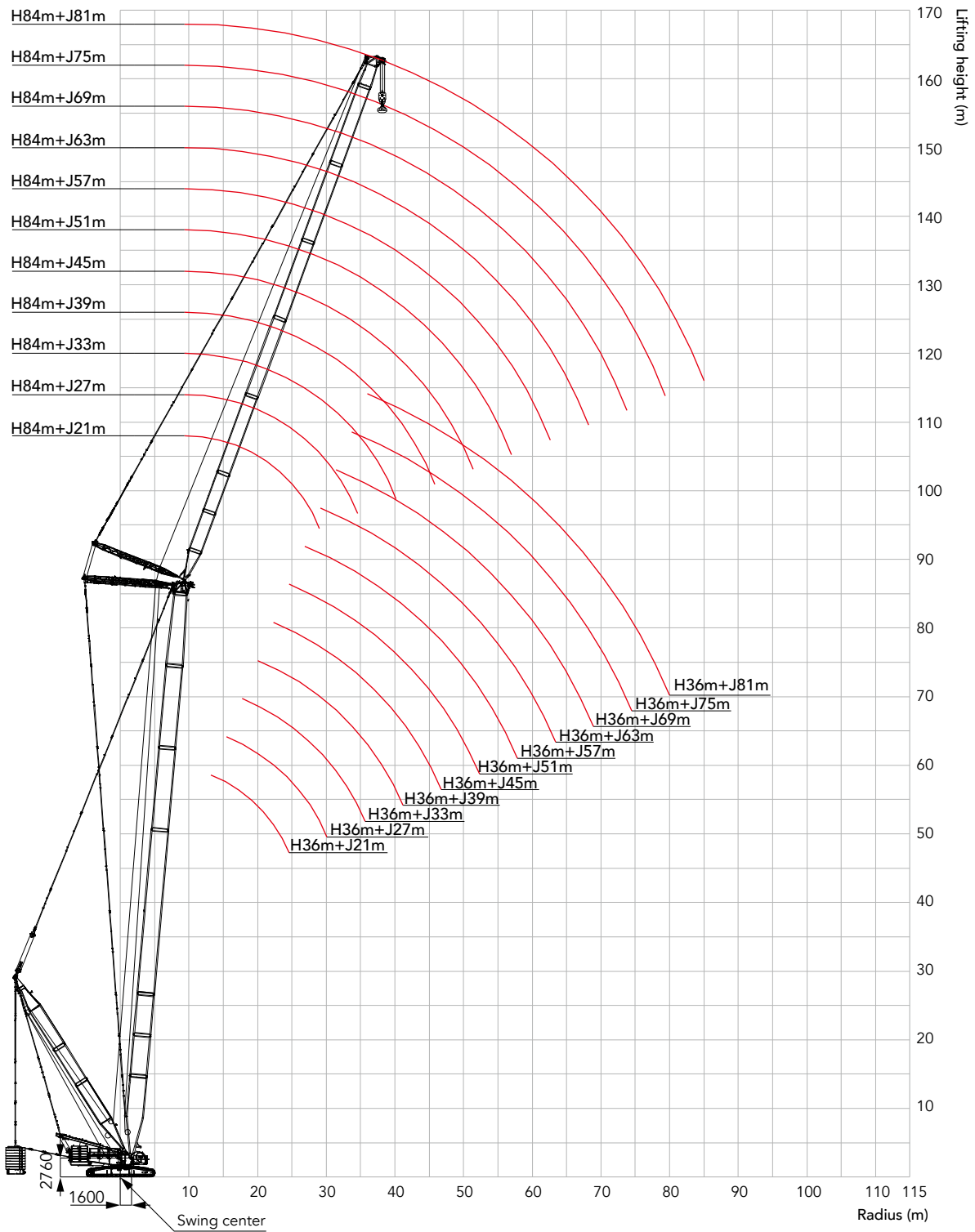

Load Chart of LJDB

Note:

- 1.The rated load in the load chart is calculated complying with EN13000;
- 2.The working radius is the horizontal distance from the load center to the swing center;
- 3.The actual lifting capacity must subtract the weight of hooks and other riggings from the rated capacity in the load chart;
- 4.The load value is calculated when the object is hung freely,without considering the influence of wind on the load, ground conditions and slope, operation speed and the influence of any other negative factors over safe operation. Therefore, the operator bears the responsibility of making a judgment and decreasing the load and lowering speed;
- 5.All ratings are calculated when the machine is parking on firm and level ground with less than 1% gradient;
- 6.See the Operation Manual for the complete load charts of LJDB Configuration.

Load chart-LJDB 1/4																
Boom length 36-84m,Jib length 21-81m,Superlift radius 15m, Superlift counterweight 0t,Rear counterweight 150t,Carbody counterweight 40t																
Boom 60m																
Jib	21			27			33			39			45			Jib
Angle	85°	75°	65°	85°	75°	65°	85°	75°	65°	85°	75°	65°	85°	75°	65°	Angle
14	117															14
16	100			99.9												16
18	87.3			86.8			85.8									18
20	76.9			76.5			75.6			74.9						20
22	68.5			68.2			67.3			66.7			65.8			22
24	71.8			71.6			70.8			70.2			69.3			24
26	65.1			65			64.2			63.6			62.8			26
28		49.6		59.4			58.7			58.1			57.3			28
30		45.6		54.5			53.9			53.3			52.6			30
32		42		50.2	41.3		49.7			49.2			48.4			32
34		45.6			45		53.1	44		52.6			51.9			34
36		42.4			41.9		49.4	40.9		49	40.1		48.3			36
38		39.4			39.1		46	38.2		45.7	37.4		45	36.3		38
40					36.5			35.7		42.8	34.9		42.1	33.9		40
44			26.6		32	25.8		31.4		37.7	30.7		37.1	29.7		44
48			23.3			22.8		27.8	21.8		27.2		32.9	26.3		48
52						20.2			19.3		24.2	18.5		23.3		52
56									17.1			16.4		20.8	15.3	56
60												14.6		18.5	13.5	60
64												6.3			5.3	64
68															4.3	68

Unit:t

Load Chart of LJDB

Load chart-LJDB 2/4																			
Boom length 36-84m,Jib length 21-81m,Superlift radius 15m, Superlift counterweight 0t,Rear counterweight 150t,Carbody counterweight 40t																			
Boom 60m																			
Jib	51			57			63			69			75			81			Jib
Angle	85°	75°	65°	85°	75°	65°	85°	75°	65°	85°	75°	65°	85°	75°	65°	85°	75°	65°	Angle
22	65.2																		22
24	68.6			65.1															24
26	62.2			61.3			54.9												26
28	56.6			55.8			54.6			46			38.9						28
30	51.9			51.1			50.4			45.8			38.7			32.6			30
32	47.8			47			46.3			45.4			38.4			32.3			32
34	51.3			49.9			48.4			45.1			38.1			32			34
36	47.6			46.8			45.5			44			37.9			31.7			36
38	44.4			43.6			42.9			41.4			37.6			31.4			38
40	41.5			40.8			40.1			39			37.2			31.1			40
44	36.6	28.9		35.8	27.9		35.1			34.3			33.9			30.5			44
48	32.4	25.5		31.7	24.5		31	23.7		30.3	22.6		29.8			28			48
52	28.9	22.6		28.2	21.6		27.6	20.8		26.8	19.8		26.4	19.2		24.5			52
56	25.8	20.1		25.2	19.2		24.6	18.4		23.8	17.4		23.4	16.8		21.3	15.9		56
60		17.9	12.7	22.6	17		22	16.3		21.3	15.3		20.9	14.8		18.5	13.8		60
64		9	4.5		8.1	3.5	12.4	7.4		11.7	6.5		11.3	5.9		10.5	5		64
68			3.6		6.9	2.5	10.8	6.2	1.7	10.1	5.3		9.8	4.7		9	3.8		68
72			2.7		5.7	1.7		5.1	0.9	8.7	4.2		8.4	3.7		7.7	2.8		72
76			1.8			0.9		4			3.2		7.1	2.7		6.4	1.8		76
80											2.3		6	1.9		5.3	1		80
84											1.5			1.1		4.3			84
88														0.3					88

Load Chart of LJDB

Load chart-LJDB 3/4																
Boom length 36-84m,Jib length 21-81m,Superlift radius 15m, Superlift counterweight 0t,Rear counterweight 150t,Carbody counterweight 40t																
Boom 66m																
Jib	21			27			33			39			45			Jib
Angle	85°	75°	65°	85°	75°	65°	85°	75°	65°	85°	75°	65°	85°	75°	65°	Angle
16	99.4			98.8												16
18	86.3			85.8			84.8									18
20	76.1			75.6			74.7			74						20
22	67.8			67.4			66.5			65.9			65			22
24	60.9			60.6			59.8			59.2			58.3			24
26	64.5			64.3			63.6			63			62.1			26
28	58.7			58.8			58			57.5			56.7			28
30		43.7		54			53.3			52.8			52			30
32		40.3		49.7	39.5		49.2			48.6			47.9			32
34		37.3		45.9	36.6		45.5			45			44.3			34
36		41			40.3		48.9	39.3		48.5			47.8			36
38		38.1			37.6		45.6	36.7		45.3	35.8		44.6			38
40					35.2			34.3		42.4	33.5		41.7	32.4		40
44			24.6		30.9			30.1		37.3	29.4		36.7	28.4		44
48			21.7			20.9		26.7			26		32.6	25		48
52						18.5			17.5		23.1			22.2		52
56						16.3			15.5		20.6	14.7		19.8		56
60									13.7			13		17.6	11.9	60
64												11.5			10.4	64
68												3.8			2.9	68
72															2.1	72

Unit:t

Load Chart of LJDB

Load chart-LJDB 4/4																			
Boom length 36-84m,Jib length 21-81m,Superlift radius 15m, Superlift counterweight 0t,Rear counterweight 150t,Carbody counterweight 40t																			
Boom 84m																			
Jib	51			57			63			69			75			81			Jib
Angle	85°	75°	65°	85°	75°	65°	85°	75°	65°	85°	75°	65°	85°	75°	65°	85°	75°	65°	Angle
24	57.6			56.7															24
26	61.4			58.2			49.5												26
28	56			55.1			49.3			41.8									28
30	51.3			50.4			49			41.6			35.4			29.8			30
32	47.2			46.4			45.7			41.3			35.2			29.6			32
34	43.6			42.8			42.1			41.1			34.9			29.3			34
36	47.1			45.5			44.1			40.7			34.7			29.1			36
38	43.9			42.9			41.6			40.1			34.4			28.9			38
40	41.1			40.3			39.3			37.8			34.1			28.7			40
44	36.1	27.5		35.4			34.7			33.8			32.9			28.1			44
48	32	24.2		31.3	23.2		30.6	22.3		29.8			29.4			27.5			48
52	28.6	21.4		27.8	20.4		27.2	19.6		26.4	18.6		26	18		24.7			52
56	25.5	19		24.9	18.1		24.3	17.3		23.5	16.2		23.1	15.7		21.6	14.6		56
60		16.9		22.3	16		21.7	15.2		21	14.2		20.6	13.7		18.6	12.7		60
64		15.1	9.6		14.2	8.4	19.5	13.4		18.7	12.5		18.3	11.9		16.2	11		64
68		6.8	2.1		6	1	10.5	5.2		9.9	4.3		9.5	3.8		8.7	2.8		68
72			1.3		4.9	0.3		4.2		8.5	3.3		8.1	2.8		7.4	1.8		72
76			0.6					3.2			2.4		6.9	1.9		6.2	1		76
80								2.3			1.5		5.7	1.1		5.1			80
84											0.7			0.3		4.1			84

Load Chart of LJDB

Note:

- 1.The rated load in the load chart is calculated complying with EN13000;
- 2.The working radius is the horizontal distance from the load center to the swing center;
- 3.The actual lifting capacity must subtract the weight of hooks and other riggings from the rated capacity in the load chart;
- 4.The load value is calculated when the object is hung freely,without considering the influence of wind on the load, ground conditions and slope, operation speed and the influence of any other negative factors over safe operation. Therefore, the operator bears the responsibility of making a judgment and decreasing the load and lowering speed;
- 5.All ratings are calculated when the machine is parking on firm and level ground with less than 1% gradient;
- 6.See the Operation Manual for the complete load charts of LJDB Configuration.

Load chart-LJDB 1/4 Boom length 36-84m,Jib length 21-81m,Superlift radius 15m,Superlift counterweight 50t, Rear counterweight 150t,Carbody counterweight 40t																
Boom 78m																
Jib	21			27			33			39			45			Jib
Angle	85°	75°	65°	85°	75°	65°	85°	75°	65°	85°	75°	65°	85°	75°	65°	Angle
16																16
18	113															18
20	109			97.4												20
22	105			94.6			83.6									22
24	99.3			91.6			81.6			72.2						24
26	90.4			88.6			79.4			70.7			62.2			26
28	82.8			82.6			77.1			69.1			61.1			28
30				83			74.9			67.5			60			30
32				78.1			72.7			65.8			58.7			32
34		61.1		72.6			69.6			64.1			57.5			34
36		57.1					65.4			61.8			56.2			36
38		53.5			52.7		61.9			58.6			54.9			38
40		50.2			49.6		58.8	48.5		55.2			52.2			40
44					49.2			47.9		49.6	46.7		47.1			44
48					44.1			43.3			42.1		42.4	40.7		48
52			33					39.1			38.3		38.4	36.9		52
56						29.2					34.9			33.6		56
60						26.5			25.6		31.7			30.8		60
64									23.3				22.5			64
68													20.5		19.4	68
72													18.7		17.7	72
76															16.2	76
80																80

Unit:t

Load Chart of LJDB

Load chart-LJDB 2/4																			
Boom length 36-84m,Jib length 21-81m,Superlift radius 15m,Superlift counterweight 50t, Rear counterweight 150t,Carbody counterweight 40t																			
Boom 78m																			
Jib	51			57			63			69			75			81			Jib
Angle	85°	75°	65°	85°	75°	65°	85°	75°	65°	85°	75°	65°	85°	75°	65°	85°	75°	65°	Angle
24																			24
26																			26
28	53.6																		28
30	52.9			46.2															30
32	52			45.6			39.6												32
34	51.1			45			39.1			33.7									34
36	50.2			44.3			38.7			33.4			28.7						36
38	49.4			43.6			38.2			33			28.5			24.1			38
40	48.4			42.9			37.7			32.6			28.2			23.9			40
44	44.7			41.4			36.6			31.8			27.6			23.4			44
48	40.5			38.4			35.4			31			26.9			22.8			48
52	36.5	35.6		34.9	34.2		33			30.1			26.2			22.3			52
56	33	32.5		31.6	31		30.1	29.8		28.7			25.5			21.7			56
60		29.7		28.8	28.3		27.6	27.1		26.3	25.7		22.8			19.2			60
64		27.3		26.4	26		25.2	24.8		24	23.4		20.1	22.4		16.6	21		64
68		25.1			23.9		23.2	22.7		22.1	21.4		17.5	20.4		14.2	19		68
72			16.8		22			20.9		20.3	19.6		15.2	18.7		12.1	17.3		72
76			15.3		20.3	14.1		19.3			18		13.4	17.1		10.2	15.8		76
80			8.7			7.7		12.3	6.8		11.4		11.7	10.9		8.5	9.9		80
84			7.7			6.7			5.9		10.2	4.8		9.7		7	8.8		84
88						5.8			5		9.1	3.9		8.6	3.3		7.7		88
92														7.6	2.6		6.7	1.5	92
96																	5.8	0.9	96
100																	4.9		100
104																	0.7		104
108																			108

Load Chart of LJDB

Load chart-LJDB 3/4																
Boom length 36-84m,Jib length 21-81m,Superlift radius 15m,Superlift counterweight 50t, Rear counterweight 150t,Carbody counterweight 40t																
Boom 84m																
Jib	21			27			33			39			45			Jib
Angle	85°	75°	65°	85°	75°	65°	85°	75°	65°	85°	75°	65°	85°	75°	65°	Angle
16																16
18	100															18
20	97.1			86.6												20
22	93.6			84			74.6									22
24	90.2			81.4			72.7			64.6						24
26	87			78.7			70.7			63.2			55.9			26
28	82			76.1			68.6			61.7			54.9			28
30				73.6			66.6			60.1			53.7			30
32				71.4			64.6			58.5			52.6			32
34				69.4			62.7			57			51.4			34
36		55.1					60.9			55.4			50.1			36
38		51.6					57.7			53.9			48.9			38
40		48.5			47.7		54.7			51.4			47.7			40
44		42.9			42.4			41.4		46.2			43.8			44
48					42.6			41.3			40.1		39.4	38.6		48
52								37.5			36.4		35.6	35		52
56			27.8			27		34.1			33.2			31.9		56
60						24.6			23.5		30.4			29.1		60
64						22.3			21.4			20.5		26.7		64
68									19.5			18.7			17.4	68
72												17.1			15.9	72
76															14.5	76
80															13.2	80
84																84

Unit:t

Load Chart of LJDB

Load chart-LJDB 4/4																			
Boom length 36-84m,Jib length 21-81m,Superlift radius 15m,Superlift counterweight 50t, Rear counterweight 150t,Carbody counterweight 40t																			
Boom 84m																			
Jib	51			57			63			69			75			81			Jib
Angle	85°	75°	65°	85°	75°	65°	85°	75°	65°	85°	75°	65°	85°	75°	65°	85°	75°	65°	Angle
24																			24
26																			26
28	48.4																		28
30	47.6			41.6															30
32	46.8			41.1			35.9												32
34	45.9			40.4			35.4												34
36	45			39.8			34.9			30.2									36
38	44			39.1			34.4			29.8			25.9						38
40	43.1			38.3			33.9			29.4			25.6			21.7			40
44	41.2			36.9			32.8			28.6			24.9			21.1			44
48	37.5			35.5			31.6			27.7			24.3			20.6			48
52	33.8	33.7		32.4			30.4			26.8			23.5			20.1			52
56	31	30.6		29.3	29.2		27.9			25.9			22.8			19.5			56
60		28		26.9	26.6		25.6	25.3		24.3	23.8		22.1			18.9			60
64		25.7		24.6	24.3		23.4	23.1		22.2	21.7		20.3	20.6		16.8			64
68		23.6			22.3		21.4	21.2		20.4	19.8		17.6	18.8		14.3	17.3		68
72		21.7	14.8		20.5			19.4		18.8	18.1		15.5	17.1		12.3	15.7		72
76			13.5		18.9	12.1		17.9		17.4	16.6		13.6	15.6		10.3	14.3		76
80			12.3			11		16.5	9.9		15.2		11.8	14.3		8.6	13		80
84			11.2			10		15.2	8.9		14	7.5		13.1		7.2	11.8		84
88						4.4			3.5		8.2	2.4		7.7	1.8		6.8		88
92						3.6			2.8			1.7		6.7	1.1		5.8		92
96									2.1			1.1		5.8	0.5		4.9		96
100												0.5					4.1		100
104																			104
108																			108



Zhejiang Sany Equipment Co.,LTD

SANY Crawler Crane Industrial Park, No. 2188 Daishan Road, Wuxing District, Huzhou City, Zhejiang Province, P. R. China Zip 313028

Consulting sanycrane@sanygroup.com (Crane BU) / crd@sany.com.cn (IHQ)

After-sales Service 0086-400 6098 318

Reminder:

Any change in the technical parameters and configuration due to product modification or upgrade may occur without prior notice. The machine in the picture may include additional equipment. This brochure is for reference only, and goods in kind shall prevail.

Copyright at SANY. No part of this brochure may be copied or used for any purpose without written approval from SANY.

© Edited in April 2022

