



# SCE4800A

## SANY Crawler Crane

### 480 Tons Lifting Capacity

Quality Changes the World



**Max. lifting moment: 6006t·m**

**Longest boom: 84m**

**Longest boom +jib: 84m + 84m**

The parameters, pictures and standard/optional equipment are only for reference in this brochure, the actual machine is based on the effective price list and contract.

■ [www.sanyglobal.com](http://www.sanyglobal.com)



## Crawler Crane Series SCE4800A

P03

Main  
Characteristics

- Product Specification
- Safety Devices

P09

Technical  
Parameters

- Major Performance & Specifications
- Outline Dimension
- Transport Dimensions
- Transport Plan
- Self-Assembly Plan

P27

Configurations

- HJFJ-2 Configuration
- HJFJDB-5 Configuration
- H Configuration
- HDB Configuration
- HJ Configuration
- HJDB Configuration
- LJ(DB) Configuration



**SCE4800A**  
**SANY CRAWLER CRANE**  
**480 TONS LIFTING CAPACITY**

QUALITY CHANGES THE WORLD

## Main Characteristics

- Page 04 Product Specification
- Page 07 Safety Devices



## Product Specification



### Engine

- Model: Cummins Diesel engine (European Tier V Emission Standard);
- Type: water-cooled, vertical in-line 6 cylinders, direct injection, turbo-charger, intercooler, complied with European Off-highway Tier V Emission Standard;
- Displacement: 11.8L;
- Rated power: 298kW/2100rpm;
- Operation power: 336kW/1800rpm;
- Max. Torque: 2169N·m/1400rpm;
- Starter: 24V-7.5kW;
- Radiator: fin type aluminum plate core;
- Air cleaner: Dry type system with main filter element, safety element and resistance indicator;
- Throttle: Grip type hand throttle, electrically-controlled;
- Fuel filter: Replaceable paper element;
- Batteries: Four 12V×180Ah capacity batteries, connected in series and then in parallel;
- Fuel tank capacity: 800L.

### Electrical Control System

- Self-developed SYMC integrated control system is adopted with higher integration, precise operation and reliable quality;
- Control system consists of power system, engine system, main control system, LMI system, auxiliary system and safety monitoring system;
- Main electrical components are from internationally or industrially well-known brands, and they can perform stably in such bad environment as in severe low or high temperature, plateau, and sandstorms. The design with multi-stage safety limits and kinds of safety signal indicators, totally complies with CE Standard;
- LMI, combined monitors and closed circuit monitor are directly visible to operator. LMI detects the lifting moment and other status; combined monitors display operation conditions, limited status under control and alarms; closed circuit monitor monitors working conditions of the winch and rear parts. For armrest boxes at both sides, there are three operation levers, and the button switches the control functions, so the function elected and respective operating range of the lever will appear on the monitors;

### Hydraulic System

- Main pumps: five close piston pumps of electronic proportion are adopted to provide oil supply for main actuators of main machine;
- Assisting pump: electronic proportion open piston pump, providing oil for assisting cylinder;
- Back-stop pump: load-sensitive feedback pump, providing oil for back-stop system;
- Gear pump: two dual-gear pumps for oil-boosting system, oil radiator, A/C control circuit;
- Control: closed main pump adopts electronically controlled system, and the electronic lever controls the closed the pump and variable-placement motor;
- Rated pressure of main system: 35MPa;
- Oil boosting system: 3.5 MPa;
- Hydraulic Tank Capacity: 817L;
- Components: hydraulic system of load hoisting, traveling, swing, hoisting and luffing, servo, anti-backstop, cooling, aux. system. Main components are all imported originally;
- Features: Closed circuit is adopted for all load hoisting hydraulic, traveling hydraulic, hoisting and luffing hydraulic and swing hydraulic system, featured by saving energy, high-efficiency, fast-reaction, low heat emission, and long service life;
- Servo hydraulic system adopts electronic proportion controlled components for accurate and smart control;
- Backstop hydraulic system adopts external-controlled releasing balance valve on the hydraulic, safety and reliable;
- Cooling system is featured with high radiating power and excellent cooling result.

### Cab

- Fully-enclosed steel frame structure and large area of glass window at front, sides and top make brightened cab with broaden view. The floating, damping and de-noising, and multi-stage adjusted seat, and air conditioner enable better operating experience. There are control lever, control button and ignition lock fitted in the right and left armrest box and assisting control box. The low noise (less than 85dB), the ergonomically designed seat and buttons realize more comfortable operation. The cab can tilt up from 0°~24° for broaden view and rotates to the front of the platform for convenient transport.

### Closed circuit camera system

- The camera system is fitted with two monitors and multi cameras, each monitor displaying four pictures at most, realizing real-time monitoring the rope rotating of the winch drum, lifting status of the superlifting counterweight and surrounding;
- The system is equipped with recording function, and longest reserving time can be up to 76 hours, providing reference to the operation and accident.





## Product Specification

### Main and Aux. Load Hoist Mechanism

- A variable hydraulic motor drives the planetary gear reducer to control the lifting and lowering of main hoists I and II. A good inching performance is provided. The highest speed can be realized through main hoist I and II. Synchronization function is designed. One hoist for load less than 225t, dual main hoists work at the same time for load exceeding 225t; When single rope pull of any main hoist is larger than 6t, the synchronization function acts, winching speed of out most layer reaches 140m/min, and the largest parts of line is 36. Multiple layers of wire rope on fold-line drum can avoid messing rope. The gearbox is quiet and efficient, with longer service life and convenient fuel change.

Main load hoist mechanism I	Drum diameter	666mm
	Rope speed on the outermost work layer	0~140m/min
	Steel rope diameter	26mm
	Steel rope length of main hoist	950m
	Rated tension of single rope	15.3t
Main load hoist mechanism II	Drum diameter	666mm
	Rope speed on the outermost work layer	0~140m/min
	Steel rope diameter	26mm
	Steel rope length of main hoist II	950m
	Rated tension of single rope	15.3t

### Boom/Jib/Superlift Hoist Mechanism

- Including: luffing mechanisms of the boom, jib and superlift;
- Drums with fold-line grooves are adopted for all luffing devices. Hydraulic motor drives the planetary gear reducer with excellent infinitely variable displacement to realize multi-functions.

Boom luffing mechanism	Drum diameter	641mm
	Rope speed on the outermost work layer	(0~70)×2m/min
	Steel rope diameter	26mm
	Steel rope length of boom luffing	560m
Jib luffing mechanism	Drum diameter	676mm
	Rope speed on the outermost work layer	0~110m/min
	Steel rope diameter	26mm
	Steel rope length of jib luffing	740m
Superlift mast luffing mechanism	Drum diameter	676mm
	Rope speed on the outermost work layer	0~110m/min
	Steel rope diameter	26mm
	Steel rope length of superlift luffing	840m

### Swing Mechanism

- Swing hydraulic system adopts dual motors and is driven by the the planetary reducer via gear. It can realize 360° swinging range, infinitely variable swing speed of 0~0.86r/min, and steady free flipping function, without shocking at start and stop.
- Swing ring: three-row roller external-engaged bearing.

### Carbody

- The hydraulic cylinder drives power pin to be connected with track frame to facilitate the assembly and disassembly. Frame structures are welded by high-strength steel. Larger chassis design greatly improves the stability of the crane;
- Carbody counterweight: Total weight:50t, each 25t at rear and front, including counterweight tray: 15t\*2, 10t standard counterweight block\*2.

### Crawler Assembly

- Track frame: each track frame is equipped with an independent travel driving device. A hydraulic travel motor drives the planetary gear reducer and realizes independent traveling through the transmission of driving wheel. There are 4-stage speeds: 0.33km/h, 0.55km/h, 0.77km/h, 1.00km/h. The travel system is configured with high and low speeds: sufficient traction is provided in low speed to to travel with 100% load, while faster job-site transfer is possible in high travel speed. Infinite variable speed can be realized in travel driving system;
- Track shoe: it is manufactured by advanced casting techniques and materials with high strength and good wear resistance. After assembled on the machine, the tension can be adjusted by a hydraulic jack with shims used to secure the crawler position.

### Operation Equipments

- All operation equipments adopt high-strength steel tubes and plates; the sheaves at boom tops and hooks are all made of milled welded steel.

## Product Specification



### Counterweight

- Counterweight include carbody counterweight, rear counterweight, superlift counterweight, and the details are listed below:

Name	Quantity	Length (m)	Width (m)	Height (m)	Unit Weight (t)
Carbody counterweight tray	2	2.99	2.94	1.06	15
Carbody counterweight block	2	2.85	2.4	0.48	10
Rear counterweight tray	2	3.18	2.83	1.8	10
Rear counterweight block	16	2.85	2.4	0.48	10
Superlift counterweight tray	1	8.6	2.5	1.83	10
Superlift counterweight block	20	2.85	2.4	0.48	10

### Operation Equipment

- All chords are high-strength steel tubes, and the boom/jib top sheaves are made of high-strength anti-wearing Nylon material protecting wire rope. The hooks are installed with milled welded steel sheave.

### Boom

- The boom is a spatial lattice structure with equal section areas for inserts and tapered section areas for both ends. With pipes welded together, and boom tip and root strengthened with steel plates, it can better transfer the load;
- The length of the boom ranges from that (24m) of the base boom to the maximum length (84m) and it can be increased progressively by 6m;
- Composition: boom base 12m×1, transitional insert 10.5m×1, connecting section (boom top) 1.5m×1, insert section 6m×2, and insert section 12m×4;
- Optional offers: 3m boom(for wind energy configuration without superlift, 60m power boom(12m\*5);
- The extension jib can install on the boom top.

### Fixed Jib

- The fixed jib is a spatial lattice structure with equal section areas for inserts and tapered section areas for both ends. With pipes welded together, and boom tip and root strengthened with steel plates, it can better transfer the load;
- The length of fixed jib is 12m, and with jib extension.

### Luffing Jib

- The luffing jib is a spatial lattice structure with equal section areas for inserts and tapered section areas for both ends. With pipes welded together, and boom tip and root strengthened with steel plates, it can better transfer the load;
- The length of the luffing jib ranges from 24m to 84m;
- Composition: jib base 10.5m×1, jib insert 6m×3, jib insert 12m×4, and jib top 7.5m×1;
- The extension jib can install on the jib top.

### Superlift Device

- The superlift mast is a spatial lattice structure with equal section areas for inserts and tapered section areas for both ends. With pipes welded together, and boom tip and root strengthened with steel plates, it can better transfer the load;
- The superlift mast is 30m long;
- Composition: mast base 12m×1, insert section 6m×1, and mast top 12m×1.

### Hook

- 6 kinds of hooks are available, and specific parameters are as follows:

Name of Hook	Max. Lifting Capacity	Quantity	Pulleys	Unit Weight (t)
450t hook	450t	1	2×9	10.9
240t hook	240t	1	2×4	6.8
160t hook	160t	1	2×3	3.8
130t hook	130t	1	5	3.06
50t hook	50t	1	2	2.4
16t ball hook	16t	1	-	0.9

Note: The 450t hook, 240t hook, and 160t hook can be respectively decomposed to 225t hook, 120t hook, 80t hook. For shield configuration, 200t hook of a single sheave is available.



## Safety Devices

### Operating Weight

- The operating weight is about 380t, including the Upperworks, lowerworks, rear counterweight of basic machine, carbody counterweight, 24m basic boom and 450t hook.

### Ground Bearing Pressure

- The average ground pressure of machine with basic boom is 0.175MPa.

### Gradeability

- The gradeability of machine with basic boom is 15%.

### Load Moment Limiter

- The proprietary load moment limiter independently -developed by Sany is adopted, which forms a network with other controllers through CAN bus line, so as to realize safe and reliable control. The load moment limiter can automatically detect the hoisting weight of the crane and the angle of the boom, and display the rated load capacity, actual load, working radius, and the allowable height of the hook;
- The load moment limiter system consists of a large-screen color display, a host computer, angle sensors, tension sensors, pressure sensors and other components.

### Over-hoist Protection of the Main and Auxiliary Hooks

- It is used to prevent the over-hoist of the hook. When the lifting hook is raised to a certain height, the limit switch will start working, and hook will be automatically cut off from moving up by the control system. Meanwhile, the display and the buzzer will give alarms. At this moment, only hook lowering is allowed to prevent over-hoist action.

### Over-release Protection Device of the Main and Auxiliary Hook

- It is used to prevent the wire rope over-release. When the wire rope is released to the last three wraps, the limit switch will start working, and the releasing of rope will be automatically stopped by the control system. Meanwhile, the display and the buzzer will give alarms. At this moment, only rope retraction is allowed to prevent over release action.

### Assembly/Work Mode Switchover

- In Assembly Mode, some of the safety devices cannot function properly, such as jib limit, boom angle limit in LML, and overload, so as to facilitate the crane assembly;
- In Work Mode, all safety devices can function properly.

### Boom Angle Limit

- When boom angle exceeding 85° and jib angle exceeding 75°, corresponding limit switch will be triggered, and the control system will automatically cut off the boom hoisting. Meanwhile, the display and the buzzer will give alarm. At this moment, boom/jib luffing winch won't hoist but it can still lower down;
- When the boom angle is less than 30° and jib angle less than 15°, the control system will automatically cut off the boom/jib from further lowering. Meanwhile, the display and the buzzer will give alarms. At this moment, boom/jib luffing winch won't be able to lower. This protection is automatically controlled by Load Moment Limiter.

### Back-stop Device

- The boom and the superlift mast are respectively equipped with a pair of back-stop cylinders. The high pressure of the cylinder shall be overcome when the boom tilts backwards, and high pressure oil will be supplemented automatically when the boom swings forwards to increase the tension and prevent the boom vibration and shaking back;
- The jib rear mast is equipped with a pair of back-stop cylinders, while the jib front mast is equipped with a pair of pneumatic cylinders to prevent the mast from the backward inclination and tension of the jib luffing wire rope.

### Brake of Hoisting Mechanism

- All hoisting brakes are spring loaded normally closed disc brakes, which are featured with large braking force, maintenance-free, safe and reliable use, and long service life.

### CCTV Monitoring System

- It can be used to monitor the winding conditions of wire ropes of each hoisting mechanism, the conditions of superlift weight, and conditions around the equipment.

## Safety Devices



### Fault Auto-Diagnosis System

- Faults can be conveniently eliminated based on the fault code.

### Black Box

- It is able to record the operation data and machine movement, and analyze the remaining running conditions and service life of machine based on the actual performance.

### Pharos

- It is mounted on the top of the boom/jib and alerts in air during night.

### Anemometer

- It is mounted on the top of the boom/jib to monitor the wind speed in real time and display relative data on the monitor.

### Electronic Level Indicator

- It displays the tilting angle of the crane on the monitor in real time and protects the safe operation of the crane.

### Lightning Protection Device

- It includes the lightning protection device and the surge protection device, which can effectively protect the electric system elements and workers from lightning.

### Hook Latch

- The lifting hook is installed with a baffle plate to prevent wire rope from falling off.

### Swing and Traveling Alarm

- During swing and traveling, the alarm horn will be blown per certain frequency to alert the personnel around the crane. The horn can be shut off through the display.

### Function Lock

- The operation will be locked by pulling up the function locking lever on the right side of the seat inside the driver's cab or when the operator left the seat, after which no operating handles will be working so that improper operation caused by the body collision when getting on and off the crane can be avoided.

### Regulation of Engine Power Ultimate Load and Stalling Protection

- The controller can monitor the engine power so as to prevent stalling.

### Engine Status Monitoring

- It can show the engine coolant temperature, fuel volume, total working hours, engine oil pressure, engine speed, battery and voltage.

### Remote Monitoring System

- It monitors and analyzes the operation data so as to realize remote diagnosis of faults and timely solution.

### Emergent Stop

- In a sudden loss of control, press the emergent stop, and brakes will be applied on all actions such as hoisting, luffing, swing and traveling and engine stop.



**SCE4800A**  
**SANY CRAWLER CRANE**  
**480 TONS LIFTING CAPACITY**

QUALITY CHANGES THE WORLD

## Technical Parameters

- Page 10 Major Performance & Specifications
- Page 11 Outline Dimension
- Page 14 Transport Dimensions
- Page 21 Transport Plan
- Page 26 Self-Assembly Plan



## Major Performance & Specifications

Major Performance & Specifications of SCE4800A		
Performance Indicators	Unit	Parameter
Max. rated lifting capacity	t	480
Max. rated lifting capacity (with superlift)	t	480
Max. rated lifting moment	t·m	2984
Max. rated lifting moment (with superlift)	t·m	6006
Boom length	m	24~84
Boom length (with superlift)	m	36~84
Length of mixed boom	m	48~96
Length of mixed boom (with superlift)	m	78~126
Length of luffing jib	m	24~72
Length of luffing jib (with superlift)	m	24~84
Combination of longest boom+jib (LJDB Configuration)	m	84+84
Mixed power boom +fixed jib	m	96+12
Mixed power boom+ fixed jib( with superlift)	m	126+12
Boom luffing angle	°	30~85
Jib luffing angle	°	25~75
Max. speed of single rope of the main hoist (outermost work layer)	m/min	0~140
Max. speed of single rope of the aux. hoist (outermost work layer)	m/min	0~140
Max. speed of single rope of the boom luffing (outermost work layer)	m/min	(0~70)×2
Max. speed of single rope of the jib luffing (outermost work layer)	m/min	0~110
Max. speed of single rope of the superlift luffing (outermost work layer)	m/min	0~110
Slewing speed (no load)	r/min	0~0.86
Travel speed	km/h	0~1(adjustable 4 stages)
Gradeability (with base boom, driver's cab backwards)	%	15
Rated output power of the engine	kW/r/min	298/2100
Average ground pressure of the track (boom base, 180t machine counterweight, 50t carbody counterweight)	MPa	0.175
Rear counterweight	t	180(without superlift)/ 140(with superlift)
Superlift counterweight	t	250
Carbody counterweight	t	50
Max. unit transportation dimensions (L × W × H)	mm	12100×3000×3200
Max. unit transportation weight	t	46

Unit: mm

**Outline Dimension**

**Two-Drive**

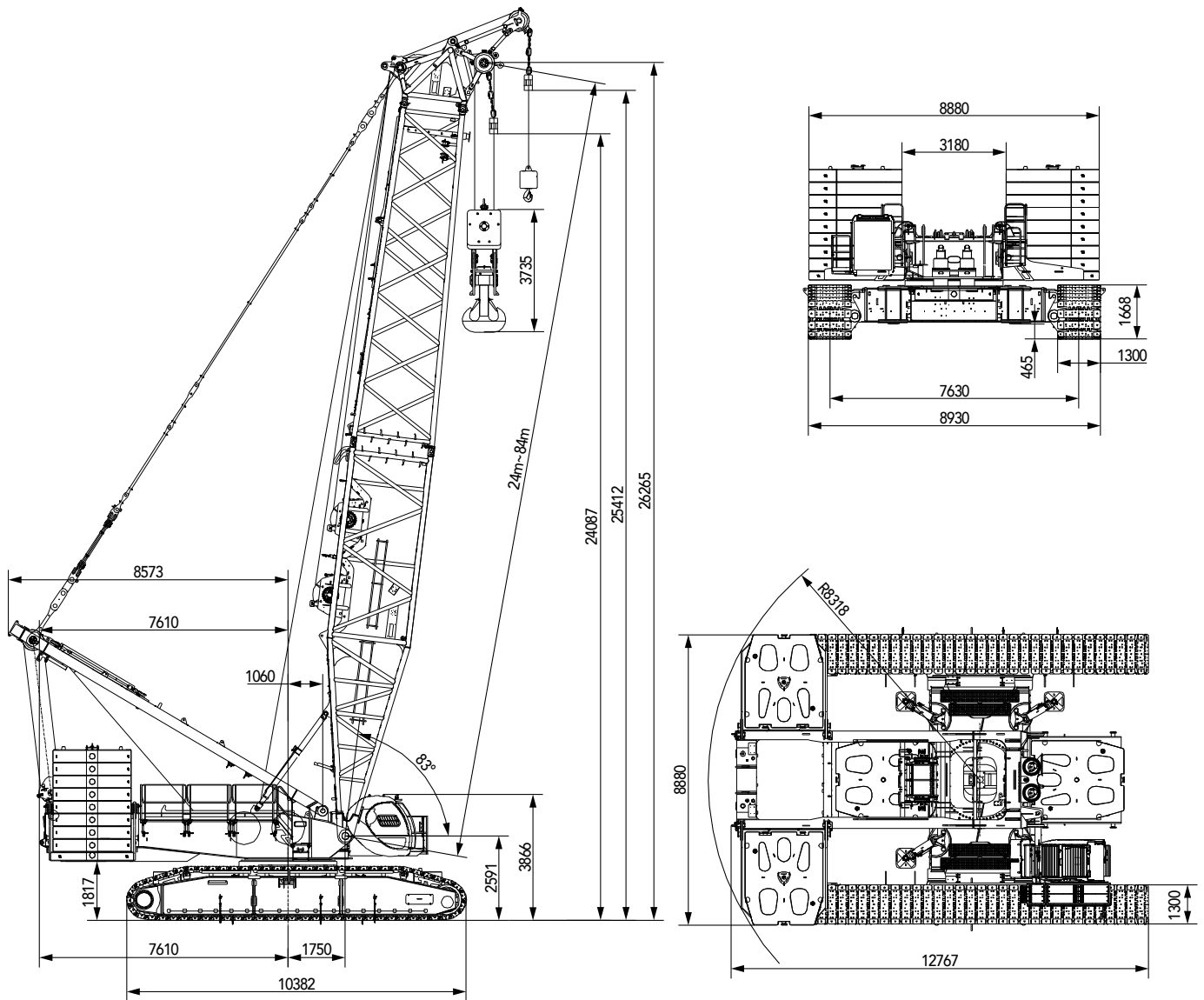





Unit: mm

## Outline Dimension

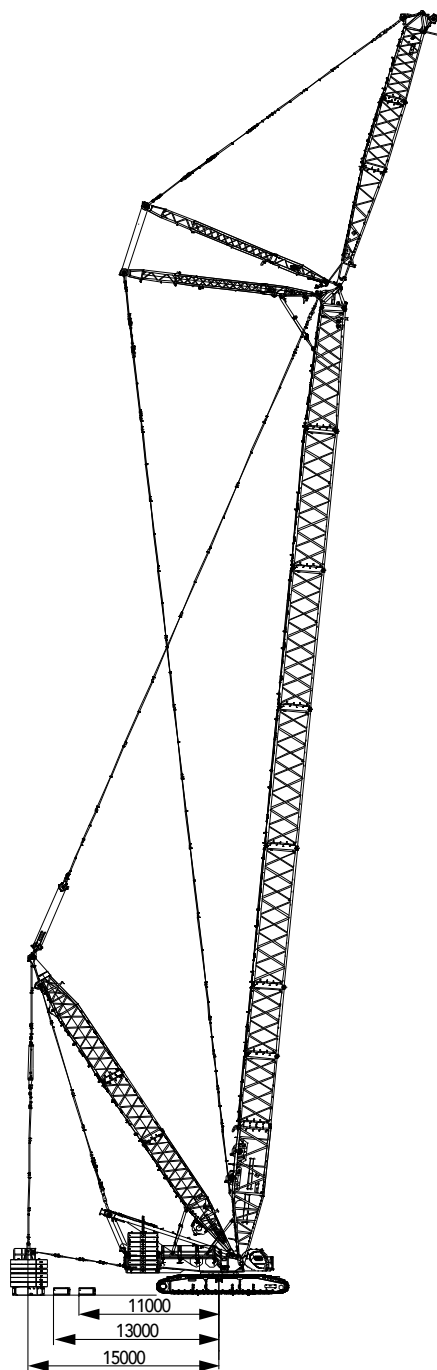

## Transport Dimensions

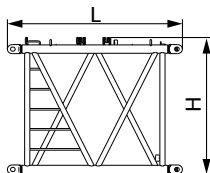
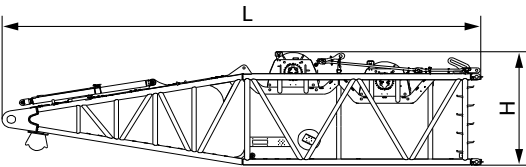
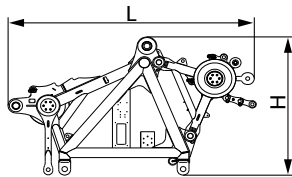
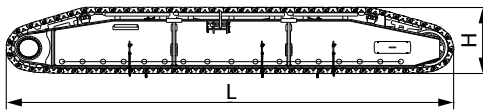
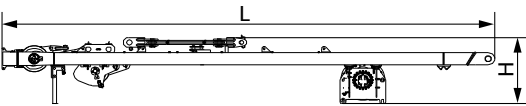
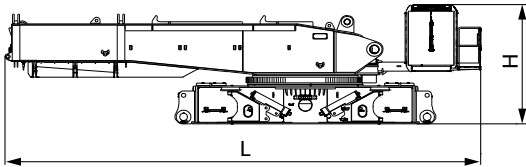

Basic machine	×1
Length(L)	12.10m
Width(W)	3.00m
Height(H)	3.20m
Weight	46.0t

Main hoisting mast (with winch)	×1
Length (L)	11.20m
Width (W)	2.60m
Height (H)	1.68m
Weight	12.11t

Crawler assembly	×2
Length(L)	10.38m
Width(W)	1.80m
Height(H)	1.67m
Weight	30.50t

Boom top (with pulley blocks)	×1
Length(L)	3.74m
Width(W)	2.78m
Height(H)	2.29m
Weight	5.24t

Boom base (with two hoisting winches)	×1
Length(L)	12.34m
Width(W)	3.00m
Height(H)	3.20m
Weight	22.40t

3m boom insert	×1
Length(L)	3.20m
Width(W)	2.98m
Height(H)	2.72m
Weight	1.35t

## Transport Dimensions

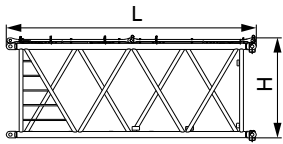

6m boom insert	×2
Length(L)	6.20m
Width(W)	3.00m
Height(H)	2.77m
Weight	3.24t

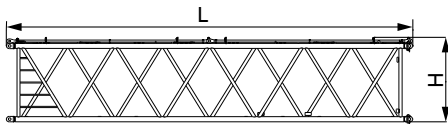

12m boom insert A	×4
Length(L)	12.24m
Width(W)	3.00m
Height(H)	2.80m
Weight	5.75t

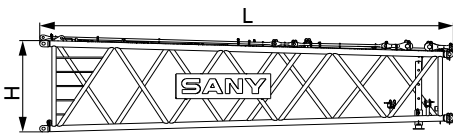

Boom tapered insert	×1
Length(L)	10.70m
Width(W)	2.98m
Height(H)	2.74m
Weight	6.03t

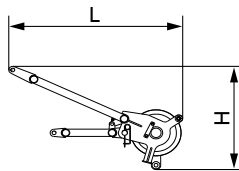

Boom extension	×1
Length(L)	2.32m
Width(W)	1.00m
Height(H)	0.818m
Weight	0.37t

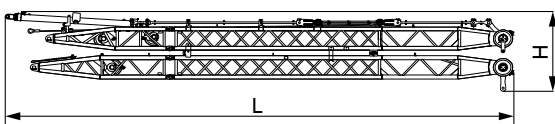

Front and rear mast of luffing jib	×1
Length(L)	16.80m
Width(W)	3.10m
Height(H)	2.78m
Weight	10.80t

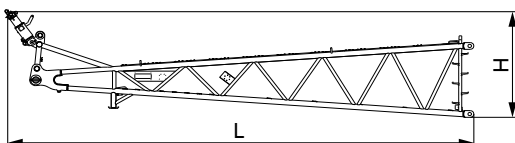

Luffing jib base	×1
Length (L)	11.20m
Width (W)	2.62m
Height (H)	2.78m
Weight	3.90t

## Transport Dimensions

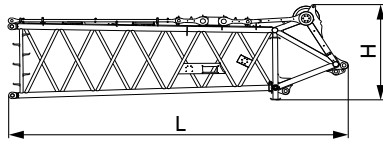

### Luffing jib top ×1

Length(L)	8.13m
Width(W)	2.54m
Height(H)	2.48m
Weight	4.34t

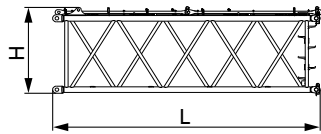

### 6m luffing jib insert A ×1

Length(L)	6.19m
Width(W)	2.82m
Height(H)	2.17m
Weight	1.97t

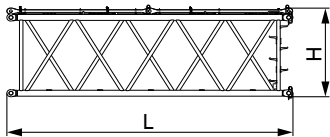

### 6m luffing jib insert B ×2

Length(L)	6.18m
Width(W)	2.82m
Height(H)	2.11m
Weight	1.91t

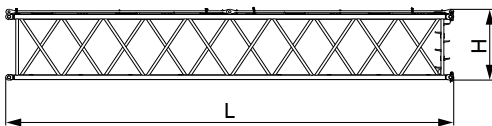

### 12m luffing jib insert ×4

Length(L)	12.20m
Width(W)	2.82m
Height(H)	2.11m
Weight	3.31t

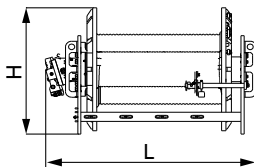

### Luffing mechanism ×1

Length(L)	1.72m
Width(W)	1.22m
Height(H)	1.13m
Weight	4.82t

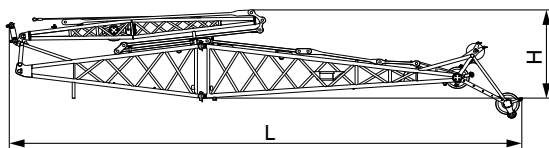

### Fixed jib assembly ×1

Length(L)	14.00m
Width(W)	2.40m
Height(H)	3.25m
Weight	5.28t

## Transport Dimensions

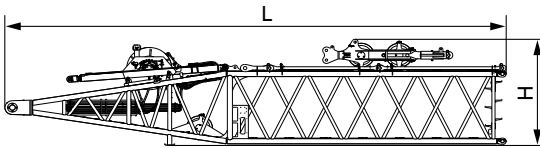

### Superlift mast base (with winch) ×1

Length(L)	12.30m
Width(W)	2.96m
Height(H)	2.84m
Weight	13.90t

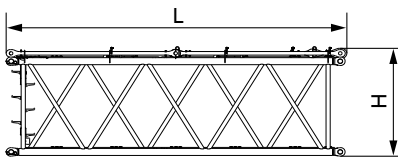

### Superlift mast insert (with winch) ×1

Length (L)	6.21m
Width (W)	2.96m
Height (H)	2.14m
Weight	2.90t

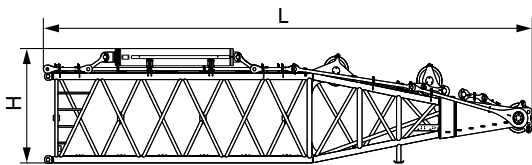

### Superlift mast top (with winch) ×1

Length(L)	12.40m
Width(W)	2.96m
Height(H)	2.40m
Weight	9.24t

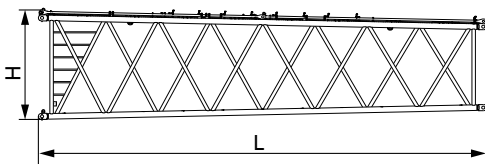

### 12m power boom base ×1

Length(L)	12.20m
Width(W)	3.56m
Height(H)	3.25m
Weight	6.98t

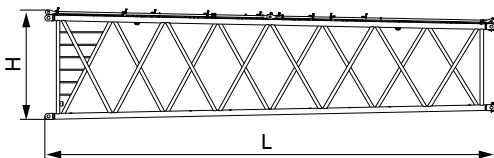

### 12m power boom top ×1

Length (L)	12.20m
Width (W)	3.56m
Height (H)	3.25m
Weight	6.53t

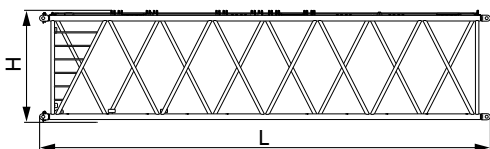

### 12m power boom insert A ×1

Length(L)	12.20m
Width(W)	3.56m
Height(H)	3.25m
Weight	6.36t

## Transport Dimensions

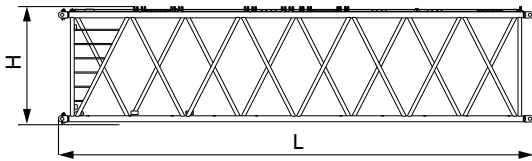

### 12m power boom insert B ×2

Length(L)	12.20m
Width(W)	3.56m
Height(H)	3.25m
Weight	6.73t

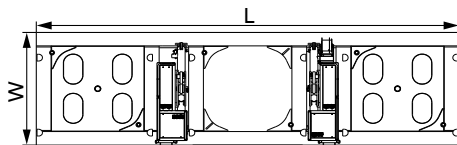

### Superlift counterweight tray ×1

Length(L)	8.60m
Width(W)	2.50m
Height(H)	1.85m
Weight	10.0t

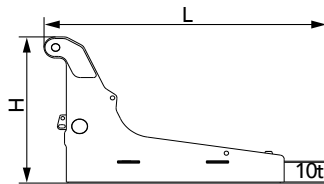

### Rear counterweight tray ×2

Length(L)	3.18m
Width(W)	2.83m
Height(H)	1.80m
Weight	10.0t

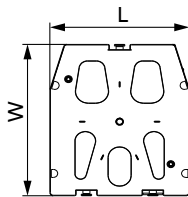

### 10t counterweight block ×38

Length(L)	2.40m
Width(W)	2.85m
Height(H)	0.48m
Weight	10.0t

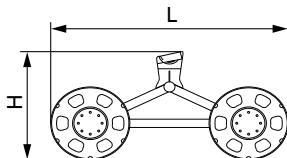

### Trolley ×1

Length(L)	3.00m
Width(W)	2.05m
Height(H)	1.50m
Weight	1.09t

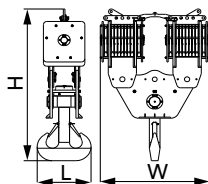

### 450t hook ×1

Length(L)	1.33m
Width(W)	2.69m
Height(H)	4.07m
Weight	10.80t



## Transport Dimensions

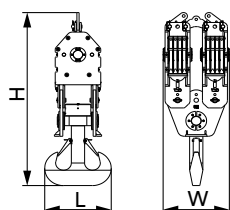

240t hook		×1
Length(L)	1.18m	
Width(W)	1.19m	
Height(H)	3.58m	
Weight	4.71t	

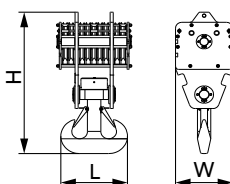

200t hook		×1
Length(L)	0.75m	
Width(W)	0.82m	
Height(H)	2.28m	
Weight	3.81t	

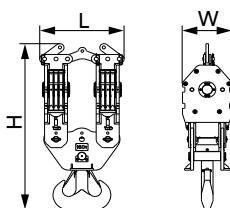

160t hook		×1
Length(L)	1.38m	
Width(W)	0.81m	
Height(H)	2.99m	
Weight	3.81t	

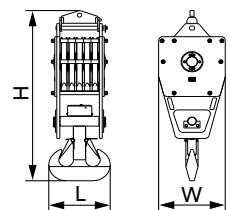

130t hook		×1
Length(L)	0.75m	
Width(W)	0.82m	
Height(H)	2.28m	
Weight	3.06t	

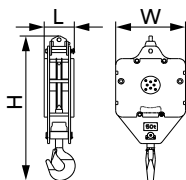

50t hook		×1
Length(L)	0.45m	
Width(W)	1.02m	
Height(H)	2.30m	
Weight	2.52t	

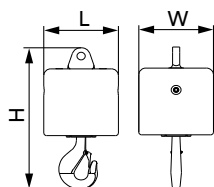

16t hook		×1
Length(L)	0.53m	
Width(W)	0.53m	
Height(H)	1.10m	
Weight	0.94t	

## Transport Dimensions

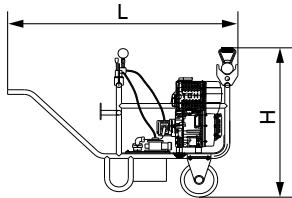

### Portable power pack ×1

Length(L)	1.55m
Width(W)	0.70m
Height(H)	1.09m
Weight	0.20t

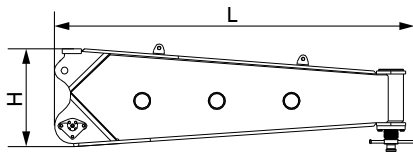

### Side boom erection outrigger ×2

Length(L)	3.62m
Width(W)	0.80m
Height(H)	0.98m
Weight	1.58t

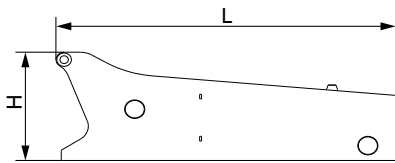

### Carbody counterweight ×2

Length(L)	3.03m
Width(W)	2.94m
Height(H)	1.05m
Weight	15.0t

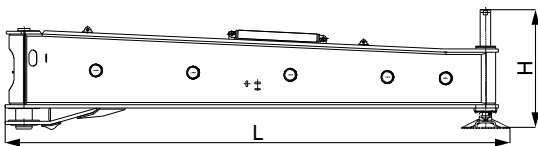

### Front boom erection outrigger ×2

Length(L)	6.08m
Width(W)	0.43m
Height(H)	1.18m
Weight	4.70t

Note:

- 1.The dimension listed is schematic, which is not proportional. All the dimensions are designed values without packing.
- 2.The dimensions are subject to deviation due to manufacturing tolerances.

## Transport Plan

Trailer 1	<ul style="list-style-type: none"> <li>Length 17.5m, Width 2.5m,</li> <li>Height 0.576m, Rated load 60t</li> </ul>
Transport weight	46t
Part	<ul style="list-style-type: none"> <li>Rotating platform,</li> <li>Carbody</li> </ul>
Truckload	1+1

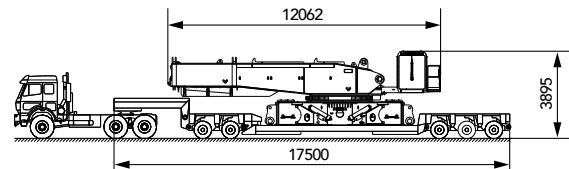

Trailer 2	<ul style="list-style-type: none"> <li>Length 17.5m, Width 2.5m,</li> <li>Height 1.2m, Rated load 35t</li> </ul>
Transport weight	30.5t
Part	Crawler frame assembly
Truckload	1

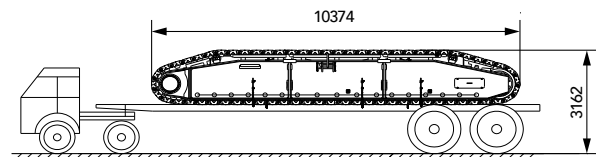

Trailer 3	<ul style="list-style-type: none"> <li>Length 17.5m, Width 2.5m,</li> <li>Height 1.2m, Rated load 35t</li> </ul>
Transport weight	30.5t
Part	Crawler frame assembly
Truckload	1

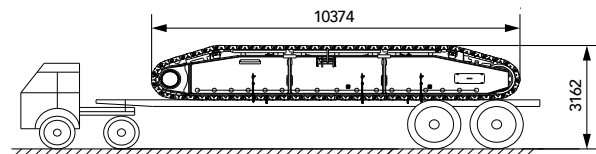

Trailer 4	<ul style="list-style-type: none"> <li>Length 17.5m, Width 2.5m,</li> <li>Height 1.2m, Rated load 35t</li> </ul>
Transport weight	32.112t
Part	<ul style="list-style-type: none"> <li>Boom base</li> <li>10t counterweight block</li> </ul>
Truckload	1+1

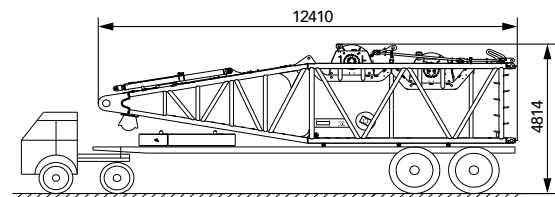

Trailer 5	<ul style="list-style-type: none"> <li>Length 17.5m, Width 2.5m,</li> <li>Height 1.2m, Rated load 35t</li> </ul>
Transport weight	27.07t
Part	<ul style="list-style-type: none"> <li>Boom top</li> <li>10t counterweight block</li> <li>Base plate</li> </ul>
Truckload	1+1+1

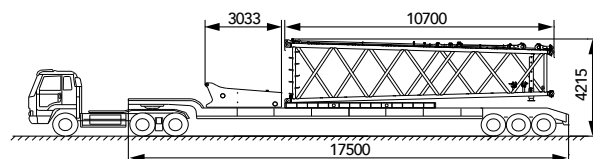

Trailer 6.7	<ul style="list-style-type: none"> <li>Length 17.5m, Width 2.5m,</li> <li>Height 1.2m, Rated load 35t</li> </ul>
Transport weight	35.075t
Part	<ul style="list-style-type: none"> <li>12m boom insert A</li> <li>12m luffing jib insert</li> <li>12m power boom insert B</li> <li>10t counterweight block</li> </ul>
Truckload	1+1+1+2

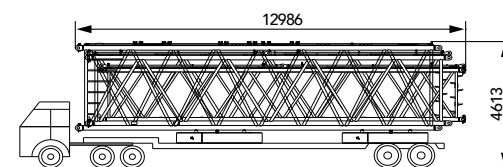

## Transport Plan

Trailer 8	<ul style="list-style-type: none"> <li>Length 17.5m, Width 2.5m,</li> <li>Height 1.2m, Rated load 35t</li> </ul>
Transport weight	35.515t
Part	<ul style="list-style-type: none"> <li>12m boom insert A</li> <li>12m luffing jib insert</li> <li>12m power boom insert A</li> <li>10t counterweight block</li> </ul>
Truckload	1+1+1+2
Trailer 9	<ul style="list-style-type: none"> <li>Length 17.5m, Width 2.5m,</li> <li>Height 1.2m, Rated load 35t</li> </ul>
Transport weight	29.155t
Part	<ul style="list-style-type: none"> <li>12m boom insert A</li> <li>12m luffing jib insert</li> <li>10t counterweight block</li> <li>Side boom erection outrigger</li> </ul>
Truckload	1+1+2+2
Trailer 10	<ul style="list-style-type: none"> <li>Length 17.5m, Width 2.5m,</li> <li>Height 1.2m, Rated load 35t</li> </ul>
Transport weight	25.242t
Part	<ul style="list-style-type: none"> <li>6m boom insert</li> <li>6m luffing jib insert B</li> <li>Connection tip</li> <li>Pulley blocks</li> <li>Carbody counterweight tray</li> </ul>
Truckload	1+1+1+2+1
Trailer 11	<ul style="list-style-type: none"> <li>Length 17.5m, Width 2.5m,</li> <li>Height 1.2m, Rated load 35t</li> </ul>
Transport weight	25.152t
Part	<ul style="list-style-type: none"> <li>6m boom insert</li> <li>6m luffing jib insert B</li> <li>10t counterweight block</li> </ul>
Truckload	1+1+2
Trailer 12	<ul style="list-style-type: none"> <li>Length 17.5m, Width 2.5m,</li> <li>Height 1.2m, Rated load 35t</li> </ul>
Transport weight	32.11t
Part	<ul style="list-style-type: none"> <li>Main hoisting mast and winch</li> <li>10t counterweight block</li> </ul>
Truckload	1+2
Trailer 13	<ul style="list-style-type: none"> <li>Length 17.5m, Width 2.5m,</li> <li>Height 1.2m, Rated load 35t</li> </ul>
Transport weight	29.36t
Part	<ul style="list-style-type: none"> <li>Jib top</li> <li>Portable power plant</li> <li>Jib luffing mechanism</li> <li>10t counterweight block</li> </ul>
Truckload	1+1+1+2

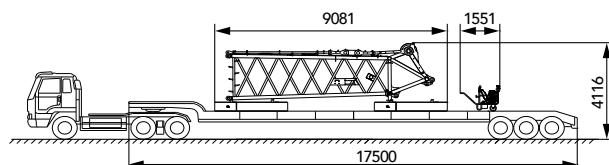
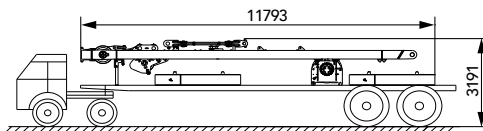
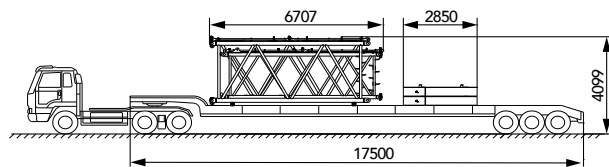
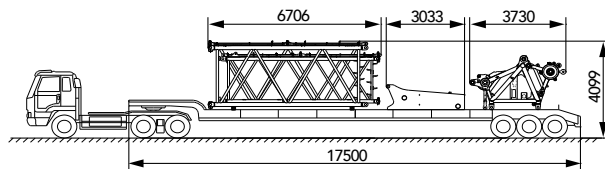
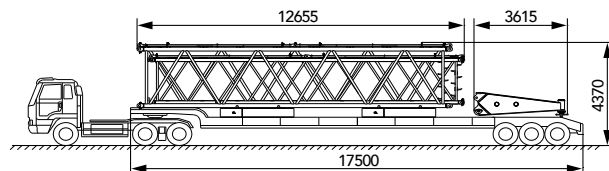
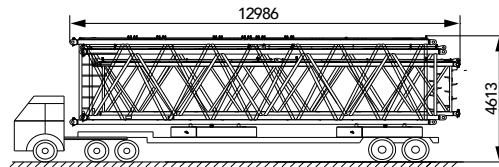

## Transport Plan

Trailer 14	<ul style="list-style-type: none"> <li>Length 17.5m, Width 2.5m,</li> <li>Height 1.2m, Rated load 35t</li> </ul>
Transport weight	30.11t
Part	<ul style="list-style-type: none"> <li>Luffing jib base,</li> <li>Base plate,</li> <li>10t counterweight block</li> </ul>
Truckload	1+1+2

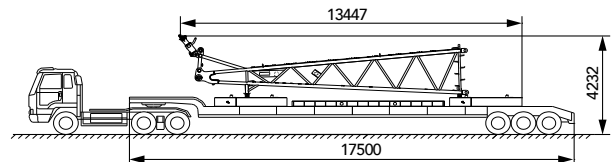

Trailer 15	<ul style="list-style-type: none"> <li>Length 17.5m, Width 2.5m,</li> <li>Height 1.2m, Rated load 35t</li> </ul>
Transport weight	30.794t
Part	<ul style="list-style-type: none"> <li>Front and rear luffing mast,</li> <li>10t counterweight block</li> </ul>
Truckload	1+1+2

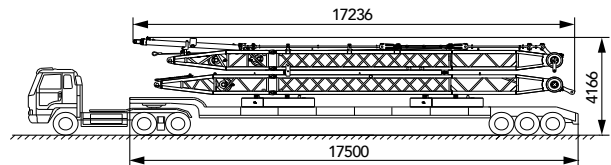

Trailer 16	<ul style="list-style-type: none"> <li>Length 17.5m, Width 2.5m,</li> <li>Height 1.2m, Rated load 35t</li> </ul>
Transport weight	25.624t
Part	<ul style="list-style-type: none"> <li>6m luffing jib insert A,</li> <li>Trolley,</li> <li>3m boom insert,</li> <li>10t counterweight block</li> </ul>
Truckload	1+1+1+2

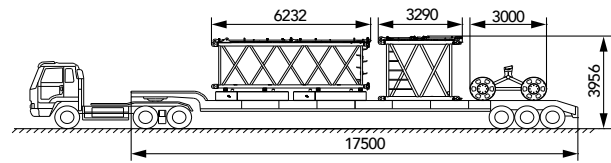

Trailer 17	<ul style="list-style-type: none"> <li>Length 17.5m, Width 2.5m,</li> <li>Height 1.2m, Rated load 35t</li> </ul>
Transport weight	29.24t
Part	<ul style="list-style-type: none"> <li>Superlift mast top,</li> <li>10t counterweight block</li> </ul>
Truckload	1+2

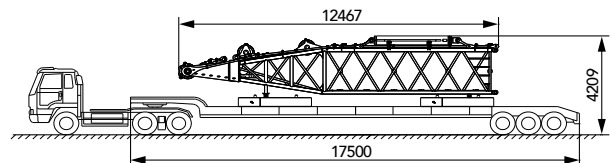

Trailer 18	<ul style="list-style-type: none"> <li>Length 17.5m, Width 2.5m,</li> <li>Height 1.2m, Rated load 35t</li> </ul>
Transport weight	30.11t
Part	<ul style="list-style-type: none"> <li>Superlift mast base and superlift luffing mechanism,</li> <li>Base plate,</li> <li>10t counterweight block</li> </ul>
Truckload	1+1+1

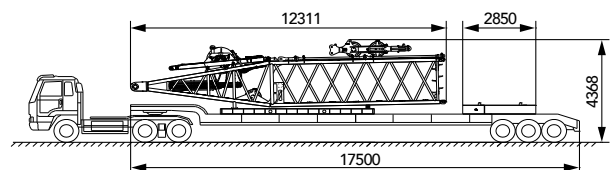

Trailer 19	<ul style="list-style-type: none"> <li>Length 17.5m, Width 2.5m,</li> <li>Height 1.2m, Rated load 35t</li> </ul>
Transport weight	30.01t
Part	<ul style="list-style-type: none"> <li>Superlift mast top,</li> <li>Base plate,</li> <li>Packing cases,</li> <li>10t counterweight block</li> </ul>
Truckload	1+1+2+2

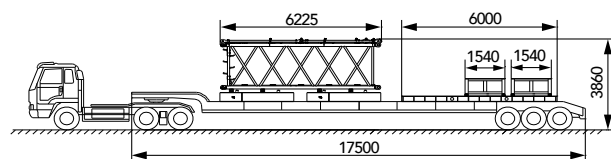

## Transport Plan

Trailer 20	<ul style="list-style-type: none"> <li>Length 17.5m, Width 2.5m,</li> <li>Height 1.2m, Rated load 35t</li> </ul>
Transport weight	25.28t
Part	<ul style="list-style-type: none"> <li>Fixed jib,</li> <li>10t counterweight block</li> </ul>
Truckload	1+2

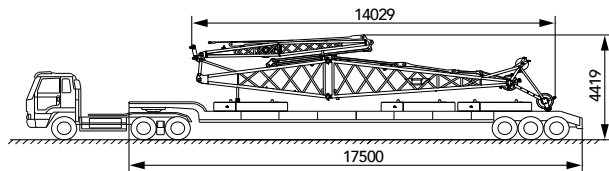

Trailer 21	<ul style="list-style-type: none"> <li>Length 17.5m, Width 2.5m,</li> <li>Height 1.2m, Rated load 35t</li> </ul>
Transport weight	30t
Part	<ul style="list-style-type: none"> <li>Superlift counterweight tray</li> <li>10t counterweight block</li> </ul>
Truckload	1+2

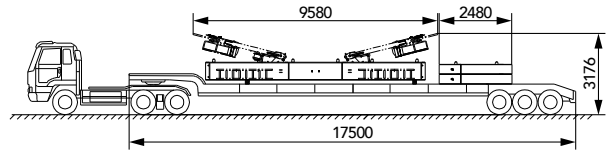

Trailer 22	<ul style="list-style-type: none"> <li>Length 17.5m, Width 2.5m,</li> <li>Height 1.2m, Rated load 35t</li> </ul>
Transport weight	26.98t
Part	<ul style="list-style-type: none"> <li>12m transitional base,</li> <li>Rear counterweight tray,</li> <li>10t counterweight block</li> </ul>
Truckload	1+1+1

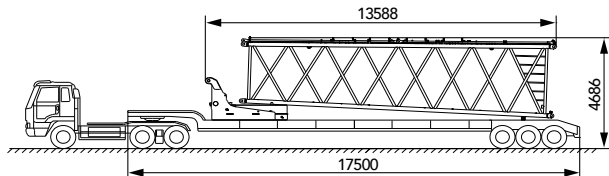

Trailer 23	<ul style="list-style-type: none"> <li>Length 17.5m, Width 2.5m,</li> <li>Height 1.2m, Rated load 35t</li> </ul>
Transport weight	26.59t
Part	<ul style="list-style-type: none"> <li>12m transitional top,</li> <li>Rear counterweight tray,</li> <li>10t counterweight block</li> </ul>
Truckload	1+1+1

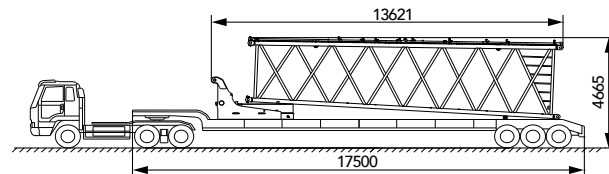

Trailer 24	<ul style="list-style-type: none"> <li>Length 17.5m, Width 2.5m,</li> <li>Height 1.2m, Rated load 35t</li> </ul>
Transport weight	28t
Part	<ul style="list-style-type: none"> <li>Ramp plate,</li> <li>Base plate,</li> <li>10t counterweight block</li> </ul>
Truckload	2+1+2

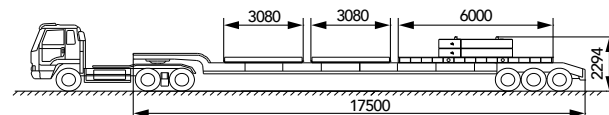

Trailer 25	<ul style="list-style-type: none"> <li>Length 17.5m, Width 2.5m,</li> <li>Height 1.2m, Rated load 35t</li> </ul>
Transport weight	27.3t
Part	<ul style="list-style-type: none"> <li>Front boom erection outrigger,</li> <li>10t counterweight block</li> </ul>
Truckload	2+2

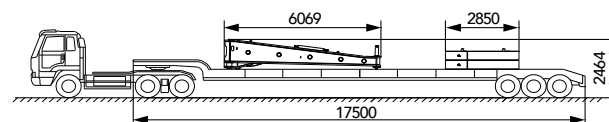

## Transport Plan

Trailer 26	<ul style="list-style-type: none"> <li>▪ Length 17.5m, Width 2.5m,</li> <li>▪ Height 1.2m, Rated load 35t</li> </ul>
Transport weight	<ul style="list-style-type: none"> <li>▪ 30.35t</li> </ul>
Part	<ul style="list-style-type: none"> <li>▪ 16t ball hook,</li> <li>▪ 50t hook,</li> <li>▪ 130t lifting hook,</li> <li>▪ 160t hook,</li> <li>▪ 200t lifting hook,</li> <li>▪ 240t lifting hook,</li> <li>▪ 450t hook,</li> </ul>
Truckload	<ul style="list-style-type: none"> <li>▪ 1+1+1+1+1+1</li> </ul>

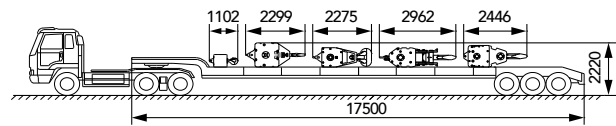



## Self-Assembly Plan

### Crawler frame self-assembly

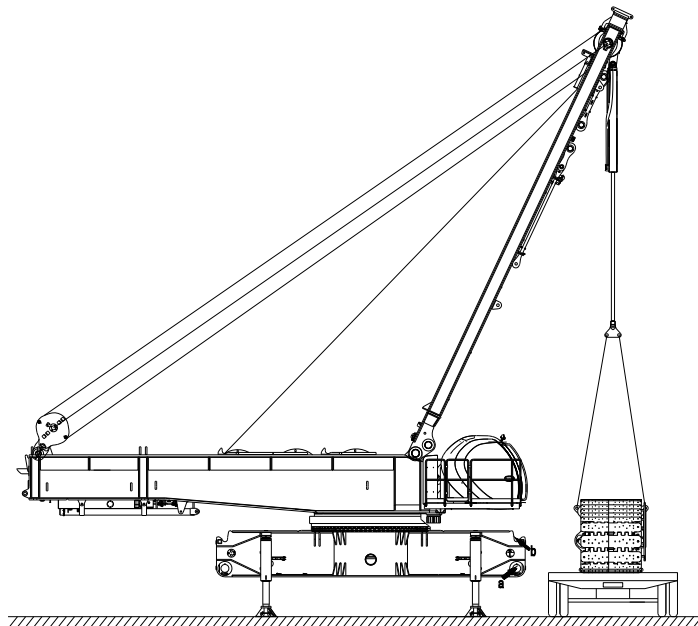
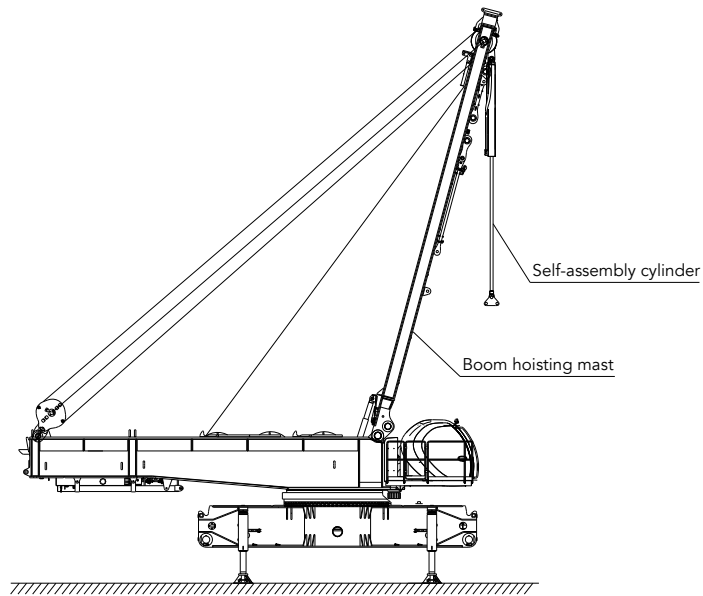



# **SCE4800A SANY CRAWLER CRANE 480 TONS LIFTING CAPACITY**

QUALITY CHANGES THE WORLD

## Configurations

- Page 31 HJFJ-2 Configuration
- Page 35 HJFJDB-5 Configuration
- Page 41 H Configuration
- Page 44 HDB Configuration
- Page 48 HJ Configuration
- Page 51 HJDB Configuration
- Page 55 LJ(DB) Configuration
- Page 62 Working Radius of LJDB Configuration



## Configurations

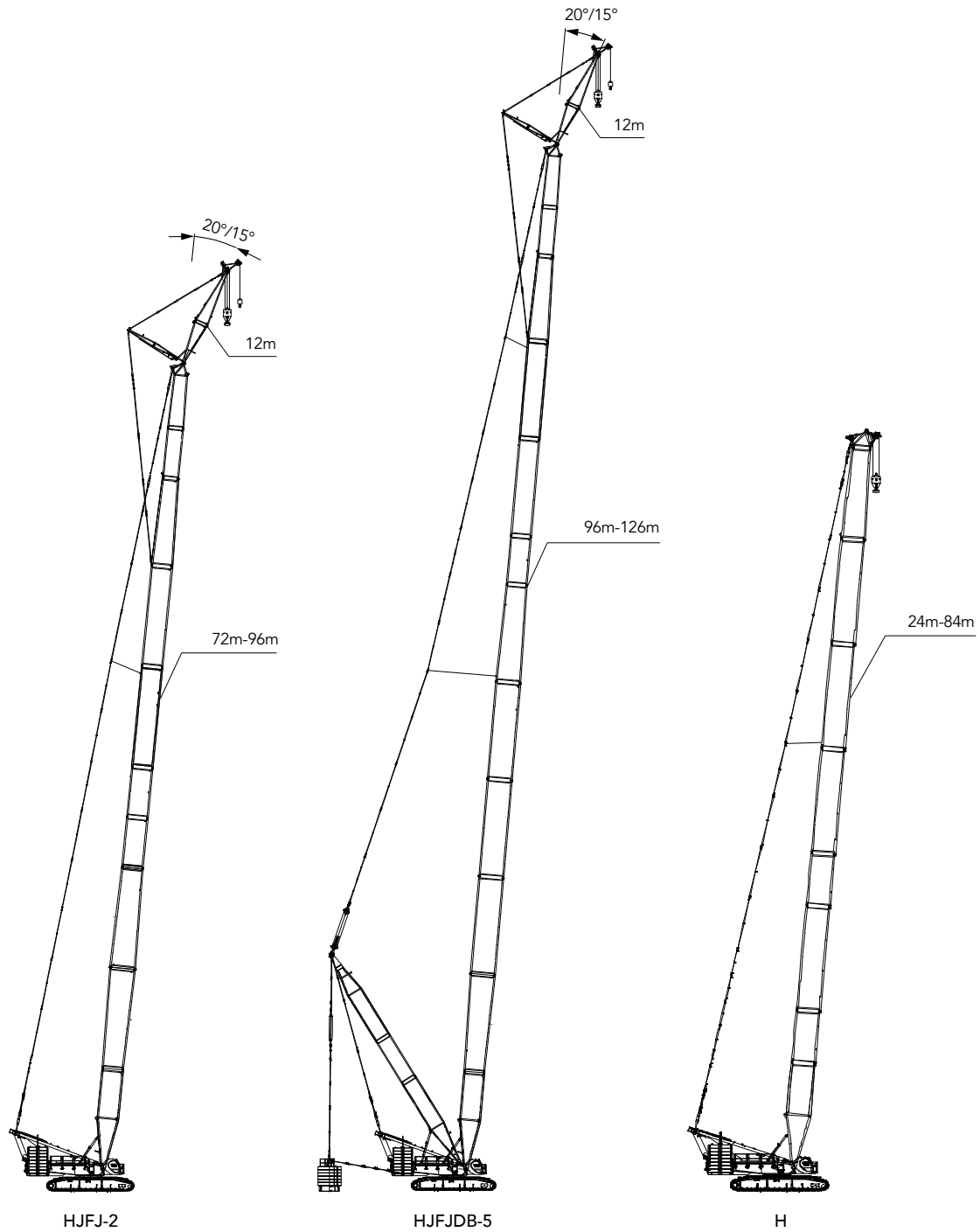

## Configurations

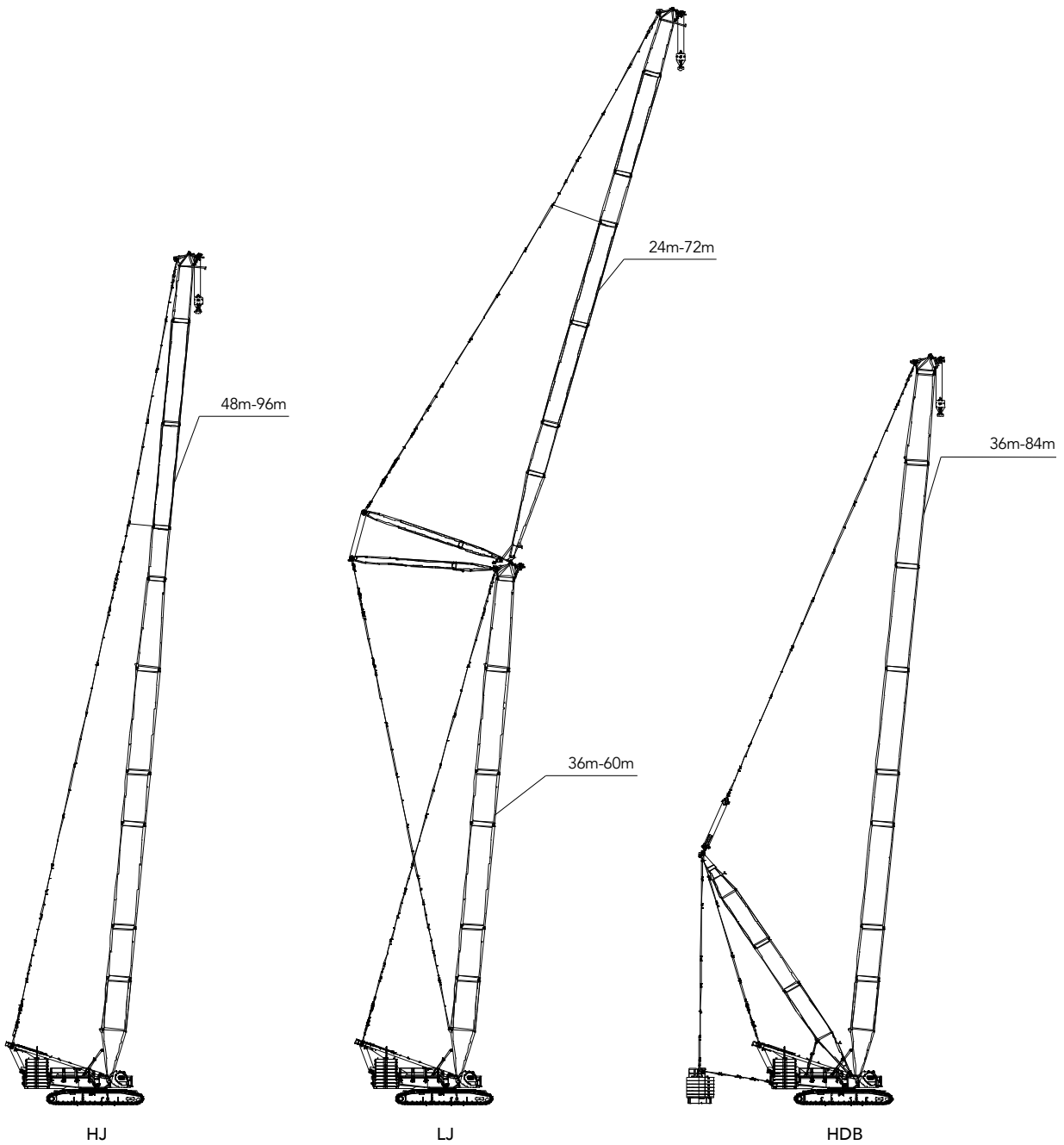

# Configurations

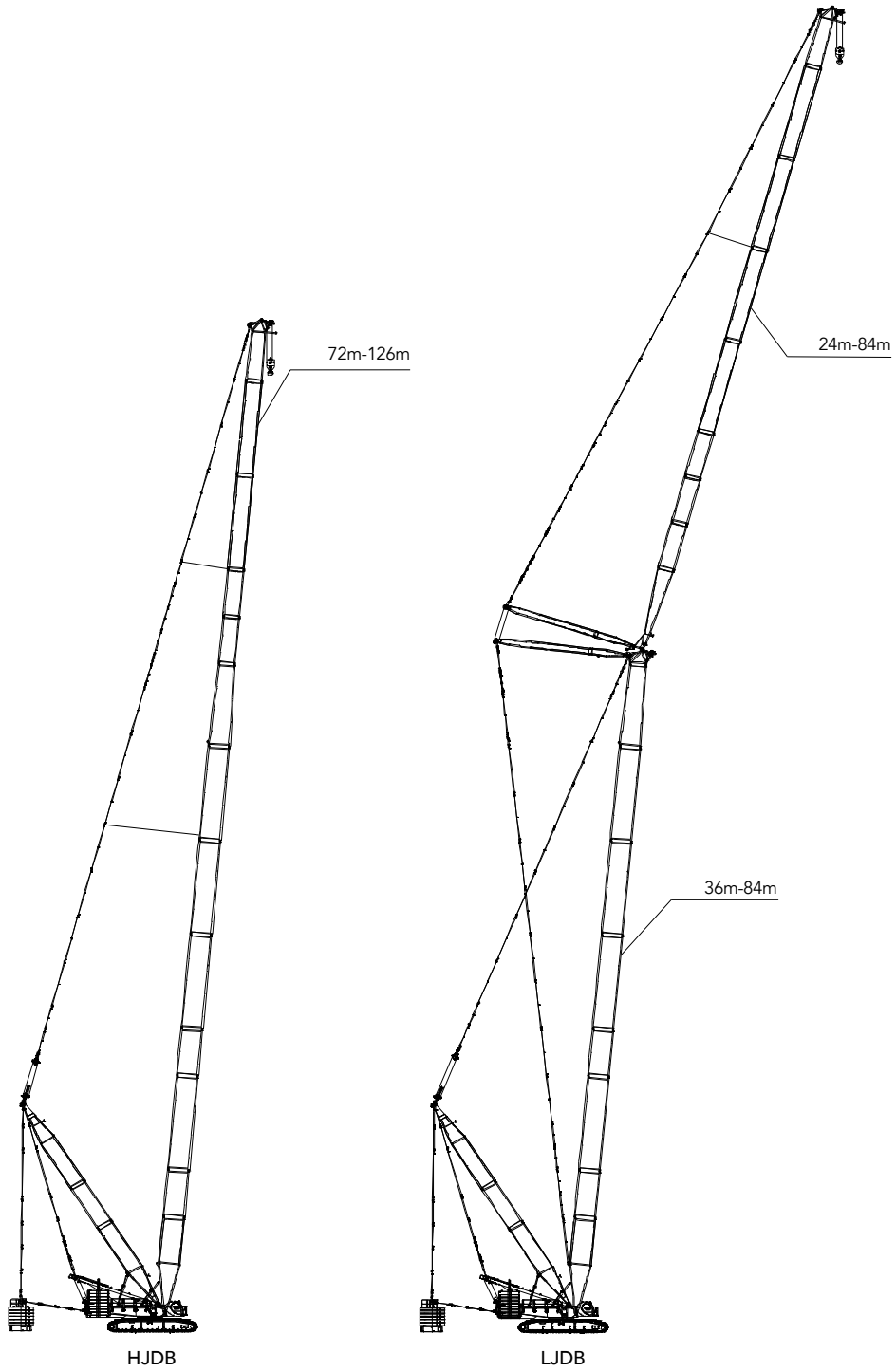

## Boom Combination in HJFJ-2

Boom Combination in HJFJ-2						
Boom length (m)	Standard boom insert			Power boom		Jib insert
	3m /(H5)	6m /(H6)	12mA /(H8A)	12m transition base/ (ZH4A)	12m transition top/ (ZH4B)	6mA /(LJ6A)
72*	-	-	1	1	1	1
78*	-	1	1	1	1	1
84*	-	2	1	1	1	1
90*	-	1	2	1	1	1
93*	1	1	2	1	1	1
96*	-	2	2	1	1	1

Notes: Combinations marked "\*" mean the mid-point suspension cable is must, otherwise, the boom may break.

The use the mid-point suspension cable must be strictly in accordance to the instructions.

Attention: If the boom length is 78m or more, the crane must boom up from side by side erection outrigger or from the front by the special front erection outrigger, otherwise the crane may tip over.

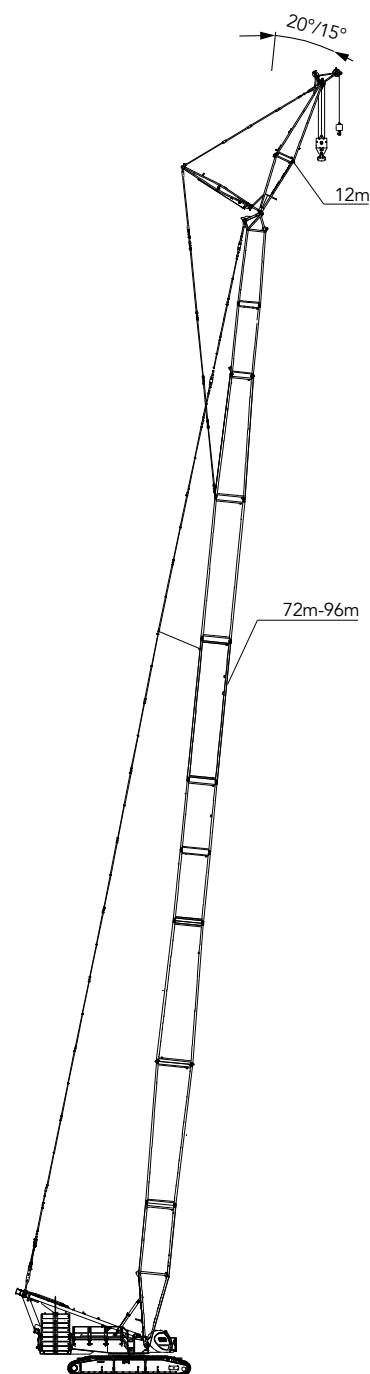

# Working Radius in HJFJ-2

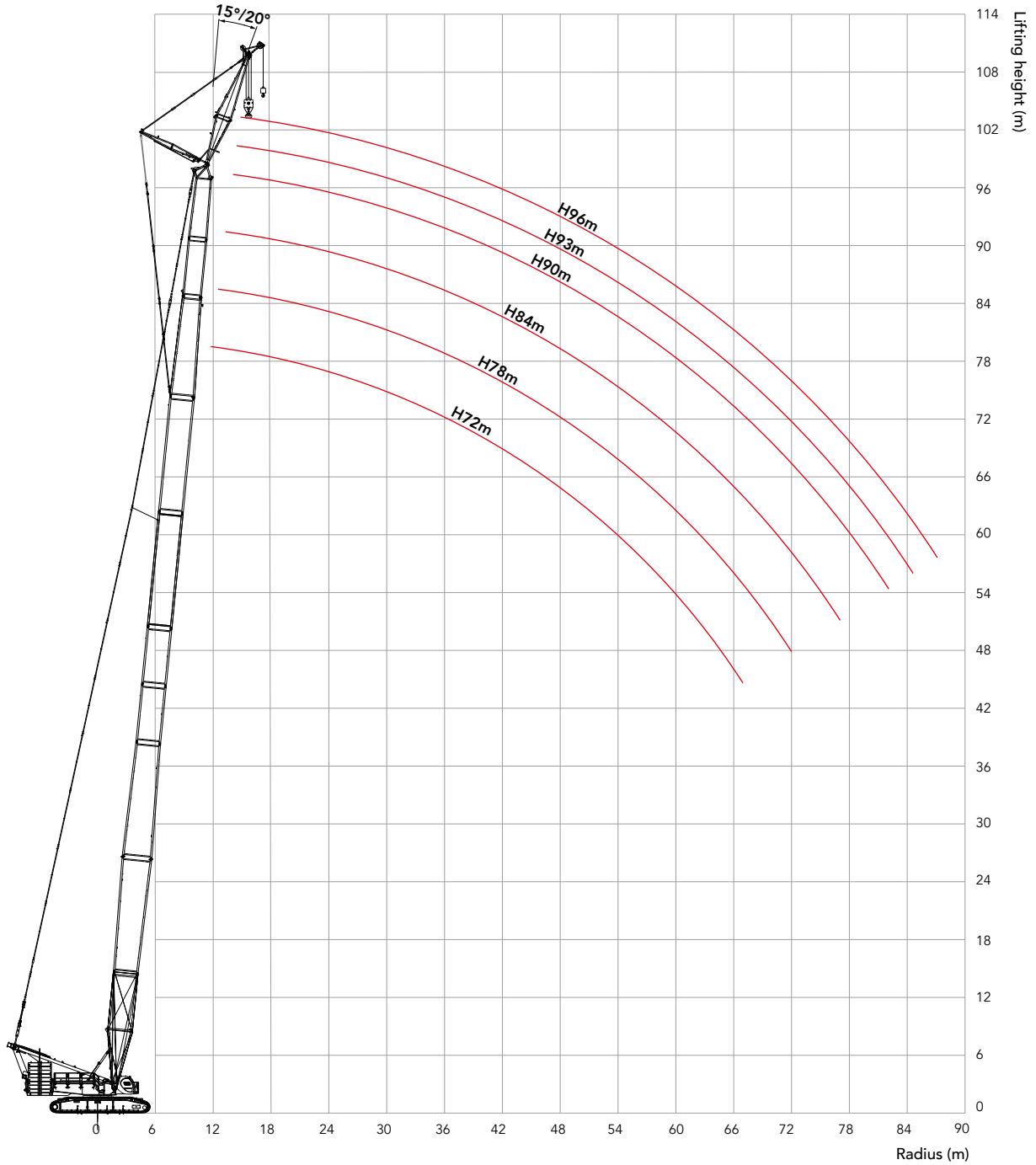



Unit: t

**Load Chart of HJFJ-2****Note:**

- 1.The rated load in the load chart is calculated complying with EN 13000; do not exceed 75% of a static tipping load.
- 2.The working radius is the horizontal distance from the load center to the swing center.
- 3.The actual lifting capacity must subtract the weight of hooks and other riggings from the rated capacity in the load chart.
- 4.The load value is calculated when the object is hung freely,without considering the influence of wind on the load, ground conditions and slope, operation speed and the influence of any other negative factors over safe operation. Therefore, the operator bears the responsibility of making a judgement and decreasing the load and lowering speed.
- 5.All ratings are calculated when the machine is parking on firm and level ground with less than 1% gradient.

**SCE4800A—HJFJ-2 1/2**

Boom length: 72~96m, Jib length: 12m, Boom to jib angle: 15°,Rear counterweight: 180t, Carbody counterweight: 50t

Radius (m)	72	78	84	90	93	96	Radius (m)
14	142	140	135	132	127	125	14
16	130	127	123	119	118	116	16
18	115	112	109	105	104	103	18
20	102	99.4	96.7	94	92.5	91.4	20
22	91.8	89.2	86.8	84.3	83	82	22
24	82.9	80.6	78.4	76.1	74.9	74	24
26	75.3	73.1	71.2	69	67.9	67.1	26
28	68.8	66.7	64.9	62.9	61.8	61.1	28
30	63	61.1	59.4	57.5	56.5	55.8	30
32	57.6	56.2	54.5	52.7	51.8	51.1	32
34	52.7	51.8	50.2	48.5	47.5	46.9	34
36	48.3	47.4	46.3	44.7	43.8	43.2	36
38	44.5	43.6	42.9	41.2	40.3	39.8	38
40	41.1	40.2	39.4	38.1	37.3	36.7	40
44	35.2	34.3	33.6	32.7	31.8	31.4	44
48	30.4	29.5	28.8	27.8	27.3	26.8	48
52	26.3	25.4	24.7	23.8	23.2	23	52
56	22.9	22	21.3	20.3	19.8	19.6	56
60	19.9	19	18.3	17.4	16.8	16.6	60
64	17.3	16.4	15.7	14.8	14.2	14	64
68	15	14.1	13.4	12.5	11.9	11.7	68
72	12.9	12.1	11.4	10.5	9.9	8.8	72
76	11.1	10.2	9.6	8.6	7.4	6.1	76
80		8.6	7.6	7	4.7	3.5	80
84			4.9	4.7			84

**Load Chart of HJFJ-2**

SCE4800A—HJFJ-2 2/2							
Boom length: 72~96m, Jib length: 12m, Boom to jib angle: 20°, Rear counterweight: 180t, Carbody counterweight: 50t							
Radius (m)	72	78	84	90	93	96	Radius (m)
14	130	129	124				14
16	128	127	122	121	116	114	16
18	116	113	110	107	105	104	18
20	103	100	97.7	95	93.6	92.4	20
22	92.6	90.1	87.7	85.2	83.9	82.9	22
24	83.7	81.3	79.2	76.9	75.7	74.8	24
26	76	73.9	71.9	69.8	68.7	67.9	26
28	69.4	67.4	65.6	63.6	62.5	61.8	28
30	63.6	61.7	60	58.1	57.1	56.5	30
32	58.1	56.7	55.1	53.3	52.4	51.7	32
34	53.1	52.2	50.7	49	48.1	47.5	34
36	48.7	47.9	46.8	45.2	44.3	43.7	36
38	44.9	44	43.3	41.7	40.8	40.3	38
40	41.4	40.5	39.8	38.6	37.7	37.2	40
44	35.5	34.6	33.9	33	32.3	31.8	44
48	30.6	29.7	29.1	28.2	27.6	27.2	48
52	26.5	25.7	25	24.1	23.5	23.3	52
56	23	22.2	21.5	20.6	20.1	19.8	56
60	20	19.2	18.5	17.6	17	16.8	60
64	17.4	16.5	15.9	15	14.4	14.2	64
68	15.1	14.2	13.5	12.6	12.1	11.9	68
72	13	12.2	11.5	10.6	10.1	9.1	72
76	11.1	10.3	9.6	8.8	7.4	6.1	76
80		8.6	7.5	7.1	4.7	3.5	80
84			5.4	4.9			84

## Boom Combination in HJFJDB-5

Boom Combination in HJFJDB-5							
Boom length (m)	Standard boom insert		Power boom				Jib insert
	6m / (H6)	12mA/ (H8A)	12m transition base/(ZH4A)	12m power boom insert A/ (ZH8A)	12m power boom insert B/ (ZH8B)	12m transition top/(ZH4B))	6mA / (LJ6A)
96*	-	-	1	1	2	1	1
102*	1	-	1	1	2	1	1
108*	0	1	1	1	2	1	1
114*	1	1	1	1	2	1	1
120*	0	2	1	1	2	1	1
126*	1	2	1	1	2	1	1

Note:Combinations marked "\*" mean the mid-point suspension cable is must, otherwise, the boom may break.  
The use of the mid-point suspension cable must be strictly in accordance to the instructions.

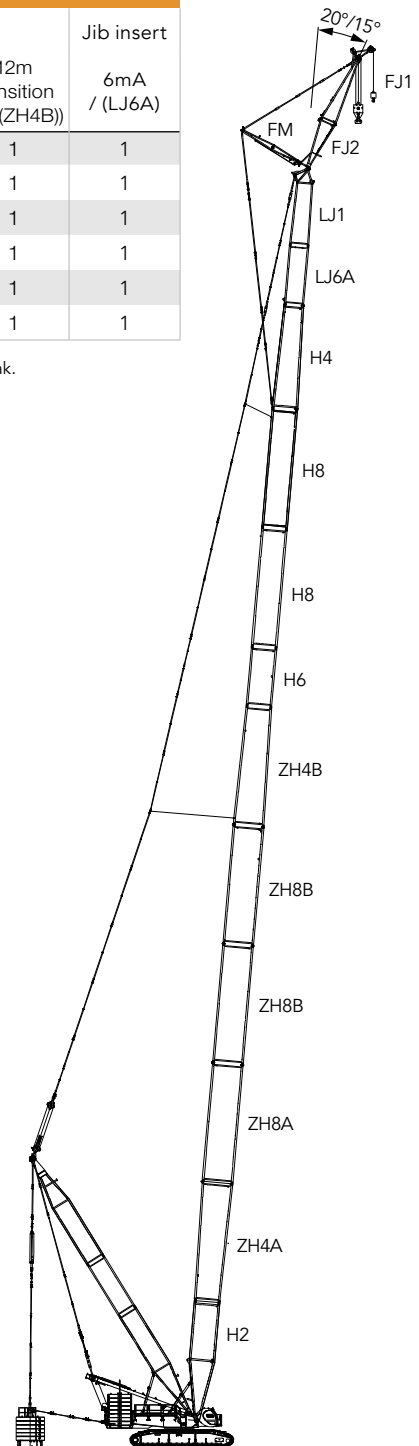

### Working Radius in HJFJDB-5

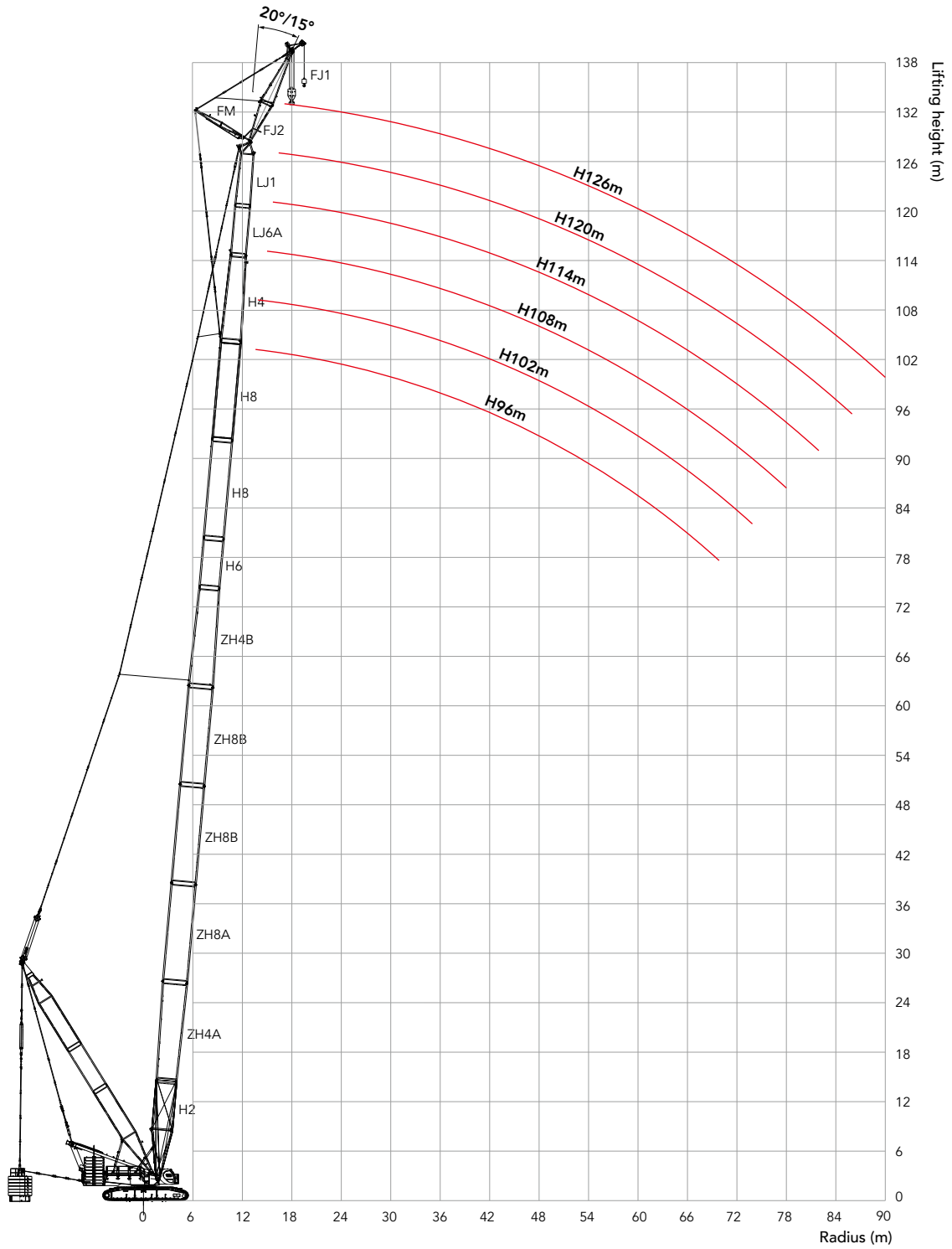

Unit: t

### Load Chart of HJFJDB-5

Load Chart- HJFJDB-5 (Superlift counterweight 0t, Rear counterweight 180t)							
Boom length 96~126m, Jib length 12m, <b>Boom to jib angle 15°</b> , Superlift radius 15m, Carbody counterweight 50t							
Radius(m)	Boom length (m)						Radius(m)
	96	102	108	114	120	126	
14	133						14
16	126	122	119	115	112	103	16
18	111	108	105	102	99.5	96.7	18
20	99.2	96.4	94.0	91.3	88.9	86.3	20
22	89.1	86.6	84.5	82.0	79.9	77.5	22
24	80.6	78.3	76.3	74.1	72.1	69.9	24
26	73.2	71.1	69.3	67.2	65.4	63.3	26
28	66.8	64.8	63.1	61.2	59.5	57.5	28
30	61.2	59.3	57.7	55.8	54.3	52.4	30
32	56.2	54.4	52.9	51.1	49.6	47.8	32
34	51.7	50.0	48.6	46.9	45.4	43.7	34
36	47.7	46.0	44.7	43.0	41.7	40.0	36
38	44.1	42.5	41.2	39.6	38.3	36.7	38
40	40.8	39.3	38.0	36.4	35.2	33.6	40
44	35.1	33.6	32.4	30.9	29.7	28.2	44
48	30.3	28.8	27.7	26.3	25.1	23.7	48
52	26.2	24.8	23.7	22.3	21.2	19.8	52
56	22.6	21.2	20.2	18.8	17.7	16.4	56
60	19.5	18.1	17.1	15.8	14.7	13.4	60
64	16.7	15.4	14.4	13.1	12.1	10.7	64
68	14.3	13.0	12.0	10.7	9.7	8.4	68
72	12.1	10.8	9.9	8.6	7.6	6.3	72
76	10.2	8.9	7.9	6.6	5.7	4.4	76
80	8.4	7.1	6.2	4.9	3.9		80
84	6.8	5.5	4.6	3.3			84
88	5.3	4.0	3.1				88
92	3.9						92

## Load Chart of HJFJDB-5

### Load Chart- HJFJDB-5 (Superlift counterweight 0t, Rear counterweight 180t)

Boom length 96~126m, Jib length 12m, **Boom to jib angle 20°**, Superlift radius 15m, Carbody counterweight 50t

Radius(m)	Boom length (m)						Radius(m)
	96	102	108	114	120	126	
16	120	115	111				16
18	112	109	106	104	101	98.0	18
20	100	97.5	95.1	92.4	90.1	87.5	20
22	90.1	87.6	85.5	83.1	81.0	78.6	22
24	81.5	79.2	77.3	75.0	73.1	70.9	24
26	74.0	71.9	70.1	68.1	66.3	64.3	26
28	67.5	65.6	63.9	62.0	60.3	58.4	28
30	61.8	60.0	58.4	56.6	55.0	53.2	30
32	56.8	55.0	53.6	51.8	50.3	48.6	32
34	52.3	50.6	49.2	47.5	46.1	44.4	34
36	48.3	46.6	45.3	43.7	42.3	40.7	36
38	44.6	43.0	41.8	40.2	38.9	37.3	38
40	41.3	39.8	38.5	37.0	35.7	34.2	40
44	35.5	34.0	32.9	31.4	30.2	28.8	44
48	30.6	29.2	28.1	26.7	25.6	24.1	48
52	26.5	25.1	24.1	22.7	21.6	20.2	52
56	22.9	21.5	20.5	19.2	18.1	16.7	56
60	19.7	18.4	17.4	16.1	15.1	13.7	60
64	17.0	15.7	14.7	13.4	12.4	11.0	64
68	14.5	13.2	12.3	11.0	10.0	8.7	68
72	12.3	11.0	10.1	8.8	7.8	6.5	72
76	10.3	9.0	8.1	6.8	5.9	4.6	76
80	8.5	7.2	6.4	5.1	4.1		80
84	6.9	5.6	4.7	3.5			84
88	5.4	4.1	3.3				88
92	4.0						92
92	3.9						92

## Load Chart of HJFJDB-5

### Load Chart- HJFJDB-5 (Superlift counterweight: 250t, Rear counterweight: 140t)

Boom length: 96~126m, Jib length: 12m, **Boom to jib angle: 15°**, Superlift radius: 15m, Carbody counterweight: 50t

Radius(m)	Boom length (m)						Radius(m)
	96	102	108	114	120	126	
14	133*						14
16	130*	124*	120*	123*	116*	103*	16
18	127*	121*	117*	120*	116*	102*	18
20	123*	118*	113*	118*	113*	101*	20
22	120*	115*	111*	115*	111*	101*	22
24	117*	112*	108*	113*	109*	99.9*	24
26	113*	109*	105*	110*	106*	99.0*	26
28	110*	106*	102*	108*	104*	98.0*	28
30	107*	103*	99.6*	106*	102*	96.6*	30
32	104*	101*	97.1*	103*	99.8*	93.5*	32
34	102	97.8*	94.5*	101	96.4	90.4*	34
36	99.5	95.1	92.0	98.7	93.6	87.3*	36
38	97.5	93.2	90.0	97.0	90.3	84.8	38
40	95.0	90.9	88.1	94.7	88.1	82.2	40
44	90.5	86.7	84.0	91.3	82.7	77.3	44
48	87.2	83.2	79.8	87.3	78.5	72.9	48
52	83.8	79.8	75.6	84.7	74.4	68.7	52
56	80.9	76.7	71.9	80.8	70.5	65.5	56
60	77.4	73.3	68.7	74.6	67.1	62.5	60
64	71.1	70.1	65.8	68.4	64.1	59.5	64
68	65.6	64.6	63.4	62.9	61.6	56.7	68
72	60.6	59.6	59.0	57.9	57.2	54.3	72
76	56.2	55.2	54.5	53.5	52.8	51.7	76
80	52.2	51.2	50.5	49.5	48.8	47.8	80
84	48.5	47.6	46.9	45.9	45.2	44.2	84
88	45.2	44.3	43.6	42.6	41.9	40.9	88
92	42.2	41.2	40.6	39.6	38.9	37.9	92
96		38.5	37.8	36.9	36.2	35.1	96
100			35.3	34.3	33.6	32.6	100
104				31.9	31.2	30.2	104
108					29.0	28.0	108
112					27.0	26.0	112
116						24.1	116

**Load Chart of HJFJDB-5****Load Chart- HJFJDB-5 (Superlift counterweight: 250t, Rear counterweight: 140t)**Boom length: 96~126m, Jib length: 12m, **Boom to jib angle: 20°**, Superlift radius: 15m, Carbody counterweight: 50t

Radius(m)	Boom length (m)						Radius(m)
	96	102	108	114	120	126	
16	120*	115*	111*				16
18	118*	112*	108*	111*	108*	101*	18
20	114*	110*	106*	110*	106*	101*	20
22	112*	107*	103*	108*	104*	100*	22
24	109*	105*	101*	106*	102*	98.1*	24
26	106*	102*	98.3*	104*	100*	96.3*	26
28	104*	99.5*	96.1*	102*	98.0*	94.4*	28
30	101*	97.5*	93.7*	99.6*	96.0*	92.5*	30
32	99.2*	95.0*	91.4*	97.4*	94.0*	90.0*	32
34	96.4*	92.5*	89.5*	95.3*	92.0*	87.6*	34
36	94.6	90.8*	87.2*	93.8	89.9	84.6*	36
38	92.3	88.2	85.5	91.6	87.3	82.2	38
40	89.9	86.5	83.8	90.1	85.2	79.8	40
44	86.5	83.2	80.2	87.0	80.0	75.0	44
48	82.9	79.5	77.0	83.9	76.0	71.2	48
52	80.2	77.0	73.7	80.8	72.1	67.6	52
56	77.9	73.5	70.3	78.3	68.7	64.1	56
60	75.0	71.1	67.3	74.9	65.5	61.1	60
64	71.3	68.3	64.6	68.6	62.8	58.2	64
68	65.8	64.8	61.8	63.1	60.3	55.8	68
72	60.8	59.8	59.2	58.1	57.4	53.6	72
76	56.3	55.4	54.7	53.7	53.0	51.4	76
80	52.3	51.3	50.7	49.7	49.0	48.0	80
84	48.6	47.7	47.1	46.1	45.4	44.4	84
88	45.3	44.4	43.7	42.8	42.1	41.1	88
92	42.2	41.3	40.7	39.7	39.1	38.0	92
96		38.5	37.9	37.0	36.3	35.3	96
100			35.3	34.4	33.7	32.7	100
104				32.0	31.3	30.3	104
108					29.1	28.1	108
112					27.1	26.1	112
116						24.2	116



## Boom Combination in H

Boom Combination in H		
Boom length(m)	Boom insert	
	6m/ (H6)	12mA/(H8A)
24	-	-
30	1	-
36	2	-
42	1	1
48	2	1
54	1	2
60	2	2
66	1	3
72	2	3
78*	1	4
84*	2	4

Note: Combinations marked "\*" mean when boom length is 78m, 84m or more, the mid-point suspension cable is must, otherwise, the boom may break.

Attention: if the boom length is 78m or more, the crane must boom up from side by side erection outrigger, otherwise the crane may tip over.

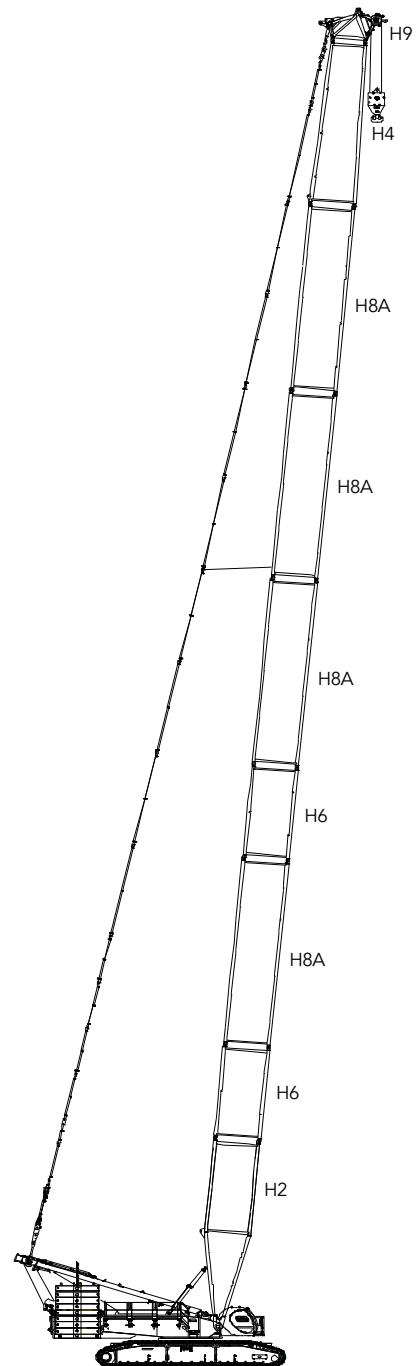

# Working Radius in H

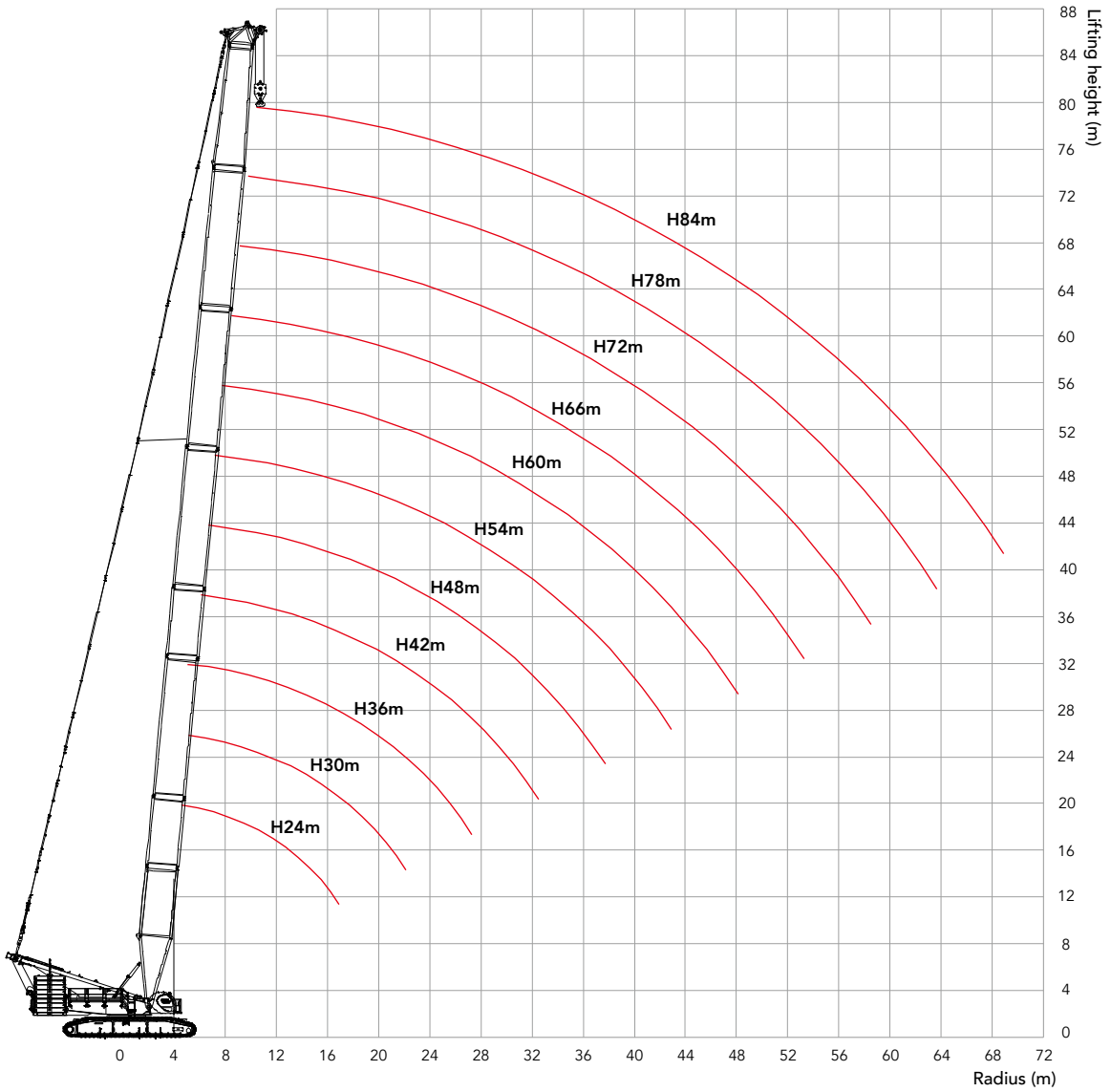

Unit: t

## Load Chart of H Configuration

Load Chart-H												
Boom length: 24~84m, Rear counterweight: 180t, Carbody counterweight: 50t												
Radius(m)	Boom length (m)											Radius(m)
	24	30	36	42	48	54	60	66	72	78	84	
6	480	450										6
7	426	422	418	414								7
8	369	366	363	354	335	317						8
9	325	323	320	307	292	278	266	254				9
10	290	288	283	271	259	248	237	228	218	210		10
11	262	260	252	242	232	223	214	206	198	191	184	11
12	236	235	227	218	210	202	195	188	181	174	168	12
14	188	187	186	182	176	170	164	159	153	148	144	14
16	155	155	154	153	150	146	141	137	133	129	124	16
18	131	131	131	130	129	127	124	120	116	113	109	18
20	113	113	113	113	112	111	109	106	103	100	97	20
22	99.3	99.6	99.1	98.8	98	97.2	96.3	95	92.2	89.5	86.8	22
24		88.3	88	87.7	86.9	86.3	85.3	84.5	83	80.6	78.1	24
26		79.1	78.8	78.6	77.8	77.2	76.3	75.5	74.5	73.1	70.8	26
28		71.3	71.1	70.9	70.2	69.6	68.7	67.9	67	66.1	64.4	28
30			64.5	64.4	63.7	63.2	62.3	61.5	60.6	59.7	58.7	30
32			58.9	58.8	58.2	57.6	56.7	56	55.1	54.2	53.2	32
34				53.9	53.3	52.7	51.9	51.2	50.3	49.4	48.5	34
36				49.6	49	48.5	47.7	47	46	45.2	44.2	36
38				45.8	45.2	44.7	43.9	43.2	42.3	41.5	40.5	38
40					41.9	41.4	40.6	39.9	39	38.1	37.2	40
44					36	35.6	34.8	34.1	33.2	32.5	31.5	44
48						30.8	30.1	29.4	28.5	27.8	26.8	48
52							26.1	25.5	24.6	23.8	22.9	52
56								22.1	21.3	20.5	19.6	56
60									18.4	17.6	16.7	60
64									15.8	15.1	14.2	64
68										12.9	12	68
72											10	72

## Boom Combination in HDB

### Boom Combination in HDB

Boom length(m)	Boom insert	
	6m/(H6)	12mA/(H8A)
24	-	-
30	1	-
36	2	-
42	1	1
48	2	1
54	1	2
60	2	2
66	1	3
72	2	3
78	1	4
84	2	4

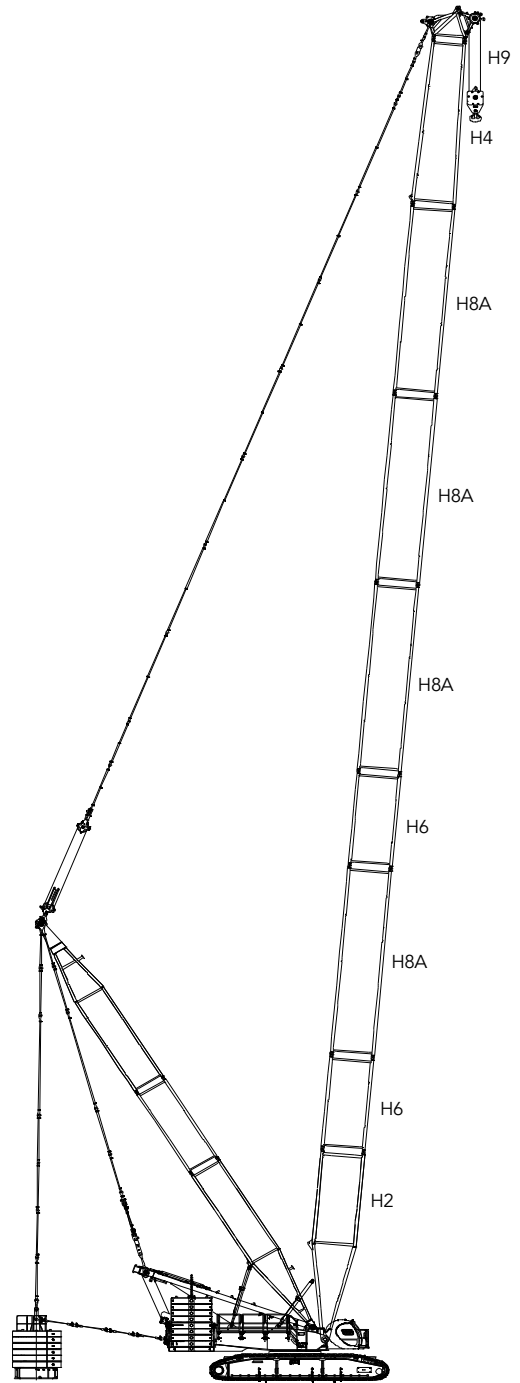

## Working Radius in HDB

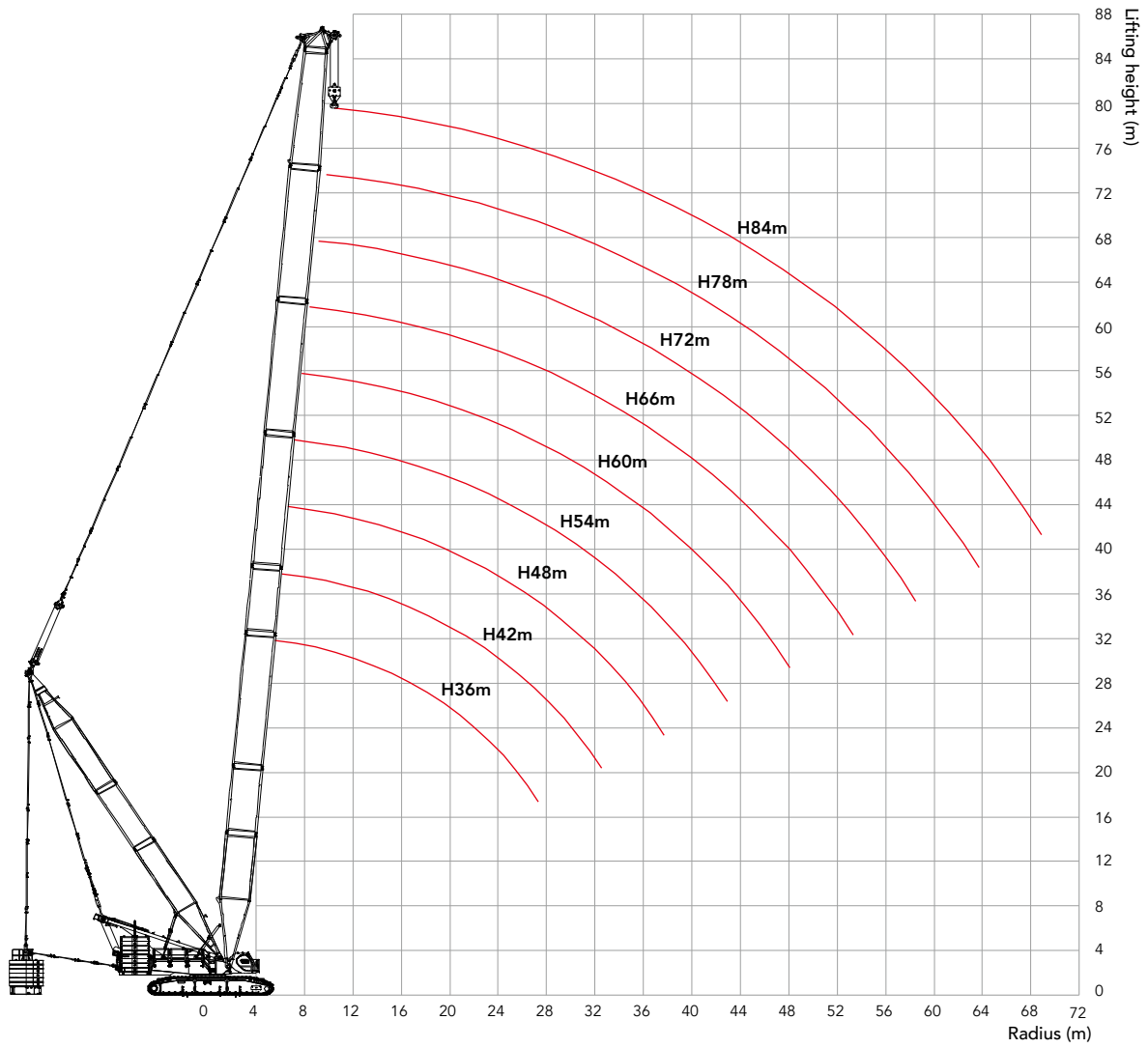

**Load Chart of HDB****Load Chart- HDB (Superlift counterweight 0t, Rear counterweight 180t)**

Boom length 36~84m, Superlift radius 15m, Carbody counterweight 50t

Radius(m)	Boom length (m)									Radius(m)
	36	42	48	54	60	66	72	78	84	
7	438	434								7
8	380	377	367	348						8
9	335	333	320	306	292	280				9
10	300	296	284	272	261	251	241	232		10
11	271	264	254	245	236	227	219	211	204	11
12	245	239	230	222	215	207	200	193	187	12
14	203	199	193	187	181	176	170	165	160	14
16	169	169	166	161	156	152	148	143	139	16
18	144	143	143	141	137	133	130	126	123	18
20	125	124	124	123	122	118	115	112	109	20
22	109	109	109	108	107	106	103	101	97.9	22
24	97.3	97.0	96.6	96.1	95.4	94.7	93.3	90.9	88.4	24
26	87.3	87.0	86.6	86.2	85.5	84.9	84.0	82.7	80.4	26
28	78.9	78.7	78.3	77.8	77.2	76.6	75.8	75.0	73.4	28
30	71.7	71.6	71.2	70.7	70.1	69.5	68.7	68.0	67.1	30
32	65.6	65.4	65.0	64.6	64.0	63.4	62.7	62.0	61.1	32
34		60.1	59.7	59.3	58.7	58.1	57.4	56.7	55.8	34
36		55.4	55.0	54.6	54.0	53.5	52.7	52.0	51.2	36
38		51.2	50.9	50.5	49.9	49.3	48.6	47.9	47.1	38
40			47.2	46.8	46.2	45.7	44.9	44.2	43.4	40
44			40.8	40.4	39.9	39.3	38.6	38.0	37.1	44
48				35.2	34.6	34.1	33.4	32.8	31.9	48
52					30.2	29.8	29.0	28.4	27.6	52
56						26.0	25.3	24.7	23.9	56
60							22.1	21.5	20.7	60
64							19.3	18.7	17.9	64
68								16.2	15.4	68
72									13.2	72

Unit: t

## Load Chart of HDB

Load Chart- HDB (Superlift counterweight: 250t, Rear counterweight: 140t)										
Boom length: 36~84m, Superlift radius: 15m, Carbody counterweight: 50t										
Radius(m)	Boom length (m)									Radius(m)
	36	42	48	54	60	66	72	78	84	
7	480*	450*								7
8	450*	450*	435*	404*						8
9	450*	450*	437*	405*	375*	341*				9
10	450*	450*	436*	403*	376*	341*	307*	258*		10
11	450	450	438	404*	378*	341*	307*	258*	219*	11
12	450	450	437	402	378	343*	307*	258*	218*	12
14	429	418	415	403	379	342	307	258*	218*	14
16	365	363	362	360	358	344	307	258	219*	16
18	322	321	320	318	316	315	307	258	219*	18
20	288	287	286	285	283	282	280	257	218	20
22	261	260	258	257	256	255	253	252	218	22
24	238	237	236	234	233	232	231	229	217	24
26	218	217	216	215	214	213	212	210	209	26
28	201	200	200	199	198	196	195	194	193	28
30	187	186	185	184	183	182	181	180	179	30
32	174	173	173	172	171	170	169	168	166	32
34		162	161	161	160	159	158	157	156	34
36		152	152	151	150	149	148	147	146	36
38		143	143	142	141	140	139	138	137	38
40			135	134	133	132	131	130	129	40
44			121	120	119	119	118	117	116	44
48				109	108	107	106	105	104	48
52					98.3	97.6	96.7	95.9	94.8	52
56						89.3	88.4	87.6	86.6	56
60							81.2	80.4	79.4	60
64							74.8	74.1	73.1	64
68								68.5	67.6	68
72									62.6	72

## Boom Combination in HJ

Boom Combination in HJ					
Boom length(m)	Boom insert			Jib insert	
	6m / (H6)	12mA / (H8A)	6mA / (LJ6A)	6mB / (LJ6B)	12m / (LJ7)
48	2	-	1	-	-
54	1	1	1	-	-
60	1	1	1	1	-
66	2	1	1	1	-
72*	2	1	1	-	1
78*	2	1	1	1	1
84*	1	2	1	1	1
90*	1	2	1	-	2
96*	2	2	1	-	2

Note: Combinations marked "\*" mean when boom length is 72m or more, the mid-point suspension cable is must, otherwise, the boom may break.

Attention: if the boom length is 84m or more, the crane must boom up from side by side erection outrigger, otherwise the crane may tip over.

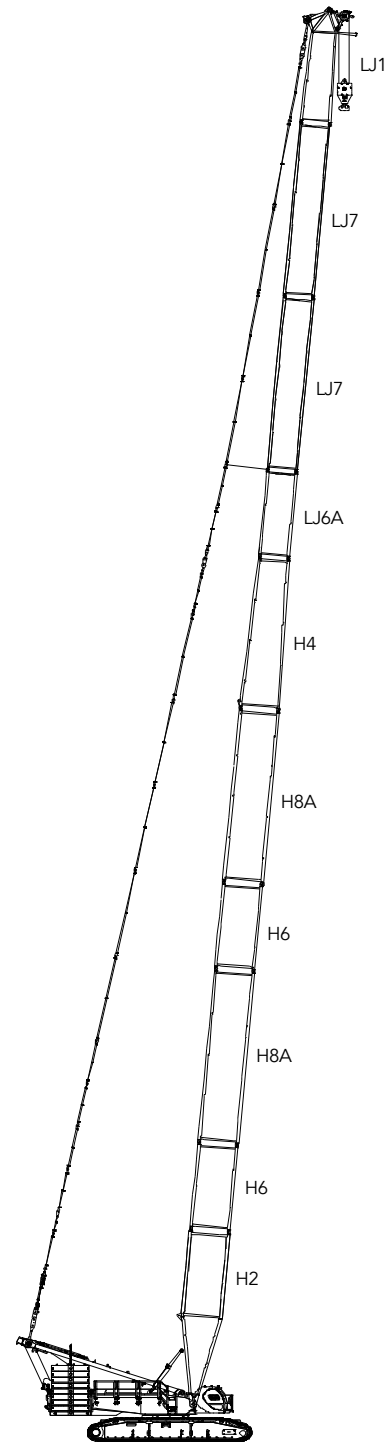



## Working Radius in HJ

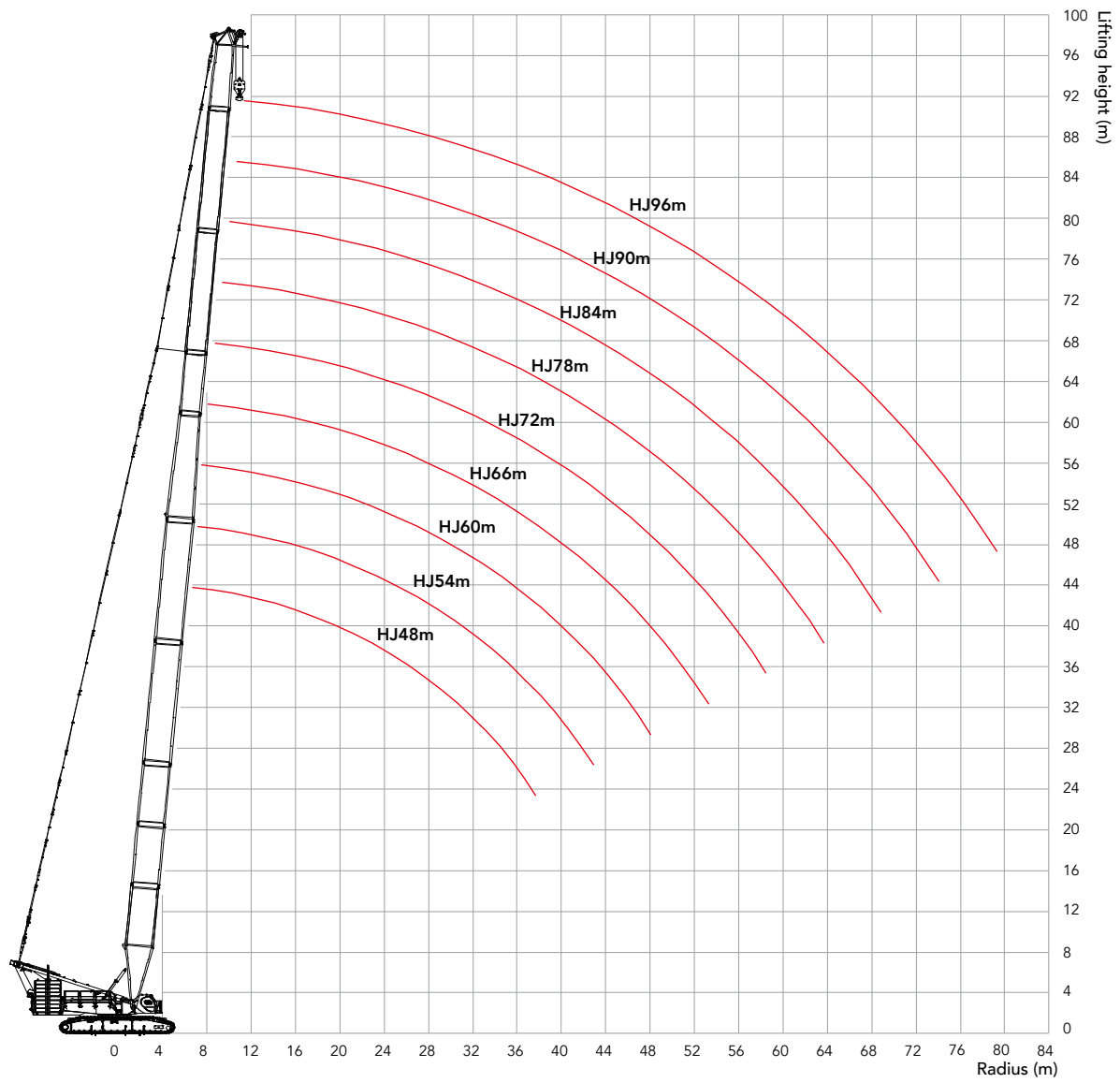

**Load Chart of HJ**

Load Chart- HJ										
Boom length: 48~96m, Rear counterweight: 180t, Carbody counterweight: 50t										
Radius(m)	Boom length (m)									Radius(m)
	48	54	60	66	72	78	84	90	96	
8	226	224								8
9	228	225	216	213						9
10	228	226	218	214	195	162				10
11	231	227	219	211	196	159	163	134		11
12	215	207	200	193	187	158	163	133	132	12
14	180	174	169	164	159	154	149	129	129	14
16	155	150	146	142	138	134	130	126	123	16
18	133	131	128	124	121	118	115	112	109	18
20	115	114	114	110	108	105	102	100	97.1	20
22	101	101	100	99	97	94.7	92	90	87.4	22
24	90.1	89.4	89	88	87.7	85.7	83.3	81.6	79.1	24
26	80.9	80.2	79.9	78.9	78.7	78	75.9	74.3	72	26
28	73.2	72.5	72.2	71.3	71	70.5	69.4	68	65.9	28
30	66.6	66	65.7	64.7	64.5	64	63.2	62.5	60.5	30
32	60.9	60.3	60.1	59.1	59	58.5	57.6	57.3	55.7	32
34	56	55.4	55.2	54.3	54.1	53.6	52.8	52.4	51.4	34
36	51.7	51.1	50.9	50	49.8	49.3	48.5	48.2	47.2	36
38	47.8	47.3	47.1	46.2	46	45.6	44.7	44.4	43.4	38
40	44.4	43.9	43.7	42.8	42.6	42.2	41.4	41.1	40.1	40
44		38.1	37.9	37	36.9	36.4	35.6	35.3	34.3	44
48		33.2	33.1	32.2	32.1	31.7	30.9	30.6	29.6	48
52			29	28.2	28.1	27.7	26.9	26.6	25.7	52
56				24.8	24.7	24.3	23.5	23.3	22.3	56
60					21.8	21.4	20.6	20.4	19.4	60
64					19.2	18.9	18.1	17.8	16.9	64
68						16.6	15.8	15.6	14.6	68
72							13.9	13.6	12.5	72
76								11.9	8.7	76
80								10.3	4.1	80

## Boom Combination in HJDB

Boom Combination in HJDB					
Boom length(m)	Boom insert		Jib insert		
	6m/(H6)	12mA/(H8A)	6mA/(LJ6A)	6mB/(LJ6B)	12m/(LJ7)
78	1	3	1	-	-
84	2	3	1	-	-
90*	1	4	1	-	-
96*	2	4	1	-	-
102*	2	4	1	1	-
108*	2	4	1	-	1
114*	2	4	1	1	1
120*	2	4	1	2	1
126*	2	4	1	1	2

Note: Combinations marked "\*" mean the mid-point suspension cable is must, otherwise, the boom may break.

The use of the mid-point suspension cable must be strictly in accordance to the instructions.

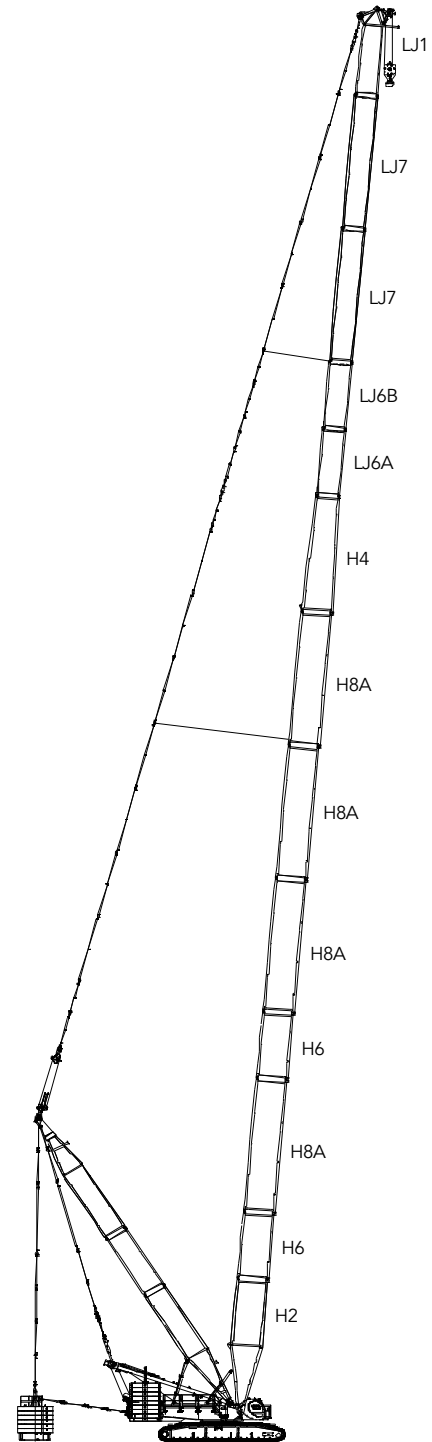

### Working Radius in HJDB

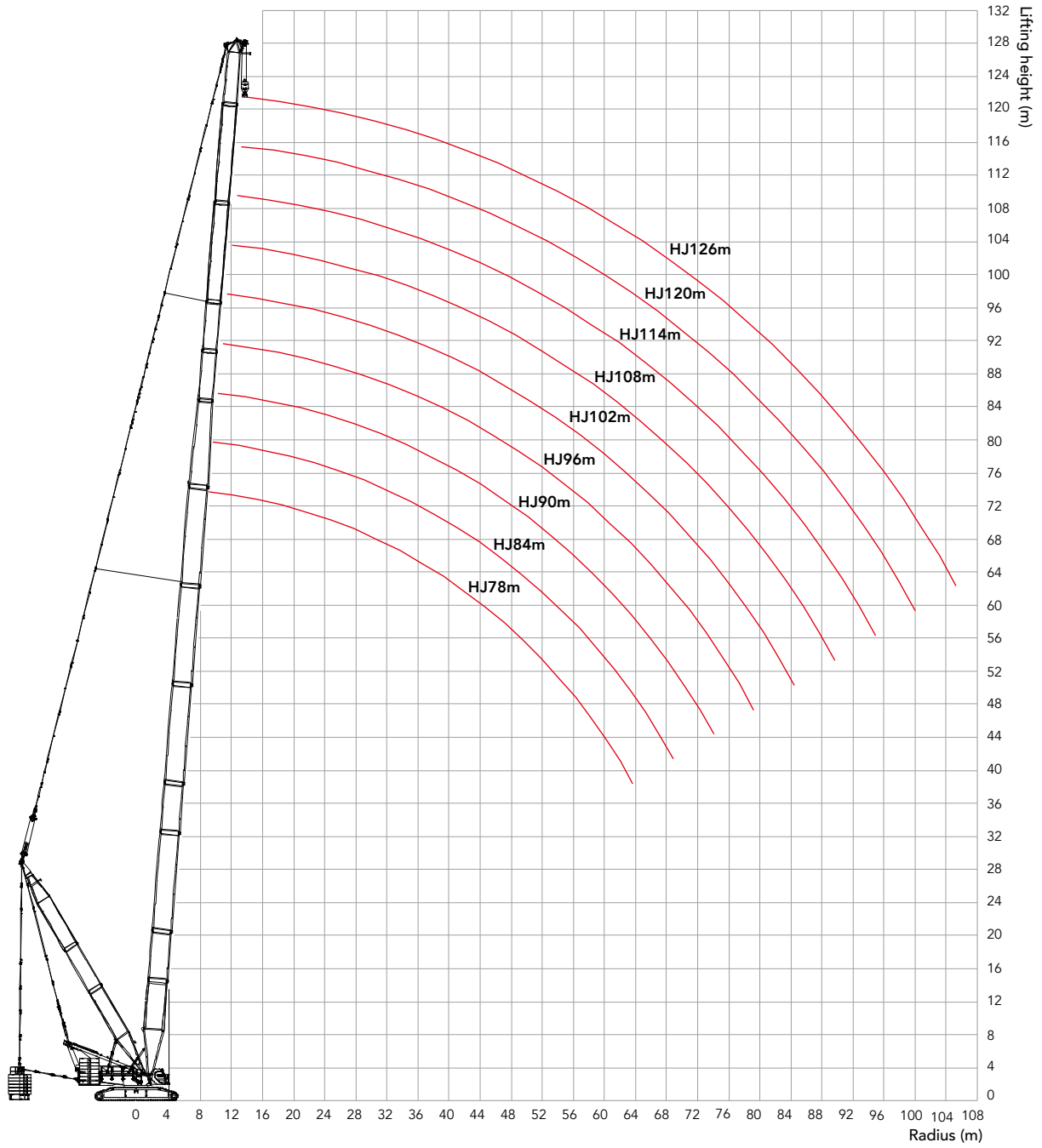

Unit: t

### Load Chart of HJDB

Load Chart- HJDB (Superlift counterweight 0t, Rear counterweight 180t)										
Boom length 78~126m, Superlift radius 15m, Carbody counterweight 50t										
Jib length Radius(m)	78	84	90	96	102	108	114	120	126	Jib length Radius(m)
10	215									10
11	213	205	188							11
12	195	189	182	162	140					12
14	167	162	157	152	140	123	107	92.7		14
16	145	141	137	133	129	123	107	92.5	80.4	16
18	128	124	121	117	115	112	106	92.2	79.6	18
20	114	111	108	105	102	100	98.0	91.8	78.7	20
22	102	99.6	97.0	94.3	92.2	90.5	88.4	86.4	77.9	22
24	92.7	90.2	87.9	85.4	83.6	82.0	80.2	78.3	76.8	24
26	84.4	82.2	80.0	77.7	76.1	74.7	73.1	71.4	70.0	26
28	76.6	75.2	73.2	71.1	69.6	68.4	66.9	65.3	64.1	28
30	69.6	68.7	67.2	65.3	63.9	62.8	61.4	60.0	58.8	30
32	63.6	62.7	61.9	60.1	58.8	57.9	56.6	55.2	54.2	32
34	58.3	57.4	56.6	55.5	54.3	53.4	52.2	51.0	50.0	34
36	53.6	52.8	52.0	51.1	50.3	49.5	48.3	47.1	46.2	36
38	49.5	48.7	47.9	47.0	46.6	45.9	44.8	43.7	42.8	38
40	45.8	45.0	44.2	43.3	43.0	42.7	41.6	40.5	39.7	40
44	39.6	38.7	38.0	37.1	36.7	36.6	36.0	35.0	34.3	44
48	34.4	33.6	32.8	31.9	31.6	31.4	31.0	30.3	29.7	48
52	30.0	29.2	28.5	27.6	27.3	27.1	26.7	26.2	25.7	52
56	26.3	25.5	24.8	23.9	23.6	23.5	23.0	22.6	22.3	56
60	23.1	22.3	21.6	20.7	20.4	20.3	19.8	19.4	19.1	60
64	20.3	19.5	18.8	17.9	17.6	17.5	17.1	16.6	16.4	64
68	17.8	17.0	16.4	15.5	15.2	15.1	14.7	14.2	14.0	68
72		14.8	14.2	13.3	13.0	12.9	12.5	12.0	11.8	72
76			12.2	11.4	11.0	11.0	10.6	10.1	9.9	76
80			10.4	9.6	9.3	9.2	8.8	8.4	8.1	80
84				8.0	7.7	7.6	7.2	6.8	6.6	84
88					6.2	6.2	5.8	5.4	5.1	88
92						4.9	4.5	4.0	3.8	92
96							3.3			96

**Load Chart of HJDB****Load Chart- HJDB (Superlift counterweight: 250t, Rear counterweight: 140t)**

Boom length: 78~126m, Superlift radius: 15m, Carbody counterweight: 50t

Jib length Radius(m)	78	84	90	96	102	108	114	120	126	Jib length Radius(m)
10	215*									10
11	216*	212*	188*							11
12	216*	211*	187*	162*	140*					12
14	218*	213*	188*	162*	140*	123*	107*	92.7*		14
16	219*	214*	187*	163*	140*	123*	107*	92.5*	80.4*	16
18	221*	216*	184*	163*	140*	123*	106*	92.2*	79.6*	18
20	222	218	179*	162*	140*	123*	106*	91.8*	78.7*	20
22	224	219	176*	162*	140*	122*	107*	90.9*	77.9*	22
24	226	218	172	162	141*	122*	106*	90.0*	77.0*	24
26	212	211	167	163	140*	122*	106*	89.1*	76.1*	26
28	196	194	161	162	140	122*	105*	88.1*	75.2*	28
30	182	180	152	162	140	122	104*	87.2*	74.3*	30
32	169	168	144	162	139	121	103*	86.2*	73.4*	32
34	158	157	137	155	134	120	103*	85.3*	72.4*	34
36	149	147	131	145	128	119	102	84.3*	71.5*	36
38	140	139	126	137	122	118	101	83.3*	70.6*	38
40	132	131	121	129	118	117	99.7	82.3*	69.7*	40
44	118	117	111	115	108	113	97.9	80.4	67.9*	44
48	107	106	104	104	101	103	96.1	77.4	65.8*	48
52	97.5	96.4	95.6	94.5	94.0	93.7	93.1	73.0	62.0	52
56	89.2	88.2	87.3	86.3	85.8	85.5	85.0	69.2	58.6	56
60	82.0	81.0	80.2	79.2	78.7	78.5	77.9	66.0	55.8	60
64	75.7	74.8	73.9	72.9	72.5	72.2	71.7	62.8	53.0	64
68	70.1	69.2	68.4	67.4	66.9	66.7	66.2	60.5	50.7	68
72		64.2	63.4	62.4	62.0	61.8	61.3	58.3	48.8	72
76			59.0	58.0	57.6	57.4	56.9	56.1	46.9	76
80			55.0	54.0	53.6	53.5	53.0	52.4	45.4	80
84				50.4	50.0	49.8	49.4	48.8	44.0	84
88					46.7	46.6	46.1	45.6	42.9	88
92						43.5	43.1	42.6	42.1	92
96							40.3	39.8	39.5	96
100							37.8	37.3	37.0	100
104								34.9	34.7	104
108									32.5	108

## Boom Combination in LJ(DB)

Boom Combination in LJ(DB)				
Boom length(m)	Boom insert			Boom length(m) (m)
	6 mA	6mB	12m	
24	1	-	-	36~60(LJ) 36~84(LJDB) 54m+72/60+66(LJ) longest boom+ longest jib 85° 75° 65°
30	1	1	-	
36	1	2	-	
42	1	1	1	
48	1	2	1	
54	1	1	2	
60	1	2	2	
66*	1	1	3	
72*	1	2	3	
78*	1	1	4	
84*	1	2	4	

Jib length in LJ: 24m~72m; Jib length in LJDB: 24m~84m

Note: Combinations marked\*\*\*mean for jib length 66m~84m, the mid-point suspension cable is must, otherwise, the boom may break.

Attention: In LJ configuration, the crane's booming up must be strictly in accordance to the instructions, otherwise the crane may tip over !

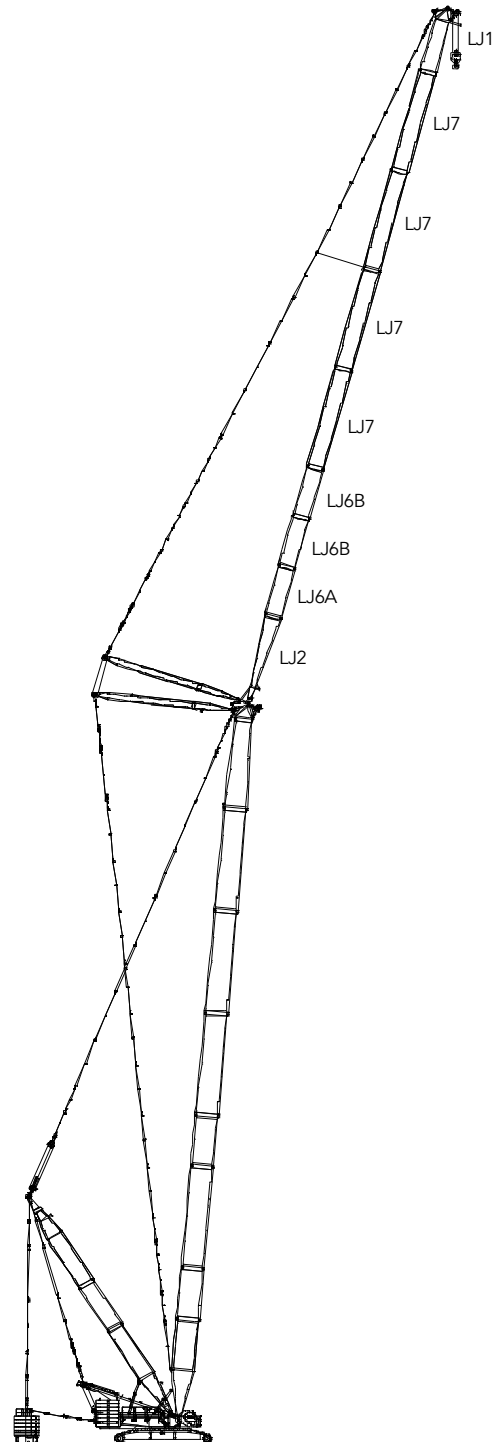

## Working Radius in LJ

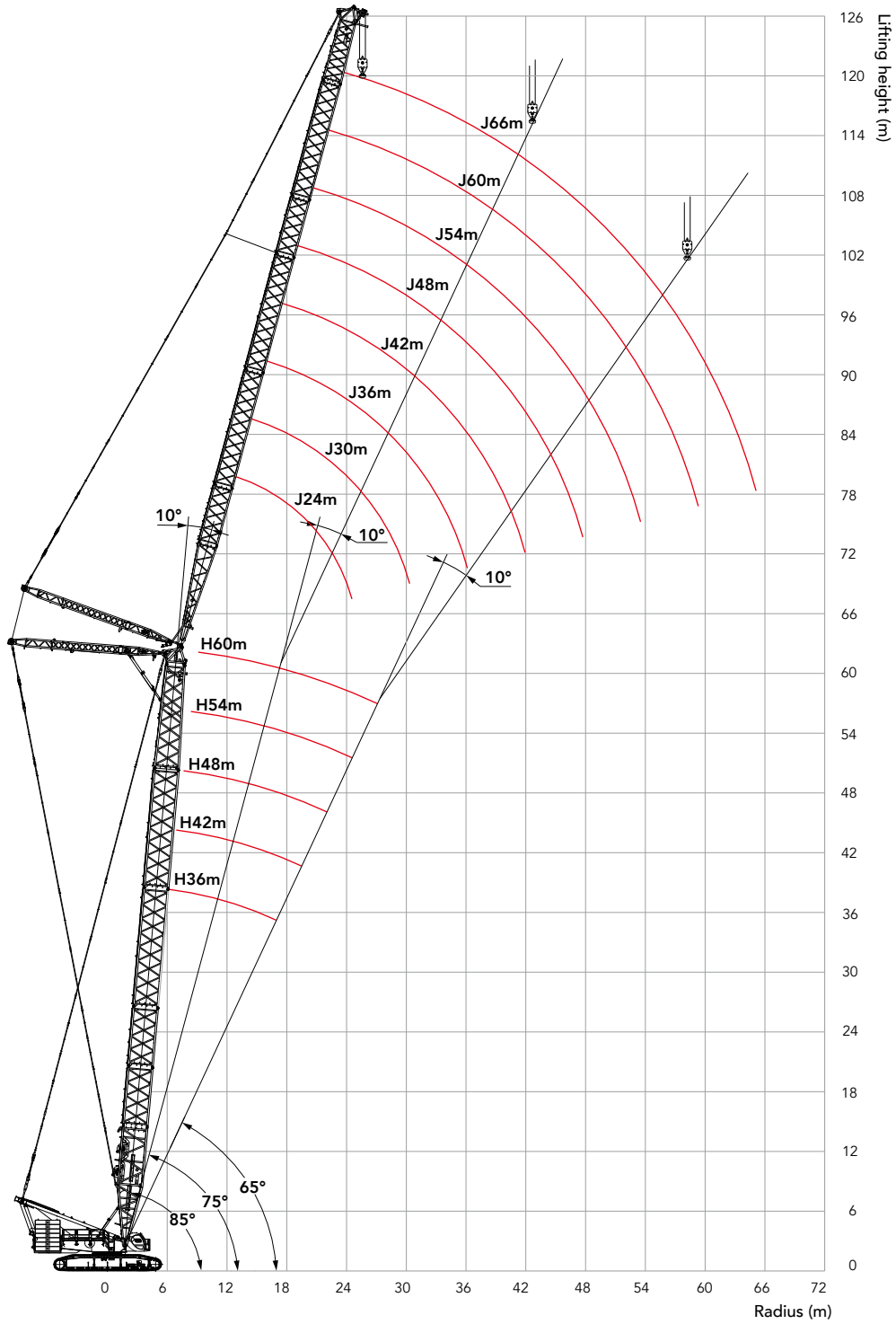



Unit: t

## Load Chart of LJ

Load Chart- LJ 1/5										
Boom length: 36m, Boom angle: 85°, Jib length: 24m~72m, Rear counterweight: 180t, Carbody counterweight: 50t										
Jib length Radius(m)	24	30	36	42	48	54	60	66	72	Jib length Radius(m)
14	177									14
16	154	150	145							16
18	133	133	129	125						18
20	117	116	115	113	110					20
22	104	103	102	101	99.7	97.2	94.6			22
24	93.1	92.6	91.8	91	90.2	89	86.6	83.3		24
26	84.3	83.9	83.2	82.5	81.7	81	79.8	77.8	70.1	26
28		76.6	75.9	75.3	74.6	73.9	73.1	72	69.3	28
30		70.3	69.8	69.2	68.5	67.9	67.1	66.5	65.1	30
32		64.9	64.4	63.9	63.2	62.6	61.9	61.3	60.5	32
34			59.8	59.3	58.6	58.1	57.3	56.7	56	34
36			55.7	55.2	54.6	54	53.3	52.8	52	36
38			52	51.6	51	50.5	49.8	49.2	48.5	38
40				48.4	47.8	47.3	46.6	46.1	45.4	40
44					42.3	41.9	41.2	40.7	40	44
48						37.8	37.4	36.7	36.2	48
52							33.6	33	32.5	52
56								29.8	29.3	56
60								27	26.5	60
64									24.1	64
68									21.4	68

**Load Chart of LJ**

Load Chart- LJ 2/5										
Boom length: 42m, Boom angle: 85°, Jib length: 24m~72m, Rear counterweight: 180t, Carbody counterweight: 50t										
Jib length Radius(m)	24	30	36	42	48	54	60	66	72	Jib length Radius(m)
14	170									14
16	149	145								16
18	132	129	125	121						18
20	116	115	112	109	106					20
22	103	102	101	99.5	96.8	94.4				22
24	92.5	91.8	91.1	90.3	88.7	86.5	84.2			24
26	83.7	83.3	82.5	81.8	81	79.7	77.6	75.6	65.7	26
28	76.3	76	75.4	74.7	74	73.3	71.8	70	64.2	28
30		69.8	69.3	68.7	67.9	67.3	66.5	65.1	62.7	30
32		64.5	64	63.4	62.7	62.1	61.4	60.7	59	32
34			59.4	58.8	58.2	57.6	56.9	56.2	55.2	34
36			55.3	54.8	54.2	53.6	52.9	52.3	51.6	36
38			51.7	51.2	50.6	50.1	49.4	48.8	48.1	38
40				48	47.4	46.9	46.2	45.7	45	40
44				42.5	42	41.5	40.9	40.3	39.6	44
48					37.5	37.1	36.4	35.9	35.2	48
52						33.3	32.7	32.2	31.5	52
56							29.5	29	28.4	56
60							26.7	26.3	25.7	60
64								23.9	23.3	64
68									21.2	68

Unit: t

## Load Chart of LJ

Load Chart- LJ 3/5										
Boom length: 48m, Boom angle: 85°, Jib length: 24m~72m, Rear counterweight: 180t, Carbody counterweight: 50t										
Jib length Radius(m)	24	30	36	42	48	54	60	66	72	Jib length Radius(m)
14	164									14
16	144	140								16
18	128	124	121							18
20	115	112	109	106	103					20
22	102	101	99.2	96.6	94	91.6				22
24	91.8	91.2	90.4	88.6	86.2	84	81.3			24
26	83.2	82.7	81.9	81.2	79.5	77.5	75.4	69.6		26
28	75.9	75.5	74.8	74.2	73.4	71.8	69.9	67.5	59.4	28
30		69.4	68.8	68.2	67.4	66.8	65	63.3	58	30
32		64.1	63.5	63	62.2	61.6	60.7	59.1	56.3	32
34		59.4	59	58.4	57.7	57.2	56.4	55.3	53.7	34
36			54.9	54.4	53.8	53.2	52.5	51.9	50.4	36
38			51.3	50.9	50.3	49.7	49	48.4	47.4	38
40				47.7	47.1	46.6	45.9	45.3	44.6	40
44				42.2	41.7	41.2	40.6	40	39.3	44
48					37.2	36.8	36.2	35.6	34.9	48
52						33.1	32.5	31.9	31.3	52
56							29.3	28.8	28.1	56
60							26.5	26.1	25.4	60
64								23.7	23.1	64
68									21	68
72									19.1	72

**Load Chart of LJ**

Load Chart- LJ 4/5										
Boom length: 54m, Boom angle: 85°, Jib length: 24m~72m, Rear counterweight: 180t, Carbody counterweight: 50t										
Jib length Radius(m)	24	30	36	42	48	54	60	66	72	Jib length Radius(m)
16	139	135								16
18	124	120	117							18
20	112	109	106	103						20
22	101	98.9	96.2	93.7	91.1					22
24	91	90.4	88.2	86	83.6	81.5	74.4			24
26	82.5	82	81.2	79.3	77.1	75.2	72.1	64.1		26
28	75.3	74.9	74.2	73.5	71.5	69.8	67.8	62.2	54.9	28
30		68.8	68.2	67.5	66.6	64.9	63.1	60.2	53.5	30
32		63.6	63	62.4	61.7	60.7	58.9	57.4	51.9	32
34		58.9	58.5	57.9	57.2	56.6	55.2	53.7	50.3	34
36			54.5	54	53.3	52.7	51.9	50.5	48.3	36
38			50.9	50.5	49.8	49.2	48.5	47.5	46	38
40				47.3	46.7	46.2	45.4	44.8	43.3	40
44				41.9	41.3	40.8	40.2	39.6	38.7	44
48					36.9	36.5	35.8	35.3	34.6	48
52						32.8	32.1	31.6	30.9	52
56						29.6	29	28.5	27.8	56
60							26.3	25.8	25.2	60
64								23.4	22.8	64
68									20.8	68
72									18.9	72

Unit: t

## Load Chart of LJ

Load Chart- LJ 5/5									
Boom length: 60m, Boom angle: 85°, Jib length: 24m~66m, Rear counterweight: 180t, Carbody counterweight: 50t									
Jib length Radius(m)	24	30	36	42	48	54	60	66	Jib length Radius(m)
16	134								16
18	120	116	113						18
20	108	105	102	99.4					20
22	98.5	95.8	93.2	90.7	88.2				22
24	90.3	88	85.5	83.3	81	76.5			24
26	81.8	81.2	79	77	74.8	72.9	65.5	58.7	26
28	74.7	74.2	73.3	71.4	69.4	67.6	63.3	56.8	28
30		68.2	67.6	66.6	64.7	63	60.6	55	30
32		63	62.4	61.8	60.5	58.9	57.2	52.8	32
34		58.5	58	57.4	56.7	55.2	53.6	50.9	34
36			54	53.5	52.8	51.9	50.3	48.7	36
38			50.5	50	49.3	48.8	47.4	46.1	38
40			47.3	46.9	46.3	45.7	44.7	43.5	40
44				41.5	41	40.5	39.8	38.9	44
48					36.6	36.1	35.4	34.9	48
52						32.4	31.8	31.3	52
56						29.3	28.7	28.2	56
60							26	25.5	60
64								22.9	64
68									68
72									72

## Working Radius in LJDB

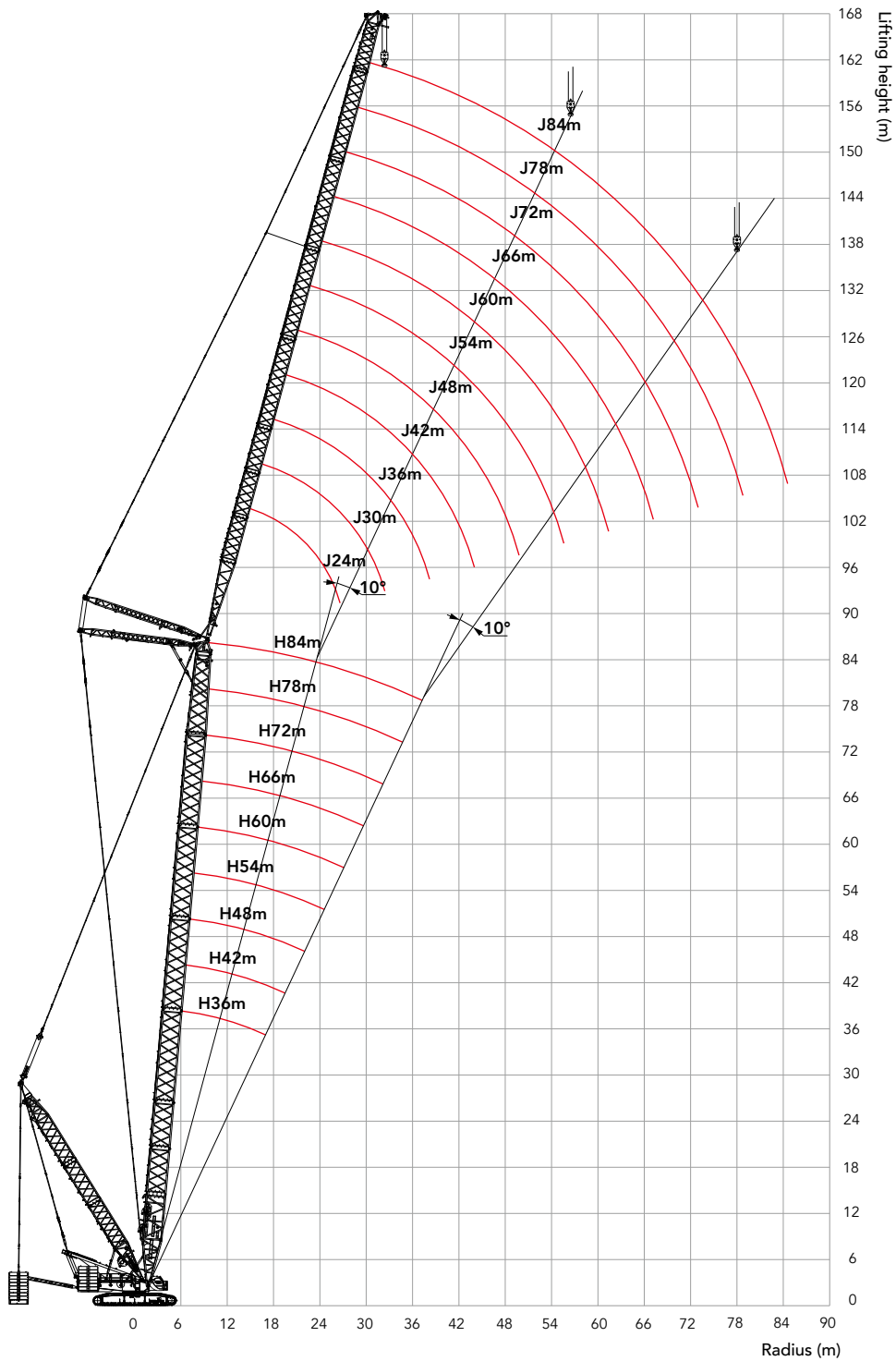

Unit: t

## Load Chart of LJDB

Load Chart- LJDB (Superlift counterweight 0t, Rear counterweight 180t)												
Boom length 36m, Boom angle 85°, Jib length 24~84m, Superlift radius 15m, Carbody counterweight 50t												
Jib length Radius(m)	24	30	36	42	48	54	60	66	72	78	84	Jib length Radius(m)
14	199											14
16	174	169	164									16
18	154	150	146	142								18
20	138	135	131	128	124							20
22	124	122	119	116	113	110	99.0					22
24	111	111	109	106	104	101	97.4	84.2				24
26	101	100	99.5	97.9	95.4	93.3	90.9	82.8	70.4			26
28		91.6	90.8	90.1	88.4	86.4	84.2	81.0	69.8	59.5		28
30		84.1	83.5	82.8	81.9	80.4	78.4	76.6	68.7	59.1	49.7	30
32		77.7	77.1	76.5	75.6	75.0	73.2	71.5	67.1	58.6	49.2	32
34			71.6	70.9	70.2	69.5	68.6	67.0	65.3	57.9	48.8	34
36			66.6	66.1	65.3	64.7	63.9	63.0	61.3	56.9	48.4	36
38			62.3	61.8	61.1	60.5	59.7	59.0	57.7	55.8	48.0	38
40				57.9	57.3	56.7	55.9	55.2	54.4	53.1	47.6	40
44					50.7	50.2	49.4	48.8	48.0	47.3	45.8	44
48					45.3	44.8	44.1	43.5	42.7	42.0	41.2	48
52						40.3	39.6	39.0	38.2	37.6	36.8	52
56							35.7	35.2	34.4	33.8	33.0	56
60							32.4	31.9	31.2	30.5	29.8	60
64								29.0	28.3	27.7	27.0	64
68									25.8	25.2	24.5	68
72										23.0	22.2	72
76										21.0	20.3	76
80											18.5	80

**Load Chart of LJDB**

Load Chart- LJDB (Superlift counterweight 0t, Rear counterweight 180t)												
Boom length 42m, Boom angle 85°, Jib length 24~84 m, Superlift radius 15m, Carbody counterweight 50t												
Jib length Radius(m)	24	30	36	42	48	54	60	66	72	78	84	Jib length Radius(m)
14	193											14
16	169	164										16
18	150	146	142	138								18
20	135	131	128	124	121							20
22	122	119	116	113	110	108						22
24	111	109	106	104	101	98.8	91.2					24
26	100	99.9	98.1	95.7	93.3	91.2	88.8	77.7	66.4			26
28	91.6	91.2	90.5	88.7	86.5	84.5	82.4	76.1	66.1	56.2		28
30		83.8	83.2	82.4	80.5	78.7	76.7	74.5	64.7	55.8	47.0	30
32		77.4	76.8	76.1	75.3	73.6	71.7	70.0	63.2	55.5	46.7	32
34			71.3	70.7	69.9	69.0	67.2	65.6	61.8	54.9	46.3	34
36			66.4	65.9	65.1	64.4	63.2	61.7	60.0	53.7	46.0	36
38			62.1	61.6	60.8	60.2	59.4	58.1	56.5	52.4	45.7	38
40				57.7	57.0	56.4	55.6	54.9	53.4	51.2	45.1	40
44				51.1	50.5	50.0	49.2	48.5	47.7	46.5	43.2	44
48					45.1	44.6	43.9	43.3	42.5	41.8	40.6	48
52						40.1	39.4	38.8	38.0	37.4	36.6	52
56							35.6	35.0	34.3	33.6	32.8	56
60							32.3	31.7	31.0	30.4	29.6	60
64								28.9	28.2	27.6	26.8	64
68									25.7	25.1	24.3	68
72										22.8	22.1	72
76										20.8	20.1	76
80											18.4	80



Unit: t

## Load Chart of LJDB

Load Chart- LJDB (Superlift counterweight 0t, Rear counterweight 180t)												
Boom length 48m, Boom angle 85°, Jib length 24~84 m, Superlift radius 15m, Carbody counterweight 50t												
Jib length Radius(m)	24	30	36	42	48	54	60	66	72	78	84	Jib length Radius(m)
14	186											14
16	164	159										16
18	146	142	138									18
20	131	128	124	121	118							20
22	119	116	113	110	107	100						22
24	109	107	104	101	98.7	96.3	84.9					24
26	100	98.3	95.8	93.5	91.1	89.0	82.7	72.5				26
28	91.3	90.8	88.8	86.7	84.5	82.5	80.4	71.1	61.7	52.7		28
30		83.5	82.7	80.8	78.7	76.9	74.9	69.2	60.7	52.5	44.3	30
32		77.1	76.5	75.6	73.6	71.9	70.0	67.3	59.4	52.2	44.0	32
34		71.5	71.0	70.3	69.1	67.5	65.7	64.1	57.8	51.4	43.8	34
36			66.1	65.5	64.7	63.5	61.8	60.3	56.1	50.3	43.5	36
38			61.8	61.3	60.5	59.9	58.3	56.8	54.5	49.2	43.2	38
40				57.5	56.7	56.1	55.1	53.7	52.2	47.8	42.3	40
44				50.9	50.3	49.7	48.9	48.2	46.8	45.0	40.3	44
48					44.9	44.4	43.6	43.0	42.2	41.0	38.0	48
52						39.9	39.2	38.6	37.8	37.1	35.8	52
56							35.4	34.8	34.1	33.4	32.5	56
60							32.1	31.6	30.8	30.2	29.4	60
64								28.7	28.0	27.4	26.6	64
68									25.5	24.9	24.1	68
72									23.2	22.7	21.9	72
76										20.7	20.0	76
80											18.2	80

**Load Chart of LJDB**

Load Chart- LJDB (Superlift counterweight 0t, Rear counterweight 180t)												
Boom length 54m, Boom angle 85°, Jib length 24~84 m, Superlift radius 15m, Carbody counterweight 50t												
Jib length Radius(m)	24	30	36	42	48	54	60	66	72	78	84	Jib length Radius(m)
16	158	153										16
18	141	137	133									18
20	127	124	121	118								20
22	116	113	110	107	104							22
24	106	104	101	98.5	95.9	90.1	78.7					24
26	98.2	95.7	93.2	91.0	88.6	86.5	76.8	67.6				26
28	90.7	88.8	86.5	84.5	82.3	80.4	74.7	66.3	57.8			28
30		82.9	80.7	78.8	76.7	74.9	72.2	64.6	56.7	49.1	41.5	30
32		76.6	75.5	73.7	71.8	70.1	68.2	62.5	55.2	48.9	41.3	32
34		71.0	70.5	69.2	67.4	65.8	64.0	60.7	54.1	48.2	41.1	34
36			65.7	65.0	63.4	61.9	60.2	58.6	52.3	47.2	40.9	36
38			61.4	60.8	59.9	58.5	56.8	55.4	50.7	45.9	40.7	38
40				57.0	56.3	55.3	53.7	52.3	49.2	44.6	39.8	40
44				50.5	49.9	49.3	48.3	47.0	45.6	41.8	37.6	44
48					44.6	44.0	43.3	42.5	41.1	39.0	35.4	48
52						39.6	38.9	38.3	37.3	36.1	33.0	52
56						35.8	35.1	34.5	33.7	32.9	30.7	56
60							31.8	31.3	30.5	29.9	28.6	60
64								28.5	27.7	27.1	26.2	64
68									25.2	24.6	23.9	68
72									23.0	22.5	21.7	72
76										20.5	19.8	76
80											18.0	80

Unit: t

## Load Chart of LJDB

Load Chart- LJDB (Superlift counterweight 0t, Rear counterweight 180t)												
Boom length 60m, Boom angle 85°, Jib length 24~84 m, Superlift radius 15m, Carbody counterweight 50t												
Jib length Radius(m)	24	30	36	42	48	54	60	66	72	78	84	Jib length Radius(m)
16	153											16
18	137	133	129									18
20	124	120	117	114								20
22	113	110	107	104	97.1							22
24	103	101	98.1	95.7	93.2	82.9						24
26	95.6	93.1	90.7	88.5	86.2	80.2	70.9	62.8				26
28	88.8	86.5	84.2	82.2	80.0	77.4	69.0	61.3	53.6			28
30		80.7	78.6	76.7	74.7	72.9	66.7	59.7	52.6	45.8		30
32		75.6	73.6	71.8	69.9	68.2	64.3	57.7	51.6	45.6	38.5	32
34		70.5	69.2	67.5	65.7	64.1	61.5	56.1	49.9	44.7	38.3	34
36			65.2	63.6	61.8	60.3	58.6	53.8	48.5	43.8	38.2	36
38			60.9	60.1	58.4	57.0	55.3	51.7	46.8	42.4	37.8	38
40			57.1	56.6	55.3	53.9	52.3	49.7	45.1	41.2	36.8	40
44				50.2	49.5	48.5	47.0	45.4	41.7	38.5	34.7	44
48					44.2	43.7	42.6	41.1	38.4	35.7	32.7	48
52						39.3	38.5	37.2	35.1	33.1	30.2	52
56						34.9	34.5	33.4	31.9	30.3	28.1	56
60							30.6	30.0	28.8	27.6	25.8	60
64								26.8	26.0	25.0	23.7	64
68									23.5	22.8	21.7	68
72									20.9	20.6	19.7	72
76										18.6	17.8	76
80											16.2	80
84											14.7	84

**Load Chart of LJDB**

Load Chart- LJDB (Superlift counterweight 0t, Rear counterweight 180t)												
Boom length 66m, Boom angle 85°, Jib length 24~84 m, Superlift radius 15m, Carbody counterweight 50t												
Jib length Radius(m)	24	30	36	42	48	54	60	66	72	78	84	Jib length Radius(m)
16	147											16
18	132	128										18
20	120	116	113	103								20
22	109	106	103	99.6	88.7							22
24	100	97.8	95.2	92.8	85.6	76.1						24
26	92.9	90.5	88.1	85.9	81.9	73.5	65.3					26
28	86.4	84.1	81.9	79.9	77.7	70.9	63.6	56.8	49.5			28
30	80.7	78.5	76.4	74.6	72.5	68.2	61.4	55.1	49.2	42.3		30
32		73.6	71.6	69.9	68.0	65.1	59.2	53.5	47.9	42.1	35.7	32
34		69.2	67.3	65.7	63.8	61.9	56.9	51.7	46.3	41.8	35.5	34
36			63.5	61.9	60.2	58.7	54.3	49.8	45.0	40.7	35.4	36
38			60.0	58.5	56.8	55.4	52.0	47.9	43.4	39.3	35.0	38
40			56.6	55.4	53.8	52.4	49.4	45.7	41.8	38.2	34.1	40
44				49.7	48.5	47.0	44.5	41.9	38.7	35.5	32.2	44
48					42.5	41.4	39.8	37.9	35.5	33.1	30.1	48
52						36.5	35.5	34.3	32.1	30.4	28.0	52
56						32.3	31.8	30.7	29.3	27.8	25.8	56
60							28.2	27.5	26.3	25.2	23.6	60
64								24.5	23.7	22.8	21.6	64
68								21.9	21.4	20.8	19.7	68
72									19.2	18.6	17.9	72
76										16.8	16.1	76
80											14.6	80
84											13.2	84

Unit: t

## Load Chart of LJDB

Load Chart- LJDB (Superlift counterweight 0t, Rear counterweight 180t)												
Boom length 72m, Boom angle 85°, Jib length 24~84 m, Superlift radius 15m, Carbody counterweight 50t,												
Jib length Radius(m)	24	30	36	42	48	54	60	66	72	78	84	Jib length Radius(m)
16	142											16
18	128	124										18
20	116	113	106									20
22	106	103	100	90.6								22
24	97.4	94.9	92.3	86.8	78.0	69.6						24
26	90.2	87.8	85.5	82.4	75.0	67.2	60.1					26
28	83.9	81.7	79.5	77.6	71.4	65.1	58.4	52.2				28
30	78.4	76.3	74.3	72.4	68.2	62.2	56.3	50.8	45.1	38.7		30
32		71.6	69.6	67.9	64.5	59.6	54.2	49.1	44.0	38.6	32.6	32
34		67.4	65.5	63.8	60.9	56.6	52.1	47.3	42.8	38.5	32.5	34
36		63.6	61.8	60.2	57.3	53.6	49.6	45.8	41.3	37.5	32.4	36
38			58.4	56.8	53.8	51.0	47.5	43.7	40.0	36.2	32.2	38
40			54.6	52.8	50.7	48.1	45.3	41.9	38.3	35.2	31.5	40
44				45.8	44.5	42.7	40.5	38.1	35.3	32.6	29.6	44
48					39.0	37.9	36.4	34.5	32.3	30.1	27.6	48
52					34.0	33.3	32.4	31.1	29.3	27.6	25.4	52
56						29.4	28.9	27.7	26.4	25.1	23.4	56
60							25.6	24.7	23.9	22.9	21.3	60
64								22.2	21.5	20.7	19.3	64
68								19.8	19.3	18.6	17.7	68
72									17.2	16.6	16.0	72
76										15.1	14.3	76
80											13.0	80
84											11.6	84

**Load Chart of LJDB**

Load Chart- LJDB (Superlift counterweight 0t, Rear counterweight 180t)												
Boom length 78m, Boom angle 85°, Jib length 24~84 m, Superlift radius 15m, Carbody counterweight 50t												
Jib length Radius(m)	24	30	36	42	48	54	60	66	72	78	84	Jib length Radius(m)
18	123	112										18
20	112	106	95.1									20
22	103	99.7	91.4	82.4								22
24	94.4	91.9	86.9	78.9	70.8							24
26	87.5	85.2	81.8	75.3	68.4	61.5	55.2					26
28	81.4	79.3	77.1	71.2	65.5	59.5	53.7	47.9				28
30	76.1	74.1	72.1	67.5	62.2	57.1	51.7	46.6	40.9			30
32		69.5	67.5	63.4	59.2	54.7	49.8	45.2	40.5	35.0	29.6	32
34		65.4	62.9	59.9	55.8	51.9	47.8	43.6	39.4	34.8	29.5	34
36		61.4	58.5	56.0	52.8	49.4	45.7	41.9	38.0	34.4	29.3	36
38			54.8	52.2	49.6	47.0	43.7	40.2	36.6	33.4	29.2	38
40			50.8	49.0	46.8	44.3	41.7	38.5	35.4	32.3	29.0	40
44				42.6	41.4	39.6	37.4	35.1	32.5	30.0	27.2	44
48					36.4	35.1	33.5	31.8	29.7	27.6	25.1	48
52					31.9	30.9	29.8	28.6	26.9	25.4	23.3	52
56						27.4	26.6	25.5	24.2	23.0	21.6	56
60							23.9	23.0	21.8	20.7	19.5	60
64								20.8	19.7	18.9	17.7	64
68								19.0	17.9	16.9	16.0	68
72									16.3	15.3	14.4	72
76										13.9	13.0	76
80										12.6	11.6	80
84											10.5	84

Unit: t

## Load Chart of LJDB

Load Chart- LJDB (Superlift counterweight 0t, Rear counterweight 180t)												
Boom length 84m, Boom angle 85°, Jib length 24~84 m, Superlift radius 15m, Carbody counterweight 50t												
Jib length Radius(m)	24	30	36	42	48	54	60	66	72	78	84	Jib length Radius(m)
18	111											18
20	106	95.8	85.7									20
22	99.2	90.8	82.3	74.1								22
24	91.4	85.7	78.7	71.4	64.5							24
26	84.8	80.6	74.6	68.5	62.3	56.1						26
28	78.9	75.1	70.0	65.1	59.5	54.2	49.0	42.9				28
30	73.8	70.4	66.0	61.3	56.8	52.0	47.2	42.6	36.6			30
32		65.4	61.6	57.9	54.0	49.7	45.4	41.2	36.4	31.3		32
34		60.8	57.8	54.7	51.2	47.4	43.7	39.8	35.9	31.1	26.4	34
36		56.5	53.8	51.1	48.2	45.1	41.8	38.5	34.8	30.9	26.2	36
38			50.0	48.0	45.5	42.8	39.9	36.6	33.5	30.5	26.0	38
40			46.8	44.9	42.9	40.6	38.0	35.3	32.2	29.6	25.8	40
44				39.4	37.9	36.2	34.1	32.8	29.6	27.3	24.7	44
48				34.5	33.4	32.1	30.7	29.5	28.0	25.1	22.9	48
52					30.0	29.0	27.7	26.6	25.4	23.6	21.1	52
56						26.4	25.2	24.1	22.9	21.8	19.7	56
60							22.9	21.9	20.7	19.7	18.5	60
64							20.9	20.0	18.8	17.8	16.6	64
68								18.2	17.1	16.1	14.9	68
72									15.5	14.6	13.4	72
76										13.2	12.1	76
80										11.9	10.8	80
84											9.7	84

**Load Chart of LJDB****Load Chart- LJDB (Superlift counterweight: 250t, Rear counterweight: 140t)****Boom length: 36m, Boom angle: 85°, Jib length: 24m~84m, Superlift radius:15m, Carbody counterweight: 50t**

Jib length Radius(m)	24	30	36	42	48	54	60	66	72	78	84	Jib length Radius(m)
14	233*											14
16	229*	212*	189*									16
18	224*	210*	189*	156*								18
20	210*	200*	188*	156*	134*							20
22	194	188	177*	156*	132*	116*	99*					22
24	193	188	174	156*	130*	114*	97.4*	84.2*				24
26	175	178	162	151*	127*	111*	95.2*	82.8*	70.4*			26
28		163	152	143*	126*	107*	93*	81*	69.8*	59.5*		28
30		149	142	136*	125*	104*	90.2*	79.2*	68.7*	59.1*	49.7*	30
32		133	135	130*	124*	102*	87.5*	77.4*	67.1*	58.6*	49.2*	32
34			129	124	119*	101*	84.7*	75.5*	65.9*	57.9*	48.8*	34
36			118	119*	114*	101*	83*	73.3*	64.3*	56.9*	48.4*	36
38			107	111*	109*	96.9*	82.3*	71*	62.7*	55.8*	48*	38
40				102*	105*	92.4*	81.1*	68.8*	60.9*	54.5*	47.6*	40
44					90.8*	84.8*	73.8*	64*	57.5*	52.1*	45.8*	44
48					82.1*	77.3*	67.2*	59.3*	54.2*	49.2*	43.7*	48
52						70.8*	61.3*	54.7*	50.2*	46.4*	41.6*	52
56							55.9*	49.9*	46.7*	43.4*	39.4*	56
60							51.7*	45.6*	43*	40.5*	36.4*	60
64								41.4*	39.6*	37.8*	33*	64
68									36.5*	35.1*	29.8*	68
72										32.4*	26.6*	72
76										29.7*	23.7*	76
80											21.3*	80



Unit: t

## Load Chart of LJDB

Load Chart- LJDB (Superlift counterweight: 250t, Rear counterweight: 140t)												
Boom length: 42m, Boom angle: 85°, Jib length: 24m~84m, Superlift radius:15m, Carbody counterweight: 50t												
Jib length Radius(m)	24	30	36	42	48	54	60	66	72	78	84	Jib length Radius(m)
14	229*											14
16	227*	205*										16
18	222*	205*	174*	147*								18
20	208*	197*	174*	144*	129*							20
22	194	185*	173*	143*	126*	109*						22
24	188	175	167*	143*	122*	106*	91.2*					24
26	173	165	157*	142*	117*	103*	88.8*	77.7*	66.4*			26
28	163	156	150*	140*	116*	99.2*	86.8*	76.1*	66.1*	56.2*		28
30		148	142*	137*	116*	96*	84.3*	74.5*	64.7*	55.8*	47*	30
32		139*	136*	130*	115*	95.5*	81.8*	72.4*	63.2*	55.5*	46.7*	32
34			130*	122*	113*	94.8*	78.8*	70.3*	61.8*	54.9*	46.3*	34
36			121*	116*	108*	94*	78.3*	68.3*	60.4*	53.7*	46*	36
38			111*	109*	102*	93.3*	77.7*	66.2*	58.6*	52.4*	45.7*	38
40				102*	96.9*	90.8*	77.1*	64.1*	57.2*	51.2*	45.1*	40
44				90.1*	87.2*	82.4*	74.4*	63.1*	53.7*	48.5*	43.2*	44
48					77.7*	74.7*	67.6*	58.1*	49.9*	45.8*	40.9*	48
52						67.8*	61.9*	52.5*	46.2*	42.9*	38.9*	52
56							56.3*	47.9*	42.6*	39.9*	36.4*	56
60							51.8*	43.8*	39.2*	37.2*	34*	60
64								40*	35.9*	34.3*	31.8*	64
68									32.7*	31.6*	29.5*	68
72										28.9*	27*	72
76										26.6*	24.2*	76
80											21.8*	80

**Load Chart of LJDB****Load Chart- LJDB (Superlift counterweight: 250t, Rear counterweight: 140t)****Boom length: 48m, Boom angle: 85°, Jib length: 24m~84m, Superlift radius:15m, Carbody counterweight: 50t**

Jib length Radius(m)	24	30	36	42	48	54	60	66	72	78	84	Jib length Radius(m)
14	224*											14
16	221*	190*										16
18	216*	190*	167*									18
20	202*	190*	159*	138*	119*							20
22	190*	181*	156*	133*	116*	100*						22
24	179*	171*	154*	130*	112*	97.2*	84.9*					24
26	169*	161*	152*	129*	107*	94.6*	82.7*	72.5*				26
28	161*	153*	143*	127*	107*	91.4*	80.5*	71.1*	61.7*	52.7*		28
30		144*	134*	125*	106*	89.2*	78.3*	69.2*	60.7*	52.5*	44.3*	30
32		133*	126*	118*	105*	88.5*	75.5*	67.3*	59.4*	52.2*	44*	32
34		124*	118*	111*	103*	87.9*	73.7*	65.4*	57.8*	51.4*	43.8*	34
36			109*	105*	98.2*	87.2*	73.2*	63.2*	56.1*	50.3*	43.5*	36
38			102*	98.1*	93.3*	86.3*	72.7*	60.9*	54.5*	49.2*	43.2*	38
40				92.1*	88.4*	82.9*	72.1*	60.4*	52.9*	47.8*	42.3*	40
44				81.1*	78.7*	75*	70.4*	59.5*	49.7*	45*	40.3*	44
48					70*	67.8*	64.4*	58.3*	48.9*	42.3*	38*	48
52						60.8*	58.5*	52.9*	44.8*	39.4*	35.8*	52
56							53.2*	48.4*	40.7*	36.5*	33.3*	56
60							48.1*	44.1*	36.7*	33.7*	31.1*	60
64								40.1*	33.1*	30.8*	28.8*	64
68									29.9*	28.1*	26.7*	68
72									27*	25.6*	24.5*	72
76										23.4*	22.6*	76
80											20.6*	80

Unit: t

## Load Chart of LJDB

Load Chart- LJDB (Superlift counterweight: 250t,Rear counterweight: 140t)												
Boom length: 54m, Boom angle: 85°, Jib length: 24m~84m, Superlift radius:15m, Carbody counterweight: 50t												
Jib length Radius(m)	24	30	36	42	48	54	60	66	72	78	84	Jib length Radius(m)
16	204*	182*										16
18	201*	173*	150*									18
20	195*	168*	144*	126*								20
22	184*	164*	139*	121*	106*							22
24	174*	159*	138*	117*	102*	90.1*	78.7*					24
26	162*	151*	135*	116*	98.5*	87.1*	76.8*	67.6*				26
28	150*	141*	131*	115*	97.7*	84.2*	74.7*	66.3*	57.8*			28
30		130*	123*	113*	96.8*	82.2*	72.2*	64.6*	56.7*	49.1*	41.5*	30
32		122*	115*	108*	95.6*	81.6*	69.7*	62.5*	55.2*	48.9*	41.3*	32
34		112*	108*	102*	94.4*	80.8*	68.5*	60.7*	54.1*	48.2*	41.1*	34
36			100*	95.7*	90.2*	80.1*	68*	58.6*	52.3*	47.2*	40.9*	36
38			93.6*	90.1*	85.6*	79.2*	67.4*	57*	50.7*	45.9*	40.7*	38
40				84.5*	80.9*	76*	66.9*	56.6*	49.2*	44.6*	39.8*	40
44				74.6*	72*	69*	64.9*	55.7*	47.1*	41.8*	37.6*	44
48					64.4*	62.2*	59.1*	54.7*	46.3*	39*	35.4*	48
52						55.6*	54*	51.2*	45.1*	38.3*	33*	52
56						50.2*	48.9*	46.9*	40.8*	34.1*	30.7*	56
60							44.1*	42.6*	36.9*	30.5*	28.6*	60
64								39*	33.2*	28*	26.2*	64
68									30.2*	25.5*	24.1*	68
72									27.4*	23.1*	22.2*	72
76										21*	20.2*	76
80											18.5*	80

**Load Chart of LJDB****Load Chart- LJDB (Superlift counterweight: 250t, Rear counterweight: 140t)****Boom length: 60m, Boom angle: 85°, Jib length: 24m~84m, Superlift radius:15m, Carbody counterweight: 50t**

Jib length Radius(m)	24	30	36	42	48	54	60	66	72	78	84	Jib length Radius(m)
16	187*											16
18	175*	155*	135*									18
20	170*	148*	130*	114*								20
22	164*	144*	125*	110*	97.1*							22
24	158*	140*	122*	105*	93.2*	82.9*						24
26	146*	136*	120*	104*	89.8*	80.2*	70.9*	62.8*				26
28	135*	127*	117*	103*	88.6*	77.4*	69*	61.3*	53.6*			28
30		119*	111*	101*	87.5*	75.2*	66.7*	59.7*	52.6*	45.8*		30
32		110*	104*	97.7*	86.3*	74.6*	64.3*	57.7*	51.6*	45.6*	38.5*	32
34		102*	97.5*	92.2*	85*	73.7*	63.2*	56.1*	49.9*	44.7*	38.3*	34
36			91.2*	86.8*	81.7*	72.8*	62.6*	53.8*	48.5*	43.8*	38.2*	36
38			85.2*	82.1*	77.8*	71.9*	62*	53.2*	46.8*	42.4*	37.8*	38
40			79.6*	77*	73.5*	69.5*	61.4*	52.7*	45.1*	41.2*	36.8*	40
44				67.9*	65.6*	62.8*	59.1*	51.8*	44.1*	38.5*	34.7*	44
48					58.1*	56.4*	54*	50.8*	43.3*	36.6*	32.7*	48
52						50.6*	48.7*	46.6*	42.5*	36*	30.2*	52
56						45.6*	44.3*	42.5*	40.4*	34.4*	28.1*	56
60							40*	38.5*	36.9*	31*	25.8*	60
64								35.3*	33.6*	27.6*	23.7*	64
68									30.4*	24.4*	21.7*	68
72									27.6*	21.8*	19.7*	72
76										19.3*	17.8*	76
80											16.2*	80
84											14.7*	84

Unit: t

## Load Chart of LJDB

Load Chart- LJDB (Superlift counterweight: 250t, Rear counterweight: 140t)												
Boom length: 66m, Boom angle: 85°, Jib length: 24m~84m, Superlift radius:15m, Carbody counterweight: 50t												
Jib length Radius(m)	24	30	36	42	48	54	60	66	72	78	84	Jib length Radius(m)
16	166*											16
18	156*	139*										18
20	146*	131*	117*	103*								20
22	140*	124*	111*	99.6*	88.7*							22
24	135*	120*	106*	95.6*	85.6*	76.1*						24
26	130*	116*	103*	90.9*	81.9*	73.5*	65.3*					26
28	123*	113*	101*	89*	78.6*	70.9*	63.6*	56.8*	49.5*			28
30	115*	107*	98*	87.2*	76.5*	68.2*	61.4*	55.1*	49.2*	42.3*		30
32		100*	94*	85.3*	75.2*	65.6*	59.2*	53.5*	47.9*	42.1*	35.7*	32
34		93.6*	88.7*	83.4*	74*	64.8*	56.9*	51.7*	46.3*	41.8*	35.5*	34
36			83.1*	78.8*	72.7*	63.9*	55.8*	49.8*	45*	40.7*	35.4*	36
38			77.8*	74.6*	70.2*	63*	55.2*	47.9*	43.4*	39.3*	35*	38
40			73.4*	70*	66.7*	62*	54.5*	47.2*	41.8*	38.2*	34.1*	40
44				62*	59.6*	57.1*	53.2*	46.2*	39.7*	35.5*	32.2*	44
48					53.3*	51.5*	48.8*	45.2*	38.9*	33.2*	30.1*	48
52						46.2*	44.6*	42.3*	38.2*	32.6*	28*	52
56						41.7*	40.2*	38.5*	36.5*	31.9*	26.9*	56
60							36.3*	35.1*	33.6*	30.8*	24.9*	60
64								32.1*	30.7*	27.6*	21.9*	64
68								29.3*	28.2*	24.6*	19.7*	68
72									25.8*	22*	17.9*	72
76										19.6*	16.1*	76
80											14.6*	80
84											13.2*	84

**Load Chart of LJDB****Load Chart- LJDB (Superlift counterweight: 250t, Rear counterweight: 140t)****Boom length: 72m, Boom angle: 85°, Jib length: 24m~84m, Superlift radius:15m, Carbody counterweight: 50t**

Jib length Radius(m)	24	30	36	42	48	54	60	66	72	78	84	Jib length Radius(m)
16	147*											16
18	139*	124*										18
20	131*	118*	106*									20
22	123*	112*	101*	90.6*								22
24	118*	106*	95.3*	86.8*	78*	69.6*						24
26	114*	103*	91.7*	82.4*	75*	67.2*	60.1*					26
28	110*	99.2*	89.2*	79.4*	71.4*	65.1*	58.4*	52.2*				28
30	104*	95.9*	86.7*	77.7*	68.7*	62.2*	56.3*	50.8*	45.1*	38.7*		30
32		91.7*	84.2*	75.8*	67.4*	59.6*	54.2*	49.1*	44*	38.6*	32.6*	32
34		85.7*	81.1*	74*	66.1*	58.8*	52.1*	47.3*	42.8*	38.5*	32.5*	34
36		80.3*	75.9*	72.1*	64.7*	57.8*	50.7*	45.8*	41.3*	37.5*	32.4*	36
38			71.6*	68*	63.6*	56.9*	50*	43.7*	40*	36.2*	32.2*	38
40			67*	64.2*	61.1*	55.8*	49.4*	43.1*	38.3*	35.2*	31.5*	40
44				57.2*	54.8*	52.3*	47.9*	42.1*	36.4*	32.6*	29.6*	44
48					49*	47.1*	44.7*	40.9*	35.6*	30.6*	27.6*	48
52					44*	42.5*	40.7*	38.7*	34.8*	29.9*	25.5*	52
56						38.3*	36.8*	35.4*	33.5*	29.2*	25*	56
60							33.2*	32.1*	30.6*	28.6*	24.4*	60
64								29.3*	28.1*	26.8*	22*	64
68								26.7*	25.7*	24.4*	19.3*	68
72									23.5*	22*	16.7*	72
76										19.7*	14.5*	76
80											13*	80
84											11.6*	84

Unit: t

## Load Chart of LJDB

Load Chart- LJDB (Superlift counterweight: 250t, Rear counterweight: 140t)												
Boom length: 78m, Boom angle: 85°, Jib length: 24m~84m, Superlift radius:15m, Carbody counterweight: 50t												
Jib length Radius(m)	24	30	36	42	48	54	60	66	72	78	84	Jib length Radius(m)
18	125*	112*										18
20	118*	106*	95.1*									20
22	111*	101*	91.4*	82.4*								22
24	103*	94.9*	86.9*	78.9*	70.8*							24
26	97.3*	88.6*	81.8*	75.3*	68.4*	61.5*	55.2*					26
28	93.7*	84.9*	77.3*	71.2*	65.5*	59.5*	53.7*	47.9*				28
30	90.6*	82.1*	74.3*	67.5*	62.2*	57.1*	51.7*	46.6*	40.9*			30
32		79.3*	72*	65.5*	59.2*	54.7*	49.8*	45.2*	40.5*	35*	29.6*	32
34		76.8*	69.9*	63.8*	57.4*	51.9*	47.8*	43.6*	39.4*	34.8*	29.5*	34
36		73.8*	67.8*	62.1*	56.1*	50.1*	45.7*	41.9*	38*	34.4*	29.3*	36
38			65.5*	60.4*	54.8*	49.2*	43.7*	40.2*	36.6*	33.4*	29.2*	38
40			61.4*	58.5*	53.5*	48.2*	42.9*	38.5*	35.4*	32.3*	29*	40
44				52.2*	49.9*	46.2*	41.4*	36.7*	32.5*	30*	27.2*	44
48					44.9*	43*	39.9*	35.4*	31*	27.6*	25.1*	48
52					40.5*	38.8*	37*	34.3*	30.4*	26.4*	23.3*	52
56						35*	33.5*	32.1*	29.4*	25.7*	22*	56
60							30.5*	29.2*	27.7*	25*	21.5*	60
64								26.6*	25.4*	24.1*	20.9*	64
68								24.3*	23.2*	22.2*	19.5*	68
72									21.3*	20.3*	16.9*	72
76										18.6*	14.7*	76
80										17.1*	12.6*	80
84											10.6*	84

**Load Chart of LJDB****Load Chart- LJDB (Superlift counterweight: 250t, Rear counterweight: 140t)****Boom length: 84m, Boom angle: 85°, Jib length: 24m~84m, Superlift radius:15m, Carbody counterweight: 50t**

Jib length Radius(m)	24	30	36	42	48	54	60	66	72	78	84	Jib length Radius(m)
18	111*											18
20	106*	95.8*	85.7*									20
22	99.7*	90.8*	82.3*	74.1*								22
24	92.8*	85.7*	78.7*	71.4*	64.5*							24
26	86.8*	80.6*	74.6*	68.5*	62.3*	56.1*						26
28	82.7*	75.5*	70*	65.1*	59.5*	54.2*	49*	42.9*				28
30	79.8*	72.9*	66.3*	61.3*	56.8*	52*	47.2*	42.6*	36.6*			30
32		70.4*	64.2*	58.3*	54*	49.7*	45.4*	41.2*	36.4*	31.3*		32
34		68.1*	62.2*	56.7*	51.2*	47.4*	43.7*	39.8*	35.9*	31.1*	26.4*	34
36		66.1*	60.3*	55.1*	50*	45.1*	41.8*	38.5*	34.8*	30.9*	26.2*	36
38			58.5*	53.6*	48.6*	43.9*	39.9*	36.6*	33.5*	30.5*	26*	38
40			56.7*	52*	47.4*	42.9*	38.4*	35.3*	32.2*	29.6*	25.8*	40
44				48.4*	45*	40.9*	36.8*	32.8*	29.6*	27.3*	24.7*	44
48				43.6*	41.5*	39*	35.2*	31.7*	28*	25.1*	22.9*	48
52					37.3*	35.7*	33.7*	30.5*	27.1*	23.6*	21.1*	52
56						32.4*	30.8*	29.3*	26.1*	22.9*	19.7*	56
60							28*	26.8*	25.2*	22.1*	19.1*	60
64							25.6*	24.4*	23.2*	21.4*	18.5*	64
68								22.3*	21.3*	20.1*	17.8*	68
72									19.5*	18.5*	17*	72
76										16.9*	14.9*	76
80										15.5*	12.9*	80
84											11*	84







## Zhejiang Sany Equipment Co.,LTD

SANY Crawler Crane Industrial Park, No. 2188 Daishan Road, Wuxing District, Huzhou City, Zhejiang Province, P. R. China Zip 313028  
Consulting [sanycrane@sanygroup.com](mailto:sanycrane@sanygroup.com) (Crane BU) / [crd@sany.com.cn](mailto:crd@sany.com.cn) (IHQ)  
After-sales Service 0086-400 6098 318

Reminder:

Any change in the technical parameters and configuration due to product modification or upgrade may occur without prior notice. The machine in the picture may include additional equipment. This brochure is for reference only, and goods in kind shall prevail. Copyright at SANY. No part of this brochure may be copied or used for any purpose without written approval from SANY.

© Edited in August 2022

