



SCE600A

Crawler Crane

60 Tons Lifting Capacity

Quality Changes the World



Max. lifting moment: 222t·m
Max. boom length: 52m
Max. fixed jib combination: 43m+15.25m

The parameters and diagrams in the brochure are only for reference, which are subject to further update in real machine.

■ www.sanyglobal.com



Crawler Crane Series SCE600A

P03

Main
Characteristics

- Product Specification
- Safety Device

P09

Technical
Parameters

- Major Performance & Specifications
- Outline Dimension
- Transport Dimension
- Transport Plan

P17

Cofigurations

- H Configuration
- FJ Configuration



SCE600A
SANY CRAWLER CRANE
60 TONS LIFTING CAPACITY

QUALITY CHANGES THE WORLD

Main Characteristics

- Page 04 Product Specification
- Page 07 Safety Device



Product Specification



Engine

- Model: Cummins B6.7-C195 Diesel engine;
- Type: 4-stroke, water-cooled, vertical in-line 6 cylinders, direct injection, turbo-charger, intercooler, complied with European Off-highway Stage V Emission Standard;
- Displacement: 6.7L;
- Rated power: 145kW/2000rpm;
- Operation power: 142kW/1800rpm;
- Max. Torque: 847N·m/1500rpm;
- Starter: 24V-7.8kW;
- Cooling system: pressurized water circulating system with temperature adjustable;
- Radiator: fin type aluminum plate core;
- Air cleaner: Dry type system with main filter element, safety element and resistance indicator;
- Throttle: Grip type hand throttle, electrically-controlled;
- Fuel filter: Replaceable paper element;
- Batteries: Two 12V×165Ah capacity batteries, connected in series;
- Fuel tank capacity: 400L.

Electrical Control System

- Self-developed SYIC-II integrated control system is adopted with higher integration, precise operation and reliable quality;
- Control system consists of power system, engine system, main control system, LMI system, auxiliary system and safety monitoring system. CAN BUS is used for data communication between controller, monitor and the engine;
- Monitor: the working parameters and status are shown on the monitor, such as the engine speed, fuel volume, engine oil pressure, servo pressure, engine working hours, lifting conditions and boom angle.

Hydraulic System

- Main pumps: three open variable displacement piston pumps are adopted to provide oil supply for main actuators of main machine;
- Gear pump: one gear pump is used to control the oil return circuit;
- Control: main pump adopts electrically-controlled positive flow control; winch motor adopts limitless adjustable piston motor of variable displacement. The operating components are two cross hydraulic handles and one dual hydraulic handle for travel, to control various actuators proportionally;
- Way of cooling: heat exchanger, plate-fin type core and multi-stage cooling;
- Filter: large flow, high precision filter, with bypass valve and transmitter, which can remind the user to replace the filter element in time;
- Max. pressure of system: 32MPa;
- Main/aux. load hoist and travel system: 32MPa;
- Swing system: 30MPa;
- Control system: 5MPa;
- Hydraulic Tank Capacity: 260L.

Main and Aux. Load Hoist Mechanism

- Main and aux. hoist winches are driven separately by motor via gearbox. Operating winch handle can control the winch to rotate to two directions, which are lifting and lowering of hook. Excellent inching function is equipped on the machine;
- Drums with fold-line grooves can ensure the wire rope reeved in order in multilayers;
- Free fall for main/aux. load hoist is offered as optional.

Main Load Hoist Mechanism	Drum diameter	520mm
	1st layer rope speed	0~120m/min
	Wire rope diameter	22mm
	Wire rope length of main load hoist	180m
	Rated single line pull	7t
Auxiliary Load Hoist Mechanism	Drum diameter	520mm
	1st layer rope speed	0~120m/min
	Wire rope diameter	22mm
	Wire rope length of auxiliary load hoist	130m
	Rated single line pull	7t



Product Specification

Boom Hoist Mechanism

- Boom hoist winches are driven separately by motor via gearbox. Operating winch handle can control the winch to rotate to two directions, which are lifting and lowering of boom;
- Drums with fold-line grooves can ensure the wire rope reeved in order in multilayers.

Boom hoist mechanism	Drum diameter	290mm
	Single rope speed	0~95m/min
	Wire rope diameter	16mm
	Wire rope length of boom hoist	142m
	Rated single line pull	3.7t

Swing Mechanism

- Swing brake adopts wet, spring loaded, normally-closed brake, and braking through spring force;
- Swing system has three work modes to accommodate different needs. It is featured in small backlash, steady control, and excellent inching function. It also has free slipping function and swing control on slope to avoid sudden braking;
- Swing drive: internal engaged swing drive with 360° swing range, and the max. swing speed is 3.5r/min. The max. drive pressure can reach 32MPa;
- Swing lock: cylinder lock can ensure the upperworks locked securely on four directions after work or during transport;
- Swing ring: single row ball bearing.

Cab and Control

- Novel operator's cab with fashionable profile and nice interior. There are low and high-beam lights, back-view mirror, heater and A/C, radio and other functions. The layout of seat, handles, control buttons are designed with ergonomic principles to make operation more comfortable;
- Cab layout: Integrated 10.4-inch touch screen, programmable smart switches, vibration handles are offered as optional and man-machine interaction interface are more perfect;
- Armrest box: on the left and right armrest box are control handles, electrical switches, emergent stop and ignition switch. The armrest box can be adjusted along with the seat;
- Seat: multi-way and multi-level floating adjustable seat with unload switch;
- A/C: cool and heat air; optimized air channels and vents;
- Multiple cameras can present on the monitor at the same time to realize real-time monitoring of machine backing, wire rope on each winch, conditions behind the counterweight and surrounding the machine.

Counterweight

- Counterweight tray and blocks are piled up for easier assembly and transport;
- Total rear counterweight: total 16.4t;
- Rear counterweight: counterweight tray 5.3t×1, middle counterweight 7.3t×1, left counterweight block 2.4t×1, right counterweight block 1.4t×1.

Upperworks

- High-strength steel weld framework, with no torsion or deformation. The parts are laid out in the way that is easier for maintenance and service.

Product Specification



Lowerworks

- Independent travel driving units are adopted for each side of the crawler, to realize straight walking and turning driven by travel motor through gearbox and drive wheel.

Crawler Extension and Retraction

- The crawlers can extend and retract via cylinders. During Work Mode, the crawlers must be extended, and be retracted during transport with crawlers on.

Crawler Tensioning

- The jack is used to push the guide wheel and insert the shim to adjust crawler tension.

Track Pad

- High-strength alloy cast steel track pad can prolong the service life. They are 770mm wide, and the total amount is 59pcs x 2.

Operating Equipment

- All chords are high-strength steel tubes, and the boom/jib top sheaves are made of high-strength anti-wearing Nylon material protecting wire rope. The hooks are installed with milled welded steel sheave. Pendant cables with quick hitch connector that are easy to assemble are offered as options.

Boom

- Lattice structure. The chord adopts high-strength structural tube and each section is connected through pins;
- Basic boom: 6.5m boom top + 6.5m boom base;
- Boom insert: 3m x 1, 6m x 3, 9m x 2;
- Boom length: 13m~52m.

Fixed Jib

- Lattice structure. The chord adopts high-strength structural tube and each section is connected through pins;
- Basic boom: 3.05m boom top + 3.05m boom base;
- Boom insert: 3.05m x 3;
- Jib length: 6.1m~15.25m;
- Longest boom + jib: 43m boom + 15.25m jib.

Extension Jib

- The extension jib is a welded structure connected to the boom top by pins, used for auxiliary hook;
- Extension jib length: 1.0m.

Hook Block

- 60t hook block, five sheaves;
- 45t hook block, three sheaves;
- 15t hook block, one sheave;
- 9t ball hook.



Safety Device

Assembly Mode/Work Mode Switch

- In Assembly Mode, certain safety devices are disabled to facilitate crane assembly;
- In Work Mode, all safety devices activate to protect the operation.

Emergent Stop

- In emergent situation, this button is pressed down to cut off the power supply of the whole machine and all actions stop.

Load Moment Indicator (LMI)

- It is an independent computerized safety control system. LMI can automatically detect the load weight, work radius and boom angle, and present on the display the rated load, actual load, work radius and boom angle. In normal operation, the LMI can make a judgment and cut off automatically if the crane moves towards dangerous direction. It can also perform as a black box to record the lifting information;
- It is composed of monitor, angle sensor, force sensor and other parts.

Over-hoist Protection of the Main/ Auxiliary Load Hoist

- Over-hoist protection device comprises limit switch and weight on boom top, which prevents the hook lifting up too much. When the hook lifts up to the limit height, the limit switch activates, buzzer on the left control panel sends alarm, failure indicator light starts to flash and the hook hoisting action is cut off automatically.

Over-release Protection Device of the Main/Auxiliary Load Hoist

- It is comprised of activator in the drum and proximity switch to prevent over release of wire rope. When the rope is paid out close to the last three wraps, the proximity switch acts, and the system sends alarm through buzzer and show the alarm on the monitor, automatically cutting off the winch action.

Function Lock

- If the function lock lever is not in work position, all the other handles won't work, which prevents any mis-operation caused by accidental collision.

Boom Hoist Drum Lock

- Hydraulically controlled lock is installed for boom hoist drum, which needs to unlock by switch before operation, in order to prevent mis-operation of handles and ensure safety during non-work time.

Swing Lock

- Swing Lock can lock the machine.

Boom Limit Device

- When the boom elevation angle reaches the upper limit, the buzzer sounds and boom action is cut off. This protection is two-stage control ensured by both LMI system and travel switch.

Back-stop Device

- Its major components are nesting tubes and spring, in order to buffer the boom backlash and prevent further tipping back.

Boom Angle Indicator

- Pendulum angle indicator is fixed on the side of boom base close to the cab, so as to provide convenience to the operator.

Hook Latch

- The lifting hook is installed with a baffle plate to prevent wire rope from falling off.

Safety Device



Tri-color Load Indicator

- The load indication light has three colors, green, yellow and red, and the real time load status is presented on the display. When the actual load is smaller than 90% of rated load, the green light is on; when the actual load is larger than 90% and smaller than 100%, the yellow light is on, the alarm light flashes and sends out intermittent sirens; when the actual load reaches 100% of rated load, the red light is on, the alarm light flashes and sends out continuous sirens. At this moment, the system will automatically cut off the crane's dangerous operation.

Alarm Light

- When the machine is powered on, the alarm light will work when time comes, so as to warn people around.

Swing Indicator Light

- The swing indicator light flashes during traveling or swing.

Illuminating Light

- The machine is equipped with short-beam light in front of machine, front angle adjustable far-beam light, lamps in operator's cab, lighting devices for night operation, so as to increase the visibility during work.

Rearview Mirror

- It is installed on the left of the operator's cab and at the front handrail of the sheet metal for monitoring the rear part of the machine.

Pharos

- Pharos is mounted on the top of boom/jib to indicate the height.

Anemometer

- It is mounted on the top of boom/jib, and displayed on the monitor in the cab.

Electronic Level Gauge

- It displays the tipping angle of crane on the monitor in real time and sends out alarm to the operator automatically when the angle is out of limit.

Seat Interlock

- If the operator leaves the seat, all control handles will be locked immediately to prevent any mis-operation due to accidental collision.

Engine Power Limit Load Adjustment and Stalling Protection

- The controller monitors the engine power to prevent engine getting stuck and stalling.

Engine Status Monitoring

- The engine status will be presented, such as engine coolant temperature, fuel volume, total work hours, engine oil pressure, engine speed, battery charging and voltage.

Monitoring System

- Remote Monitoring system is a standardized offering to provide functions like GPS locating, GPRS data transfer, machine status inquiry and statistics, operating data monitoring and analysis, remote diagnosis of failures.



SCE600A
SANY CRAWLER CRANE
60 TONS LIFTING CAPACITY

QUALITY CHANGES THE WORLD

Technical Parameters

- Page 10 Major Performance & Specifications
- Page 11 Outline Dimension
- Page 12 Transport Dimension
- Page 16 Transport Plan



Major Performance & Specifications

Major Performance & Specifications of SCE600A			
Performance Indicators		Unit	Parameter
Boom Configuration	Max. rated lifting capacity	t	60
	Largest lifting moment	t·m	222
	Boom length	m	13~52
Fixed Jib	Max. rated lifting capacity	t	7
	Jib length	m	6.1~15.25
	Longest boom + jib	m	43+15.25
Speed	Rope speed of main/aux. winch (1st layer)	m/min	120
	Rope speed of boom hoist winch	m/min	95
	Swing speed	rpm	0~3.5
	Travel speed	km/h	0~2.0
Wire rope	Main load hoist wire rope: diameter × length	φ mm × m	22×180
	Aux. load hoist wire rope: diameter × length	φ mm × m	22×130
	Rated single line pull of main/aux. hoist wire rope	t	7
Engine	Model/Displacement	\L	B6.7/6.7
	Rated power/revolution speed	kW/ rpm	145/2000
Transport Parameters	Weight of whole machine (with basic boom, full counterweight, boom extension jib, 60T hook and 9T ball hook)	t	49.9
	Rear counterweight	t	16.4
	Transport weight of basic machine (with crawlers and boom base)	t	31.6
	Machine transport dimension (with crawlers and boom base) L×W×H	mm	12200×3000×3300
Other specifications	Average ground pressure (basic boom)	MPa	0.065
	Gradeability	%	40

Unit: mm

Outline Dimension

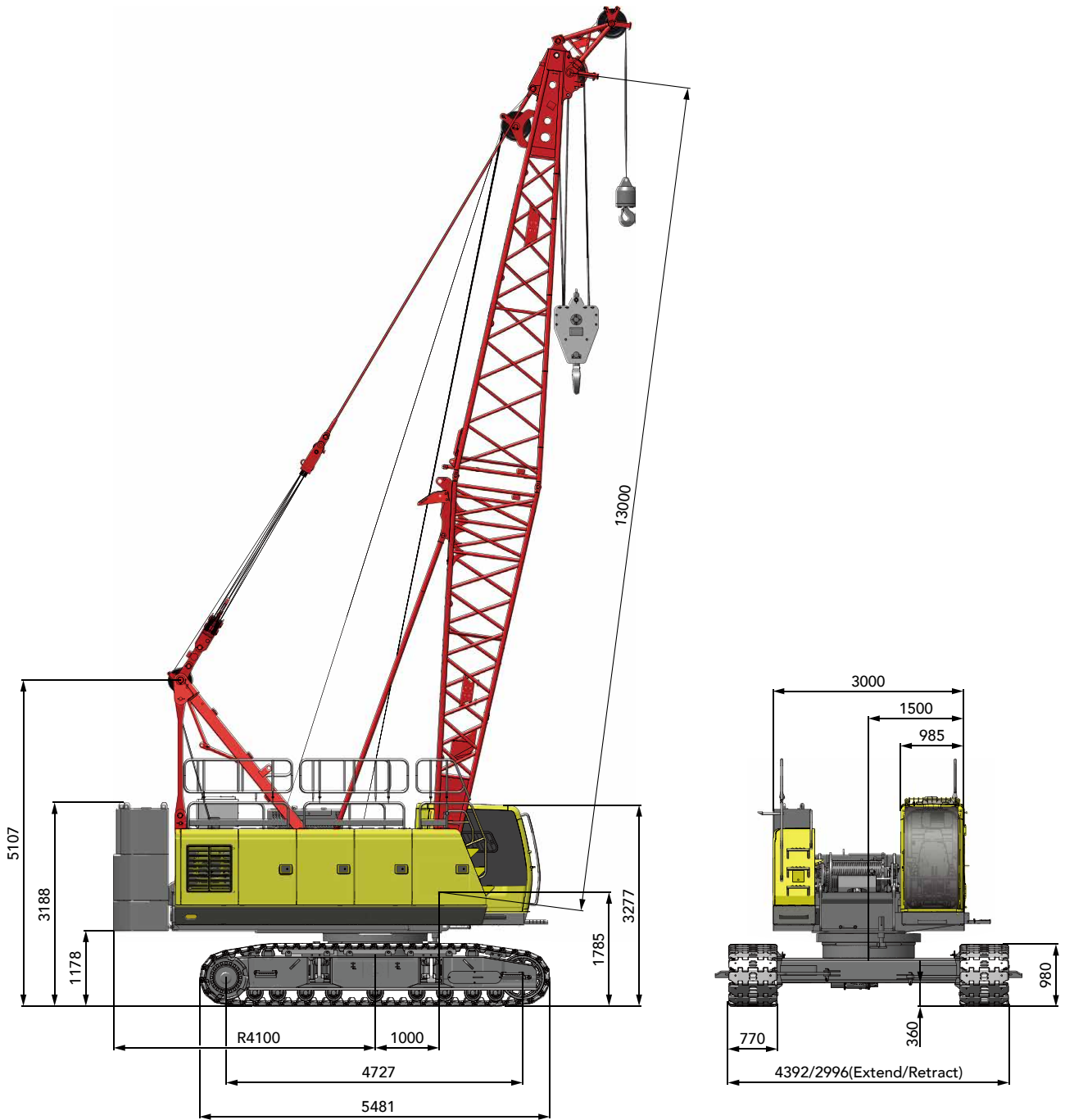

Transport Dimension

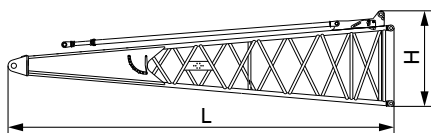
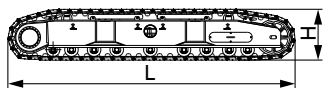
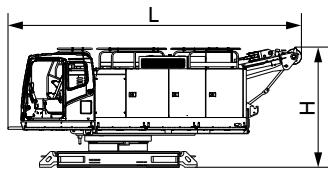
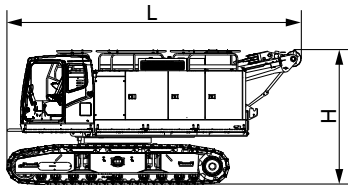
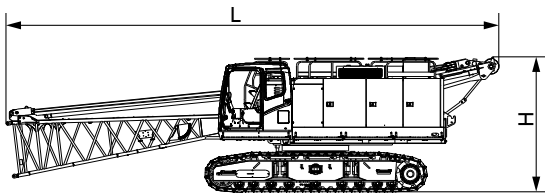
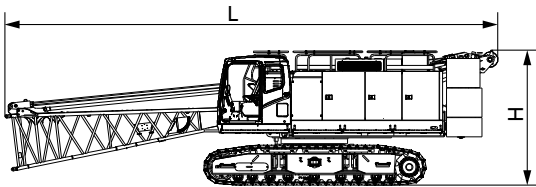

Basic Machine 1 (with boom base , crawler frames and counterweight) ×1

Length(L)	12.20m
Width(W)	3.00m
Height(H)	3.30m
Weight	48.0t

Basic Machine 2 (with boom base and crawler frames) ×1

Length(L)	12.20m
Width(W)	3.00m
Height(H)	3.30m
Weight	31.6t

Basic Machine 3 (with crawler frames) ×1

Length (L)	7.21m
Width (W)	3.00m
Height (H)	3.30m
Weight	30.2t

Basic Machine 4 ×1

Length (L)	7.20m
Width (W)	3.00m
Height (H)	2.94m
Weight	18.0t

Crawler frame ×2

Length (L)	5.50m
Width (W)	0.90m
Height (H)	0.98m
Weight	6.1t

Boom base ×1

Length(L)	6.65m
Width(W)	1.39m
Height(H)	1.65m
Weight	1.35t

Transport Dimension

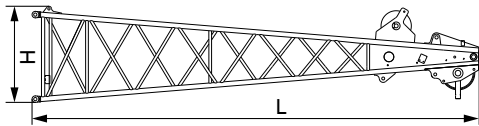

Boom top ×1

Length(L)	6.88m
Width(W)	1.39m
Height(H)	1.48m
Weight	0.9t

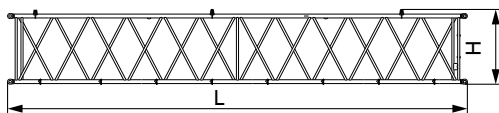

9m boom insert ×2

Length(L)	9.10m
Width(W)	1.39m
Height(H)	1.48m
Weight	0.85t

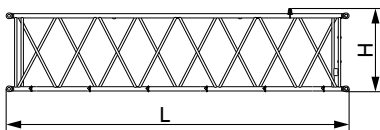

6m boom insert ×3

Length(L)	6.10m
Width(W)	1.39m
Height(H)	1.48m
Weight	0.55t

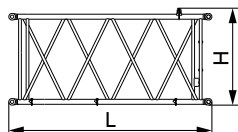

3m boom insert ×1

Length (L)	3.10m
Width (W)	1.39m
Height (H)	1.48m
Weight	0.33t

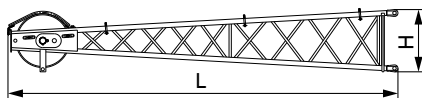

Fixed jib top ×1

Length (L)	3.38m
Width (W)	0.70m
Height (H)	0.55m
Weight	0.15t

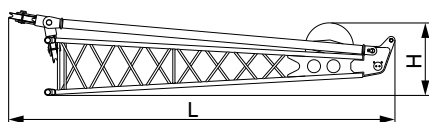

Fixed jib base and strut ×1

Length(L)	3.57m
Width(W)	0.61m
Height(H)	0.78m
Weight	0.25t

Transport Dimension

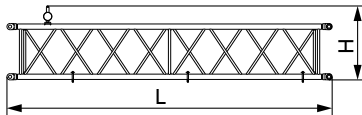

3.05m fixed jib ×3

Length(L)	3.11m
Width(W)	0.62m
Height(H)	0.70m
Weight	0.1t

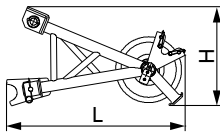

Boom extension jib ×1

Length(L)	1.26m
Width(W)	0.71m
Height(H)	0.70m
Weight	0.12t

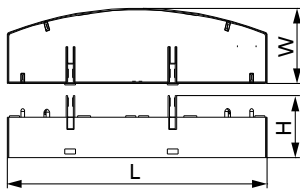

Counterweight Tray ×1

Length(L)	3.00m
Width(W)	0.86m
Height(H)	0.72m
Weight	5.3t

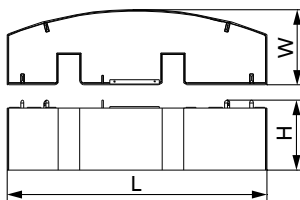

Middle Counterweight Block ×1

Length (L)	3.00m
Width (W)	0.86m
Height (H)	0.81m
Weight	7.29t

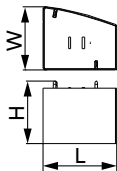

Left Counterweight Block ×1

Length (L)	0.96m
Width (W)	0.82m
Height (H)	0.81m
Weight	2.35t

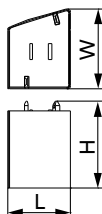

Right Counterweight Block ×1

Length(L)	0.59m
Width(W)	0.75m
Height(H)	0.81m
Weight	1.37t

Transport Dimension

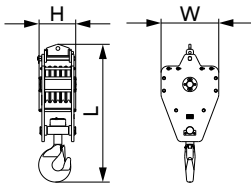

60t hook	×1
Length(L)	1.65m
Width(W)	0.69m
Height(H)	0.39m
Weight	0.65t

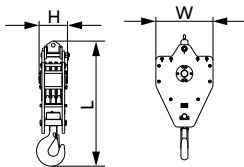

45t hook	×1
Length(L)	1.52m
Width(W)	0.69m
Height(H)	0.37m
Weight	0.48t

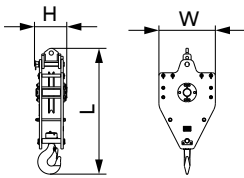

15t hook	×1
Length (L)	1.34m
Width (W)	0.60m
Height (H)	0.34m
Weight	0.28t

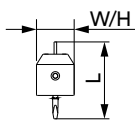

9t ball hook	×1
Length (L)	0.73m
Width (W)	0.33m
Height (H)	0.33m
Weight	0.18t

Note:

- 1.The transport dimensions of each part in the table are schematic, not proportional to the real parts. The dimensions are designed value without package considered.
- 2.The Weight is designed value that the actual manufactured part may deviate a little

Transport Plan

Transport with crawler frames

Trailer 1	
Part(s)	<ul style="list-style-type: none"> Basic machine
Weight	<ul style="list-style-type: none"> 31.6t

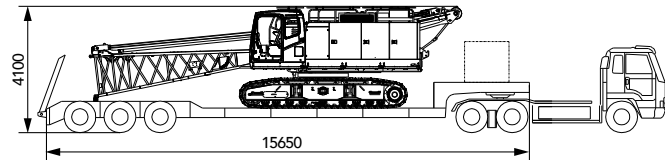

Trailer 2	
Part(s)	<ul style="list-style-type: none"> 6m insert boom x3 Boom top x1 Boom extension jib x1 3.05m fixed jib x1 Middle counterweight block x1 Right counterweight block x1 60t hook x1 9t hook x1
Weight	<ul style="list-style-type: none"> 12.26t

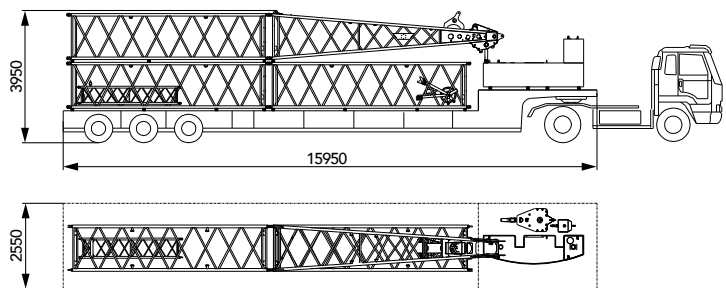

Trailer 3	
Part(s)	<ul style="list-style-type: none"> 9m insert boom x2 3m insert boom x1 Fixed jib base and strut x1 Fixed jib top x1 3.05m fixed jib x2 Counterweight tray x1 Left counterweight block x1 45t hook x1 15t hook x1
Weight	<ul style="list-style-type: none"> 11.04t

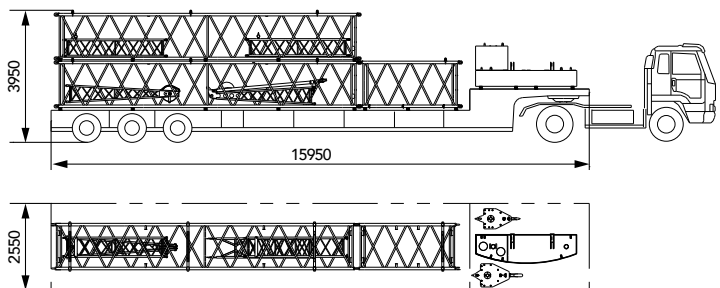



SCE600A
SANY CRAWLER CRANE
60 TONS LIFTING CAPACITY

QUALITY CHANGES THE WORLD

Boom Combination

- Page 19 H Configuration
- Page 22 FJ Configuration

> 17

Boom Combination

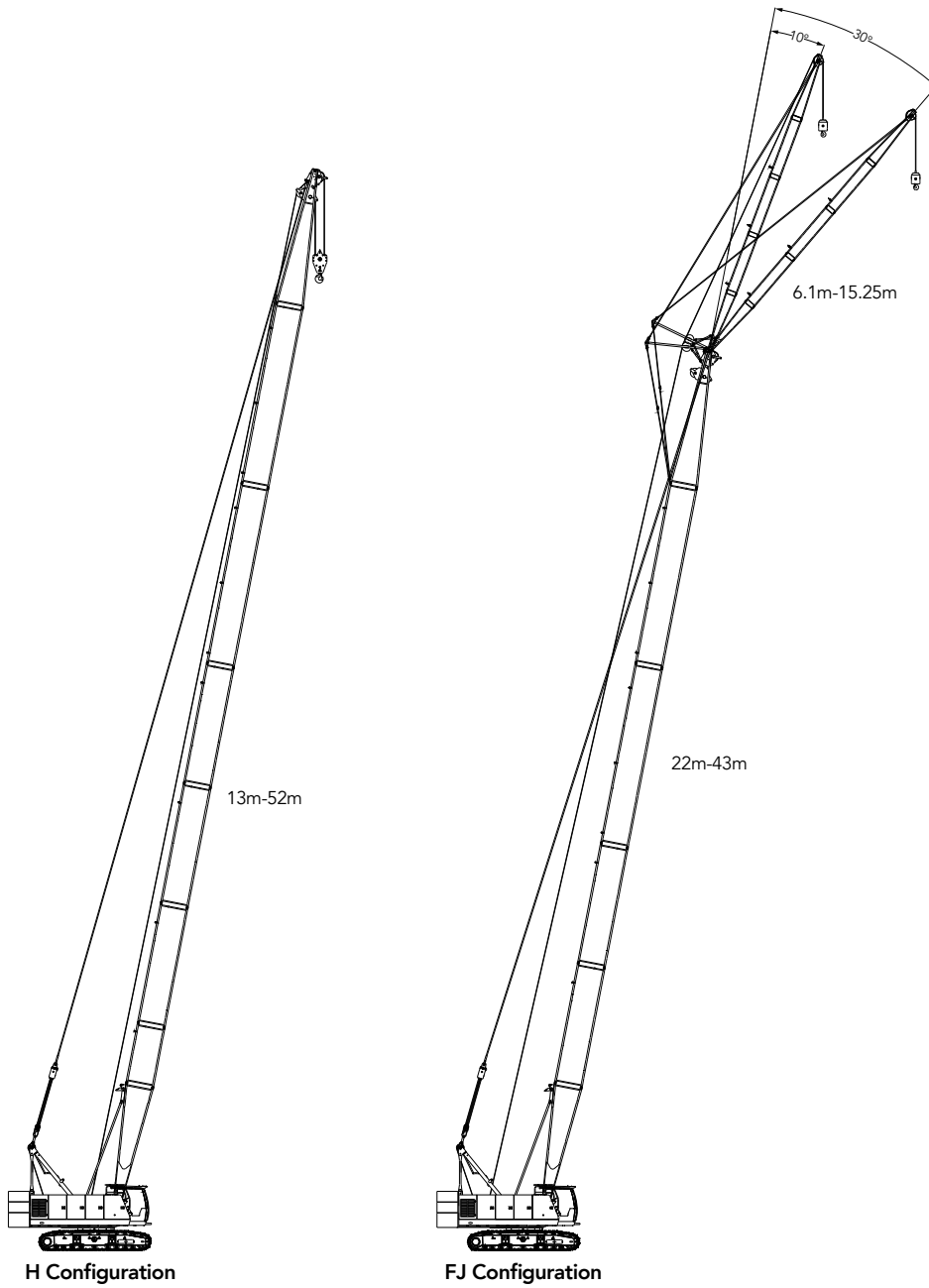

Configuration	Boom Combination	Boom Length
H	Boom	22m~43m
FJ	Boom + Fixed Jib (single hook)	(22m~43m)+(6.1m+15.25m)

The schematics above are reference for loading only.

H Configuration

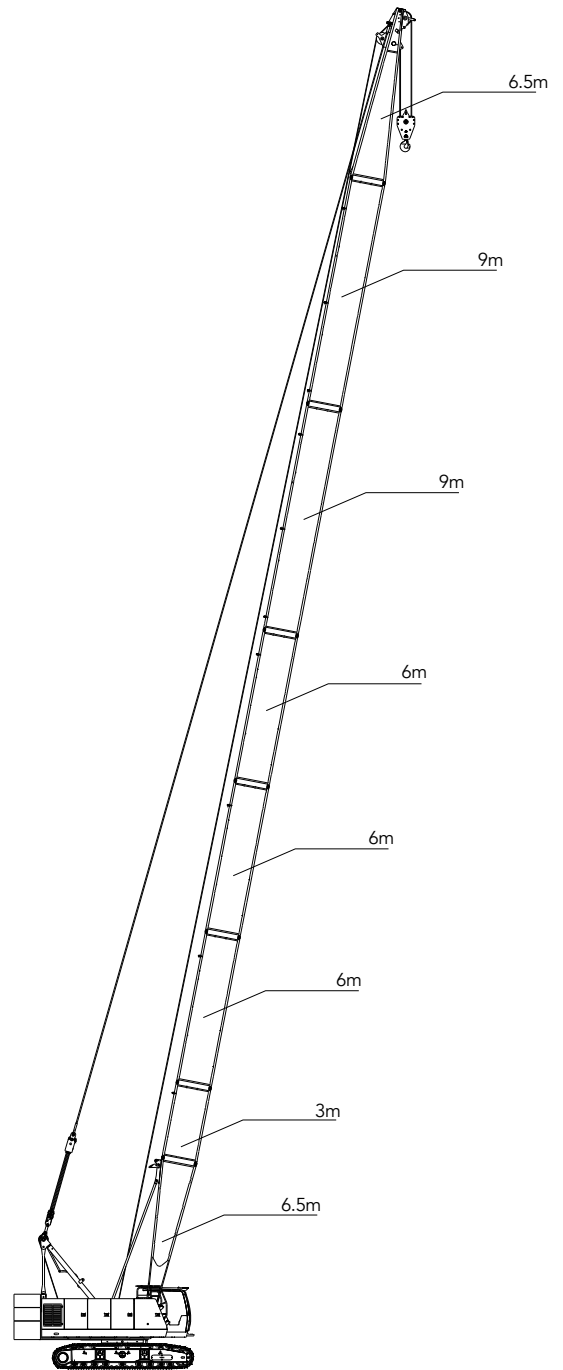
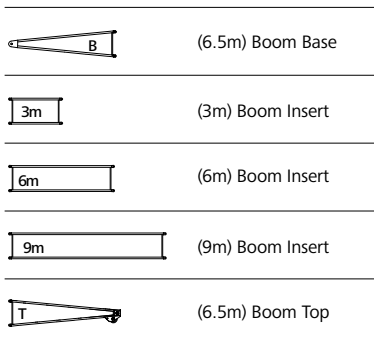
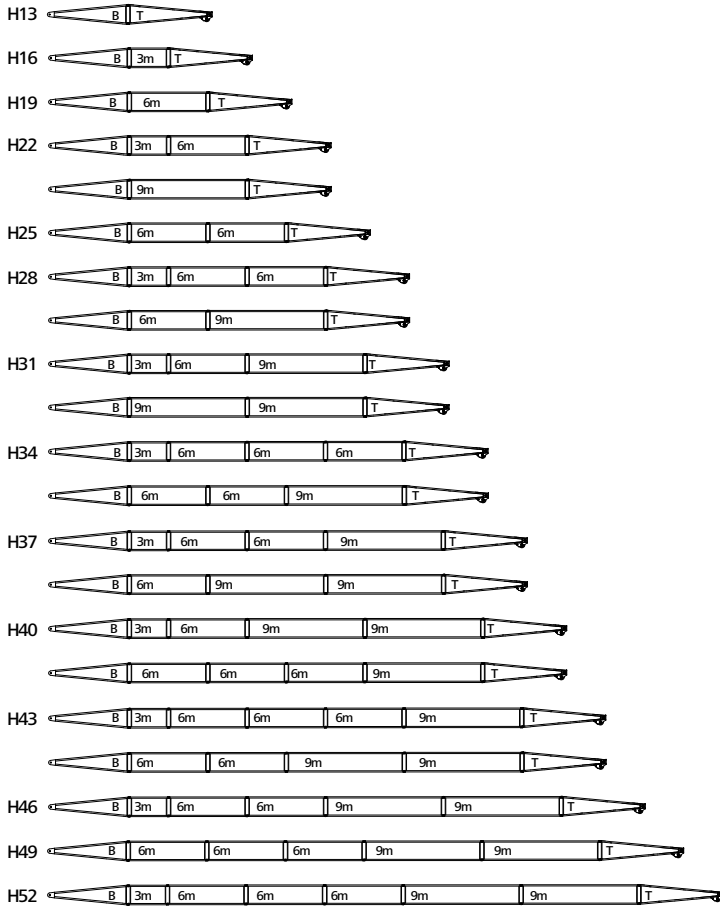

Longest boom: 52m

Working Radius in H Configuration

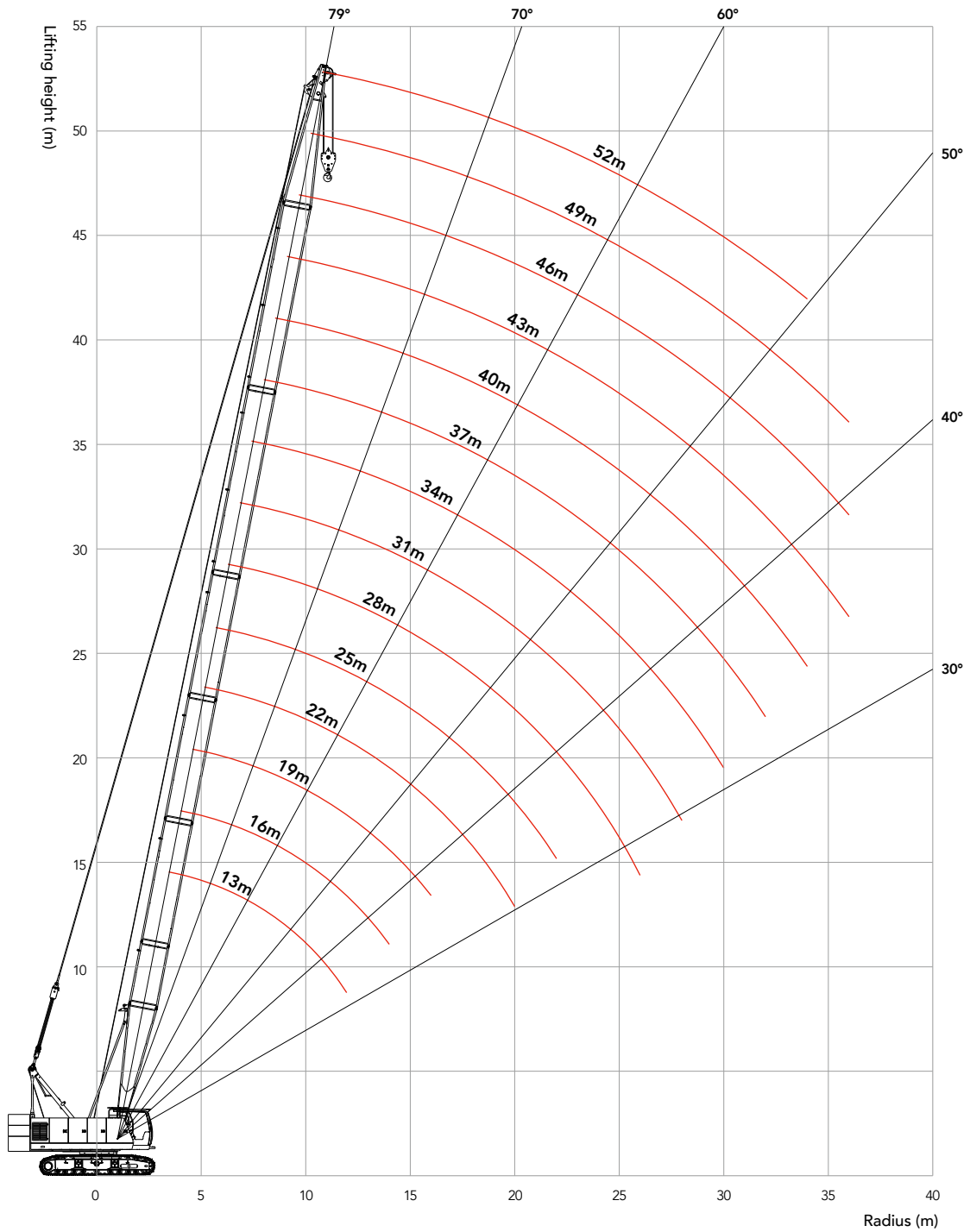

Unit: t

Load Chart of H Configuration

SCE600A Crawler Crane –H Configuration																	
Rear counterweight 16t																	
R(m)	BL(m)	13	16	19	22	25	28	31	34	37	40	43	46	49	52	BL(m)	R(m)
3.7	60																3.7
4	50.2	48.2															4
4.5	42.5	41.8	40.2														4.5
5	37.5	36	35	33.2													5
5.5	32.5	31.9	31	30.2	28.2												5.5
6	28.5	28.3	27.5	27.2	26.2	25.2											6
7	22.9	22.7	22.5	22.2	21.7	21.2	20.5										7
8	19.2	19	18.7	18.5	18.5	18	17.5	17.1	16.7								8
9	16.1	15.7	15.7	15.6	15.5	15.4	14.8	14.2	14	13.2	12.8						9
10	14.2	14	13.9	13.9	13.7	13.7	13.5	13.2	12.8	12.5	12.1	11.7	11.3				10
12	11.3	11.2	11.1	11	10.9	10.8	10.8	10.5	10.3	10	9.6	9.3	9.2	9.2			12
14		9.3	9.2	9.1	9	8.8	8.8	8.6	8.5	8.2	8	7.7	7.4	7.4			14
16			7.8	7.7	7.6	7.5	7.4	7.2	7.1	6.9	6.9	6.6	6.4	6.2			16
18				6.6	6.5	6.5	6.4	6.2	6.1	5.9	5.8	5.5	5.3	5.1			18
20				5.6	5.6	5.5	5.5	5.3	5.2	4.9	4.9	4.7	4.4	4.3			20
22					4.8	4.8	4.6	4.5	4.3	4.2	4.1	3.9	3.7	3.6			22
24						4.2	4	3.9	3.7	3.6	3.5	3.3	3.2	3			24
26						3.6	3.6	3.4	3.3	3.2	3	2.9	2.7	2.5			26
28							3	3	2.9	2.7	2.5	2.4	2.3	2.1			28
30								2.6	2.5	2.3	2.1	2	1.9	1.7			30
32									2.1	2	1.8	1.7	1.6	1.4			32
34										1.7	1.5	1.4	1.3	1.2			34
36											1.1	1	0.9				36

Notes: Rated capacity of crawler crane

- ① The rated capacity in the load charts is calculated when the crane is parking on firm and level ground, lifting the load slowly and steadily.
- ② The shaded values are determined by strength.
- ③ The rated capacity values in the load charts are only valid when wind speed is lower than 9.8m/s.
- ④ The rated capacity in the load charts includes the weight of hook, wire rope and other riggings; therefore, the actual rated capacity shall deduct the weight of these components.
- ⑤ The crawlers must be extended during lifting.
- ⑥ The values in the load charts are valid for 360° swing.

FJ Configuration

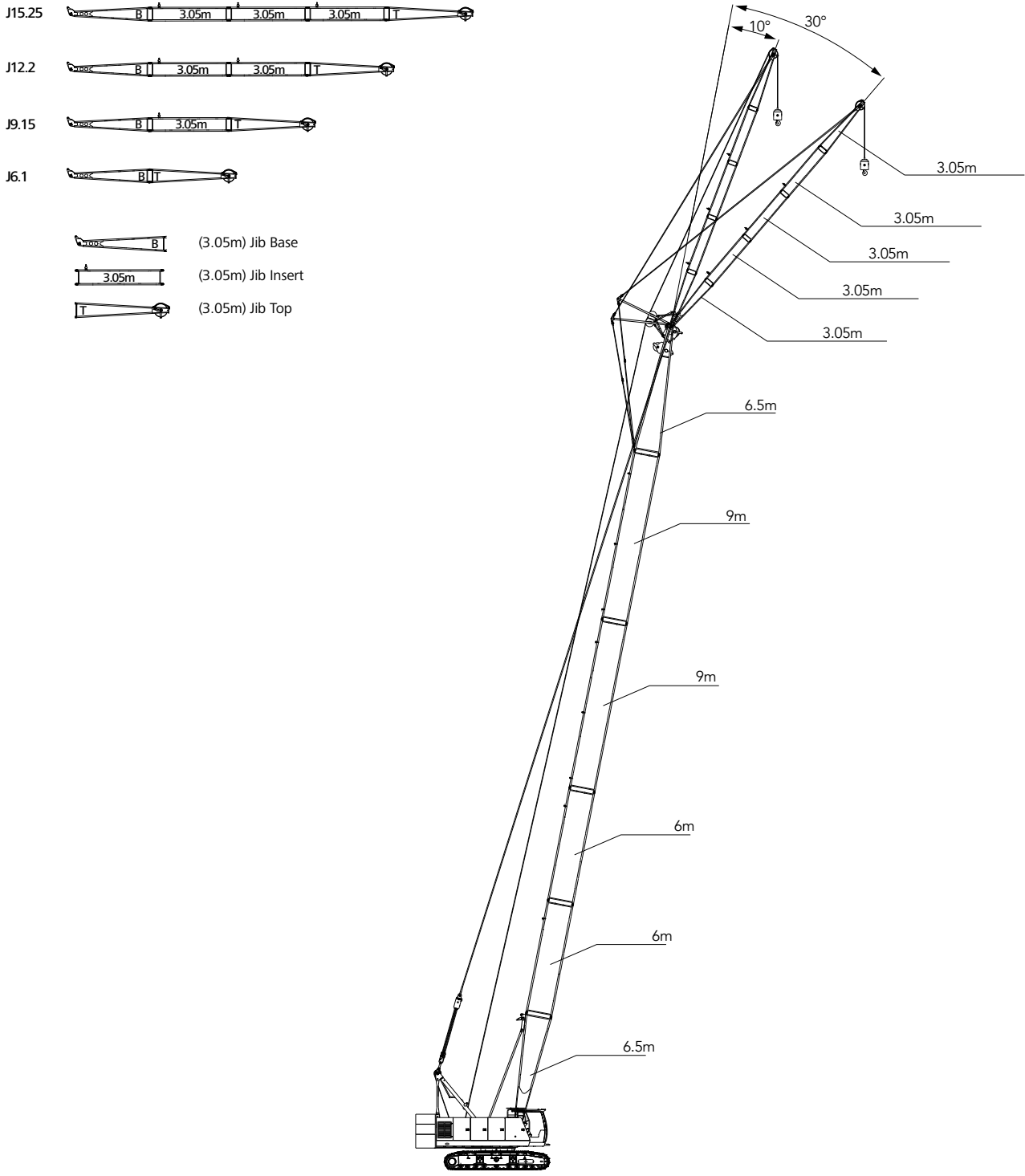

Longest boom + jib: 43m+15.25m

Working Radius in FJ Configuration

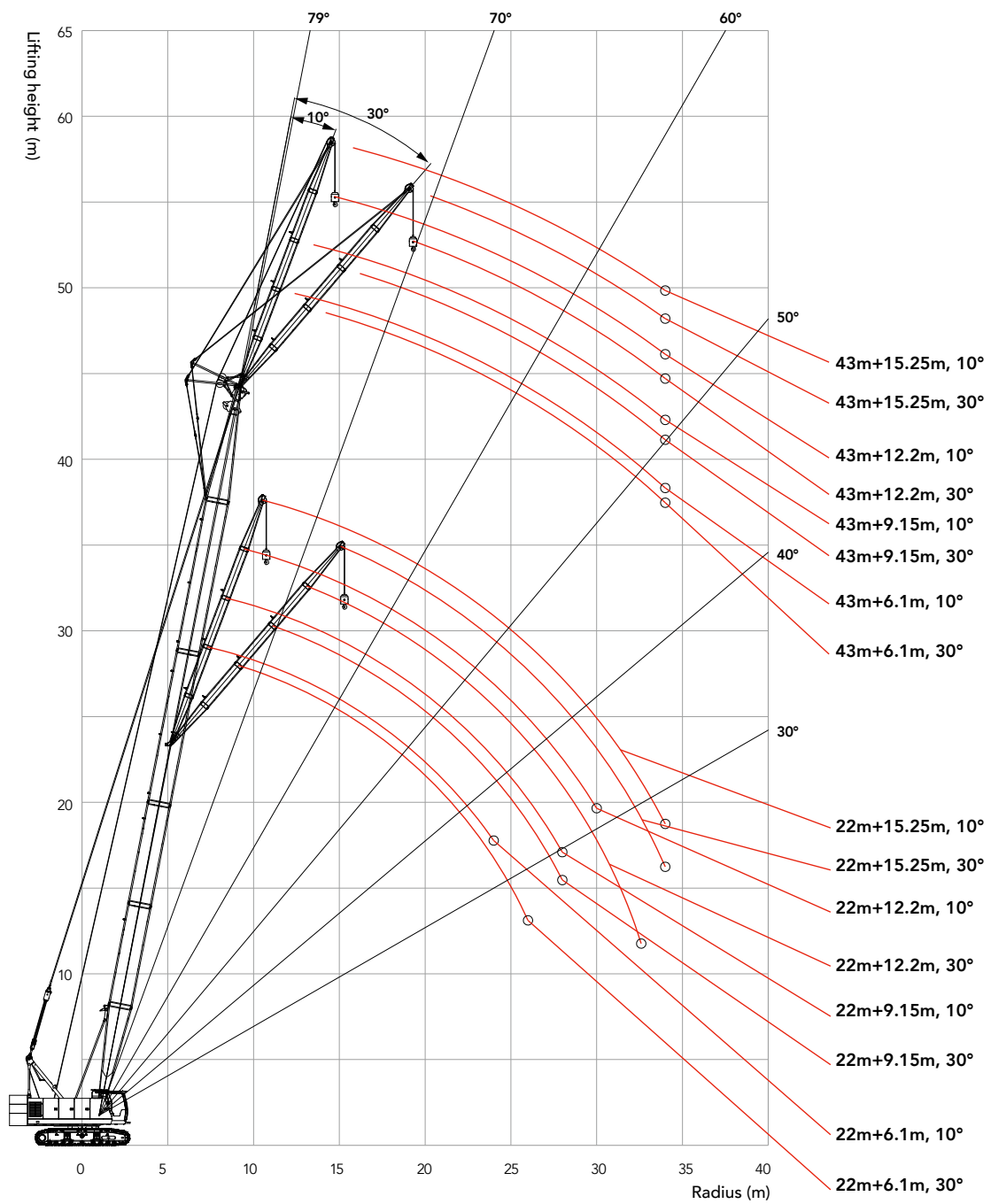

Load Chart of FJ Configuration

SCE600A Crawler Crane – FJ Load Chart 1/8									
Boom 22m Fixed jib 6.1m-15.25m Rear counterweight 16t									
Jib Length (m)	6.1		9.15		12.2		15.25		Jib Length (m)
Jib angle	10°	30°	10°	30°	10°	30°	10°	30°	Jib angle
R(m)									R(m)
8	7.00	9.8m × 6.5	9.2m × 7						8
10	7.00	6.30	7.00		10.3m × 4.5		11.4m × 4.5		10
12	7.00	6.00	7.00	4.80	4.50		4.40		12
14	7.00	5.50	7.00	4.65	4.50	4.00	4.40		14
16	7.00	5.00	6.50	4.45	4.50	3.50	4.00	3.50	16
18	6.00	5.00	5.80	4.25	4.15	3.50	4.00	3.25	18
20	4.90	5.00	5.00	4.05	3.95	3.50	3.85	3.05	20
22	4.30	4.35	4.35	3.85	3.85	3.50	3.60	2.90	22
24	3.90	4.00	4.00	3.50	3.65	3.25	3.35	2.85	24
26		3.85	3.85	3.45	3.55	3.20	3.25	2.75	26
28			3.05	3.05	3.05	3.05	3.05	2.70	28
30					2.75	2.75	2.75	2.65	30
32						2.50	2.50	2.20	32
34						32.6m × 2.5	2.30	2.15	34
Counterweight(t)	16	16	16	16	16	16	16	16	Counterweight(t)

Note: The shaded area is determined by the boom strength.

SCE600A Crawler Crane – FJ Load Chart 2/8									
Boom 25m Fixed jib 6.1m-15.25m Rear counterweight 16t									
Jib Length (m)	6.10		9.15		12.20		15.25		Jib Length (m)
Jib angle	10°	30°	10°	30°	10°	30°	10°	30°	Jib angle
R(m)									R(m)
8	8.6m × 7								8
10	7.00	10.4m × 6	7.00		10.9m × 4.5				10
12	7.00	6.00	7.00	12.5m × 4.8	4.50		12.1m × 4.5		12
14	7.00	5.50	7.00	4.65	4.50	14.5m × 4.0	4.40		14
16	7.00	5.50	6.50	4.45	4.35	3.50	4.25	16.6m × 3.5	16
18	6.00	5.00	5.50	4.25	4.15	3.50	4.00	3.25	18
20	4.90	5.00	5.00	4.05	3.95	3.50	3.85	3.05	20
22	4.30	4.35	4.35	3.85	3.85	3.50	3.60	2.90	22
24	3.90	4.00	4.00	3.50	3.65	3.25	3.35	2.85	24
26	3.80	3.85	3.85	3.45	3.55	3.20	3.25	2.75	26
28	3.00	3.05	3.05	3.05	3.05	3.05	3.05	2.70	28
30			2.65	2.75	2.75	2.75	2.75	2.65	30
32				2.40	2.40	2.40	2.40	2.20	32
34						2.25	2.20	2.15	34

Note: The shaded area is determined by the boom strength.

Unit: t

Load Chart of FJ Configuration

SCE600A Crawler Crane – FJ Load Chart 3/8									
Boom 28m Fixed jib 6.1m-15.25m Rear counterweight 16t									
Jib Length (m)	6.1		9.15		12.2		15.25		Jib Length (m)
Jib angle	10°	30°	10°	30°	10°	30°	10°	30°	Jib angle
R(m)									R(m)
8	9.3m × 7								8
10	7.00	11.1m × 6	10.4m × 7		11.6m × 4.5				10
12	7.00		6.00	7.00	13.1m × 5.0		4.50	12.7m × 4.0	
14	7.00	5.50	7.00	4.80	4.50	15.1m × 3.8		3.50	14
16	7.00	5.50	6.50	4.55	4.30	3.80	3.50	17.2m × 3.2	
18	6.00	5.00	5.50	4.05	4.05	3.70	3.50	3.20	18
20	5.00	5.00	5.00	3.85	3.95	3.55	3.45	3.05	20
22	4.50	4.50	4.50	3.70	3.85	3.45	3.25	2.95	22
24	4.00	4.00	4.00	3.50	3.65	3.25	3.35	2.85	24
26	3.80	3.85	3.85	3.45	3.55	3.20	3.25	2.75	26
28	3.00	3.05	3.05	3.05	3.05	3.05	3.05	2.70	28
30	2.60	2.65	2.65	2.75	2.75	2.75	2.75	2.65	30
32	31.3m × 2.3		2.30	2.30	2.35	2.40	2.35	2.20	32
34			2.05	2.10	2.10	2.15	2.10	2.15	34

Note: The shaded area is determined by the boom strength.

SCE600A Crawler Crane – FJ Load Chart 4/8									
Boom 31m Fixed jib 6.1m-15.25m Rear counterweight 16t									
Jib Length (m)	6.10		9.15		12.20		15.25		Jib Length (m)
Jib angle	10°	30°	10°	30°	10°	30°	10°	30°	Jib angle
R(m)									R(m)
10	7.00	11.7m × 6	11.0m × 7						10
12	7.00		6.00	7.00		12.2m × 4.5		13.3m × 4.0	
14	7.00	5.50	7.00	4.75	4.50		4.00		14
16	7.00	5.50	6.50	4.50	4.50	4.00	4.00		16
18	6.00	5.50	5.50	4.35	4.35	3.85	4.00	3.20	18
20	4.80	4.85	4.85	4.25	4.15	3.70	3.85	3.15	20
22	4.40	4.45	4.45	4.05	3.95	3.50	3.65	3.00	22
24	4.00	4.05	4.05	3.85	3.80	3.35	3.45	2.85	24
26	3.80	3.85	3.85	3.45	3.55	3.20	3.25	2.75	26
28	3.00	3.05	3.05	3.05	3.05	3.05	3.05	2.70	28
30	2.60	2.65	2.65	2.75	2.75	2.75	2.75	2.65	30
32	2.20	2.25	2.25	2.25	2.35	2.35	2.30	2.30	32
34		1.95	1.95	2.00	2.00	2.10	2.05	2.15	34

Note: The shaded area is determined by the boom strength.

Load Chart of FJ Configuration

SCE600A Crawler Crane – FJ Load Chart 5/8									
Boom 34m Fixed jib 6.1m-15.25m Rear counterweight 16t									
Jib Length (m)	6.1		9.15		12.2		15.25		Jib Length (m)
Jib angle	10°	30°	10°	30°	10°	30°	10°	30°	Jib angle
R(m)									R(m)
10	10.5m × 7		11.7m × 7						10
12	7.00	12.3m × 6	7.00		12.8m × 4.5		13.9m × 3.5		12
14	7.00	6.00	7.00	14.4m × 4.8	4.50		3.50		14
16	7.00	5.50	6.50	4.75	4.50	16.4m × 3.85	3.50		16
18	5.50	5.50	5.50	4.65	4.35	3.75	3.50	18.4m × 3.2	18
20	4.80	4.85	4.85	4.45	4.15	3.55	3.50	3.15	20
22	4.30	4.35	4.35	4.20	3.95	3.45	3.35	3.05	22
24	3.80	3.85	3.85	3.90	3.75	3.35	3.30	2.95	24
26	3.40	3.45	3.45	3.45	3.45	3.15	3.20	2.85	26
28	3.00	3.05	3.05	3.05	3.05	3.05	3.05	2.80	28
30	2.60	2.65	2.65	2.75	2.75	2.75	2.75	2.65	30
32	2.20	2.25	2.25	2.25	2.35	2.35	2.30	2.35	32
34	1.80	1.85	1.85	1.95	1.90	2.00	1.95	2.05	34

Note: The shaded area is determined by the boom strength.

SCE600A Crawler Crane – FJ Load Chart 6/8									
Boom 37m Fixed jib 6.1m-15.25m Rear counterweight 16t									
Jib Length (m)	6.10		9.15		12.20		15.25		Jib Length (m)
Jib angle	10°	30°	10°	30°	10°	30°	10°	30°	Jib angle
R(m)									R(m)
10	11.1m × 7								10
12	7.00	12.9m × 6	12.3m × 7		13.4m × 4.5				12
14	7.00	6.00	7.00	15.0m × 4.8	4.50		14.6m × 4.0		14
16	6.50	5.50	6.50	4.80	4.50	17.0m × 3.8	4.00		16
18	5.50	5.50	5.50	4.60	4.50	3.75	3.80	19.1m × 3.2	18
20	4.60	4.65	4.65	4.45	4.20	3.65	3.60	3.15	20
22	4.10	4.15	4.15	4.25	4.05	3.45	3.50	3.05	22
24	3.60	3.65	3.65	3.75	3.75	3.35	3.35	2.95	24
26	3.20	3.25	3.25	3.35	3.35	3.25	3.20	2.85	26
28	2.90	2.95	2.95	2.95	2.95	2.95	3.00	2.80	28
30	2.50	2.55	2.55	2.60	2.65	2.65	2.60	2.70	30
32	2.20	2.25	2.25	2.25	2.35	2.35	2.30	2.30	32
34	1.65	1.75	1.75	1.85	1.80	1.90	1.95	2.05	34

Note: The shaded area is determined by the boom strength.

Unit: t

Load Chart of FJ Configuration

SCE600A Crawler Crane – FJ Load Chart 7/8									
Boom 40m Fixed jib 6.1m-15.25m Rear counterweight 16t									
Jib Length (m)	6.1		9.15		12.2		15.25		Jib Length (m)
Jib angle	10°	30°	10°	30°	10°	30°	10°	30°	Jib angle
R(m)									R(m)
12	7.00	13.6m × 6	12.9m × 7						12
14	7.00	6.00	7.00	15.6m × 4.8	14.8m × 4.5		15.2m × 3.5		14
16	6.50	5.50	6.50	4.50	4.50		3.50		16
18	5.50	5.50	5.50	4.50	4.35	4.00	3.45	19.7m × 3.2	18
20	4.50	4.55	4.55	4.35	4.20	3.85	3.35	3.20	20
22	4.00	4.05	4.05	4.15	4.05	3.70	3.25	3.10	22
24	3.60	3.65	3.65	3.70	3.55	3.50	3.15	3.00	24
26	3.15	3.20	3.20	3.25	3.15	3.35	3.00	2.90	26
28	2.80	2.85	2.85	2.85	2.85	2.85	2.75	2.80	28
30	2.45	2.50	2.50	2.55	2.45	2.55	2.45	2.55	30
32	2.10	2.15	2.15	2.25	2.15	2.25	2.15	2.30	32
34	1.85	1.90	1.90	1.95	1.85	1.95	1.95	2.05	34

Note: The shaded area is determined by the boom strength.

SCE600A Crawler Crane – FJ Load Chart 8/8									
Boom 43m Fixed jib 6.1m-15.25m Rear counterweight 16t									
Jib Length (m)	6.10		9.15		12.20		15.25		Jib Length (m)
Jib angle	10°	30°	10°	30°	10°	30°	10°	30°	Jib angle
R(m)									R(m)
12	12.4m × 7		13.5m × 7						12
14	7.00	14.2m × 6	7.00		14.7m × 4.5		15.8m × 3.5		14
16	7.00	5.50	6.50	16.2m × 4.8	4.50		16.8m × 3.5		16
18	5.50	5.50	5.50	4.80	4.35	19.3m × 3.8	3.35		18
20	4.45	4.50	4.50	4.50	4.20	3.80	3.25	20.3m × 3.2	20
22	3.95	4.00	4.00	4.20	4.05	3.70	3.15	3.15	22
24	3.50	3.55	3.55	3.65	3.55	3.50	3.05	3.05	24
26	3.10	3.15	3.15	3.15	3.10	3.20	2.85	2.95	26
28	2.70	2.75	2.75	2.75	2.75	2.85	2.75	2.85	28
30	2.40	2.45	2.45	2.35	2.35	2.50	2.40	2.55	30
32	2.00	2.05	2.05	2.10	2.05	2.15	2.05	2.25	32
34	1.70	1.75	1.75	1.85	1.75	1.90	1.75	2.05	34

Note: The shaded area is determined by the boom strength.

Notes: Rated capacity of crawler crane

- ① The rated capacity in the load charts is calculated when the crane is parking on firm and level ground, lifting the load slowly and steadily.
- ② The shaded values are determined by strength.
- ③ The rated capacity values in the load charts are only valid when wind speed is lower than 9.8m/s.
- ④ The rated capacity in the load charts includes the weight of hook, wire rope and other riggings; therefore, the actual rated capacity shall deduct the weight of these components.
- ⑤ The crawlers must be extended during lifting.
- ⑥ The values in the load charts are valid for 360° swing.



Zhejiang Sany Equipment Co.,LTD

SANY Crawler Crane Industrial Park, No. 2188 Daishan Road, Wuxing District, Huzhou City, Zhejiang Province, P. R. China Zip 313028

Consulting sanycrane@sanygroup.com (Crane BU) / crd@sany.com.cn (IHQ)

After-sales Service 0086-400 6098 318

Reminder:

Any change in the technical parameters and configuration due to product modification or upgrade may occur without prior notice. The machine in the picture may include additional equipment. This brochure is for reference only, and goods in kind shall prevail.

Copyright at SANY. No part of this brochure may be copied or used for any purpose without written approval from SANY.

© Edited in April 2022

