



SCE2500TB

Telescopic Boom Crawler Crane 250 Tons Lifting Capacity

Quality Changes the World



Max. lifting moment: 860t · m
Max. boom length: 75.4m
Max. boom+jib length: 70.7m+43m

The parameters, pictures and standard/optional equipment are only for reference in this brochure, the actual machine is based on the effective price list and contract.



Telescopic Boom Crawler Crane SCE2500TB

P03	Main Characteristics	<ul style="list-style-type: none">▪ Product Specification▪ Safety Device
P08	Technical Parameters	<ul style="list-style-type: none">▪ Major Performance & Specifications▪ Outline Dimension▪ Transport Dimension▪ Transport Plan▪ Self-assembly Plane
P22	Configurations	<ul style="list-style-type: none">▪ Boom Configuration▪ H Configuration▪ HC Configuration▪ FJ Configuration▪ FJh Configuration



SCE2500TB
TELESCOPIC BOOM CRAWLER CRANE
250 TONS LIFTING CAPACITY

QUALITY CHANGES THE WORLD

Main Characteristics

- Page 04 Product Specification
- Page 06 Safety Devices

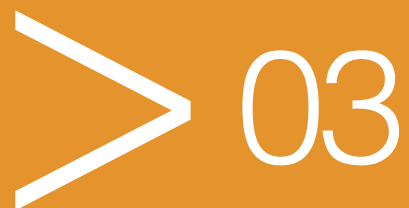

Product Specification



Engine

- Model: Cummins QSL9-C325 Diesel engine, Stage II
- Type: Four-stroke, water-cooled, vertical in-line 6-cylinder, direct injection, turbo-charger, intercooler.
- Displacement: 8.9L.
- Rated power: 242kW/1800rpm.
- Maximum torque: 1526N·m/1400rpm.
- Starting device: 24V-7.5kW.
- Cooling system: Temperature-adjustable, pressurized water cycle system.
- Air cleaner: Dry type main filter element, safety element core and resistance indicator.
- Throttle: Rotary type foot throttle, electrically controlled;
- Fuel filter: Replaceable paper filter element.
- Batter: Two 12Vx165Ah capacity batteries, connected in series;
- Fuel tank: 450L.

Electrical control system

- Adopt SYIC-II integrated control system independently researched and developed by Sany. This system is featured by high integration level, accurate operation and reliable quality.
- Control system: Composed of power system, engine system, main control system, Load Moment Limiter, auxiliary system and safety monitoring system. Data communication among controller, display and engine is conducted by CAN bus technology.
- Display: It can display the engine rotating speed, fuel volume, engine oil pressure, servo pressure, wind speed, engine working time, load weight, boom angle and other working parameters and working conditions.

Hydraulic system

- Main pump: Adopt open piston pump with large variable displacement.
- Swing pump: Variable close piston pump for swing.
- Control: The main piston pump of variable displacement, winch piston motor of limitless variable displacement, control system of hydraulic positive flow.
- Way of cooling: Heat exchanger, fan core and multi-stage cooling.
- Filter: Large flow, high accuracy filter, with bypass valve and indicator, which can remind the user to replace the filter element in time.
- Max. pressure of system:
Main load, aux. load, and travel system: 32MPa.
Boom hoist cylinder lifting: 32MPa.
Swing system: 24MPa.
Control system: 4.5MPa.
- Hydraulic oil tank capacity: 1000L.

Main and aux. load hoist mechanism

- Pump and motor: Dual-placement speed controlled energy efficient, combination of winch balance valve and anti-hook sliding technology, lifting or lowering the load steadily.
- Winch brake adopts concealed, normally closed, wet type and spring loaded fin type normally engaged brake, spring force braking, oil pressure released.
- Branded anti-self-rotating high-strength steel rope.
- Main and aux. load hoist winches adopt piston motor of fixed displacement to drive planetary reducer.

Main lifting mechanism	Rope speed (outermost layer)	0~140m/min
	Diameter of wire rope	Φ22mm
	Overall length of wire rope	350m
	Rated tensile force of single rope	10.5t
Auxiliary lifting mechanism	Rope speed (outermost layer)	0~140m/min
	Diameter of wire rope	Φ22mm
	Overall length of wire rope	280m
	Rated tensile force of single rope	10.5t

Boom hoist mechanism

- Double acting single piston rod hydraulic cylinder, fitted with safety balance valve, luffing angle: $-0.5^{\circ}\sim 80^{\circ}$, adopting dead-weight luffing system to reduce the energy consumption and improve the steadiness of luffing operation.

Swing mechanism

- Swing brake adopts concealed, normally closed, wet type and spring loaded fin type normally engaged brake, spring force braking oil pressure released.
- With integrated cushion valve, the swing system has free slip function to realize steady swing start and control, showing outstanding microinching performance.
- Unique swing cushion design ensures more stable braking.
- Swing drive: External gearing swing drive, capable of conducting 360° rotation, maximum rotation speed 1.5r/min. The maximum driving pressure can reach 20MPa, providing torque of 15.91t·m.
- Branded motor reducer, more reliable.
- Swing lockout: Locking device, to ensure that the superstructure can be locked in front and rear directions conveniently and reliably during off-work time and transportation.
- Swing bearing: Single row ball type bearing.



Product Specification

Counterweight

- The easily self-assembled and self-disassembled counterweights facilitate transport.
- The counterweights and trays pile up, conducting easy assembly, disassembly, and transport.
- Rear counterweight: Total weight: 60 t, performing self-assemble and self-disassemble function.
- Carbody counterweight: Fitted at front and rear of carbody, 10t*2.

Superstructure

- High strength steel welding frame structure, no torsional deformation, reasonable component layout, and convenient maintenance service.

Cab and control

- Novelty in cab design, artistic modeling and trim and large area glass window; fitted with low beam headlamp and rearview mirror to broaden horizon; installed with air conditioner and radio; the arrangement of seats, control handle and various control buttons is ergonomically designed to enable more conformable operation.
- Cab layout: Integrated touch screen of 10.4 inch, programmable smart buttons vibration handles are offered as optional and manmachine interaction interface are more perfect.
- Armrest box: Operation handle, electrical switch, emergency stop switch and ignition switch are installed on the left and right armrest boxes. The armrest box can be adjusted with the seat;
- Seat: Suspension type multi-mode multi-level regulated seat, fitted with unloading switch.
- Air conditioner: Cooling and heating air, optimized air passage and air port.
- Multiple cameras can be presented on the monitor at the same time to realize real-time monitoring of wire rope on each winch, conditions behind the counterweight and surrounding the machine.

Traveling drive

- Independent traveling drive device is adopted for each side of crawler frame, so as to realize straight travel, turning through reducer and drive wheel by travel motor.
- Traveling speed: The traveling can be switched between high speed and low speed, and the high speed can be up to 2.0km/h.
- Gradeability: 30%.

Traveling braking

- Concealed wet type and spring loaded fin type normally engaged brake, spring force braking, oil pressure released.

Telescopic crawler

- Pressure of 25MPa by aux. system pushes the cylinder to realize the extension and retracting of the crawlers. The crawlers are extended at work and retracted for transport with the whole basic machine.

Crawler tensioning

- The Jack pushes the guiding wheel and insert shims to adjust the crawler tension.

Steering system

- It can realize single track turning and pivot turning.

Track shoe

- High-strength alloy milled steel prolongs the service life of track shoes. Width 1100mm.

Track roller

- Maintenance-free track roller.

Outrigger

- Outrigger cylinder is offered to facilitate the track frame disassembly during jobsite transfer.

Product Specification



Main boom

- The boom is made of high-strength steel structure with U-shape section area, with seven sections, of which the basic boom is 14.4m and the max. boom length is 75.4m.
- Full power with single cylinder and plug for telescoping.

Fixed jib

- Fixed jib length of 43m.
- Installation angle includes 0°, 15° and 30°.

Heavy fix jib

- Heavy fix jib length of 3m.
- Installation angle includes 30°, 45°.

Boom tip pulley

- Welding structure, connected with the boom through pin, and used for auxiliary hook operation.

Lifting hook

Name	Capacity (t)	Pulley block	Weight (t)	Quantity
1	160	9	2.98	1
2	130	7	1.5	1
3	100	5	1.13	1
4	80	3	0.69	1
5	50	2	0.84	1
6	12.5	0	0.45	1

Note: the above-mentioned operating equipment is full-up configuration. The actual configurations are subject to contract.

Safety Device



Smart integrated load moment indicator

- The integrated LMI system is provided as standard offering to realize calibration-free and high safety and efficiency for equipment control to realize calibration-free and high safety and efficiency for equipment control.
- Based on lifting mechanics modes, the LMI computing system enables the loading precision, by no-loading calibration, to 0-10% and protects loading operation all-around; The system alarms once over-loaded to ensure safety.
- The LMI system can automatically detect the suspended load weight, working radius of the crane and the angle of boom, and compare rated load weight and actual load, working radius and boom angle. Under normal operation condition, it can intelligently judge and automatically cut off the crane action in dangerous direction, and have black box function to record the overload information.
- Its main components include: Monitor, controller, length and angle sensor, pressure sensor, etc.

Assembly/working mode switching switch

- In assembly mode, certain safety devices are disabled to facilitate crane assembly.
- In work mode, all safety limiting devices activate to protect the operation.

Emergency stop

- In emergency situation, this button is pressed down to cut off the power supply of the whole machine and all actions stop.

Over-hoist protection of the main/auxiliary load hoist

- Height limiter is equipped on the boom/jib tip, which prevents the hook lifting up too much. When the hook is lifted up to the limit height, the limit switch activates, alarm pops up on the monitor, buzzer on the right front control panel sends alarm, failure indicator light starts to flash and the hook hoisting action is cut off automatically.

Over-release protection of the main/auxiliary load hoist

- Three-wrap protector is installed on main and aux. load hoist to prevent over-release of wire rope. When the rope is paid out close to the last three wraps, the limit switch acts, and the system sends alarm through buzzer and show the alarm on the monitor, automatically cutting off the winch action.

Safety Device



Function lock

- If the function lock level is not in work position, all the other handles won't work, which prevents any mis-operation caused by accidental hitting.

Slewing lock

- Mechanical lock by pulling the pin, will lock the upperworks at the front part and the rear.

Hook latch

- The lifting hook is installed with a baffle plate to prevent wire rope from falling off.

GPS monitoring system

- Standard remote monitoring system: It can provide functions like GPS locating, GPRS data transfer, machine status inquiry and statistics, operating data monitoring and analysis, and remote diagnosis of failures.

Tri-color load indicator

- The load indicator light has three colors, i.e., green, yellow and red; and the real time load status is presented on the display. When the actual load is smaller than 90% of rated load, the green light is on; when the actual load is larger than 90% and smaller than 100%, the yellow light is on, the alarm light flashes and sends out intermittent sirens; when the actual load reaches 100% of rated load, the red light is on, the alarm light flashes and sends out continuous sirens. When the actual load reaches 102%, the system will automatically cut off the crane's dangerous operation.

Flash alarm

- When the LMI is powered on, the flash alarm will turn on.

Swing indicator light

- The swing indicator light flashes during traveling or swing.

Seat interlock

- If the operator leaves the seat, all control handles and switches will be disabled immediately to prevent any mis-operation due to accidental collision.

Illuminating light

- The machine is equipped with short-beam light in front of machine, lamps in operator's cab and lighting devices for night operation, as well as boom lights, so as to increase the visibility during work.

Rearview mirror

- It is installed at the front of the operator's cab, at the right handrail of the platform and near the winches.

Level indicator

- Electrical level indicator can show the inclination angle of superstructure on the monitor.

Closed circuit monitoring system

- There are two cameras and illuminating lights on the tail of rotating bed, which can show the rear part and winches working on the machine.



SCE2500TB
TELESCOPIC BOOM CRAWLER CRANE
250 TONS LIFTING CAPACITY

QUALITY CHANGES THE WORLD

Technical Parameters

- Page 09 Major Performance & Specifications
- Page 10 Outline Dimension
- Page 11 Transport Dimension
- Page 15 Transport Plan
- Page 19 Self-assembly Plane



Major Performance & Specifications

Major Performance & Specifications of SCE2500TB			
Specification		Unit	Parameter
Outline dimension	Full length of the whole crane	mm	17450
	Width of the whole machine (retracted)	mm	7350 (5200)
	Height of the whole machine	mm	4776
	Center distance of driving and engaged wheels	mm	7700
	Width of track shoe	mm	1100
H (main boom) configuration	Maximum rated lifting weight	t	250
	Main boom length	m	14.4~75.4
	Main boom angle	°	-0.5~80
	Maximum rated lifting moment	t·m	860
FJ (fixed jib) configuration	Longest main boom + longest jib	m	70.7+43
	Included angle between main boom and jib	°	0, 15, 30
FJh (Heavy fix jib) configuration	Longest main boom + longest jib	m	75.4+3
	Included angle between main boom and jib	°	30, 45
Working speed	Main/aux. load hoist rope speed	m/min	0~140
	Time to fully boom up/down	s	75/110
	Slewing speed	rpm	0~1.5
	No-load traveling speed	km/h	0~2.0
Engine	Model	/	QSL9-C325
	Rated power/speed	kW/rpm	242/1800
Wire rope	Diameter	mm	Φ22
Transportation parameters	Weight of the whole machine	t	192
	Maximum weight of single piece transportation	t	65
	Transportation dimension (long x width x height)	mm	17450×3000×3300
Other Parameters	Average ground bearing pressure	MPa	0.12
	Min. swing radius	mm	5650

Outline Dimension

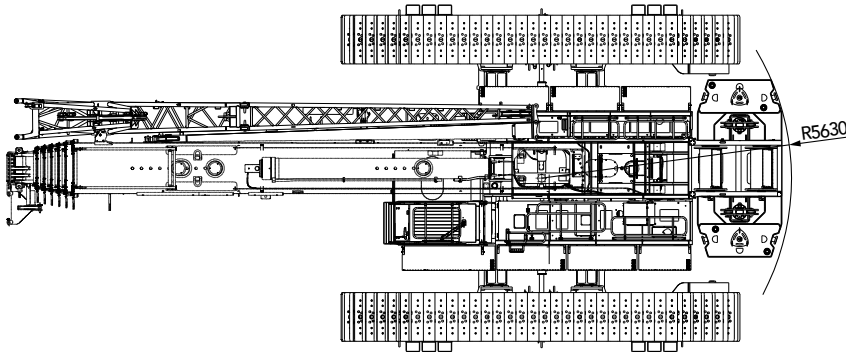
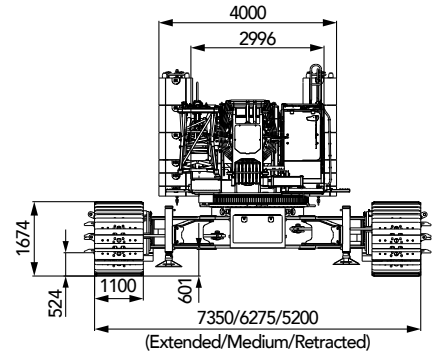
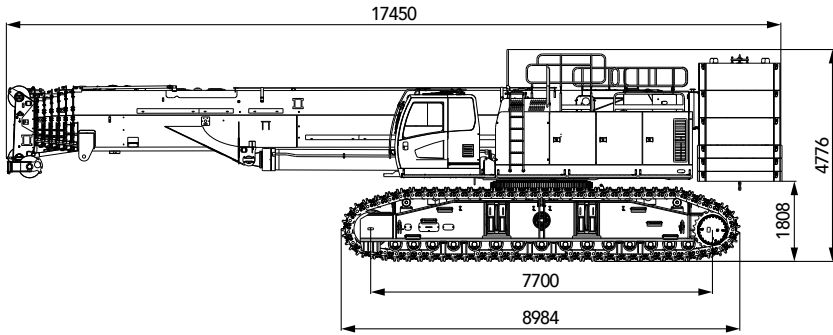

Transport Dimension

Note:

- ① . The component transportation dimension is schematic diagram, and is not drawn to scale. The marked dimension is design value, excluding the package.
- ② . The weight is design value, which may be slightly different because of manufacturing tolerance. Total rear counterweight: 60t, total carbody counterweight: 20t.
- ③ . After product upgrading of the Company, the outline dimension and weight of the components above may vary, and the new product shall prevail.

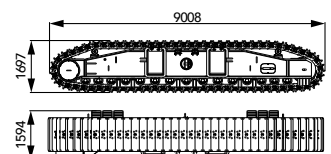
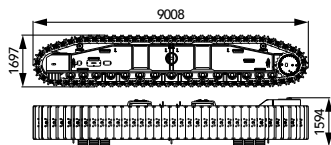
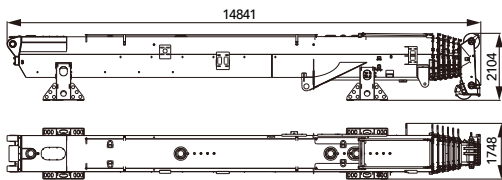
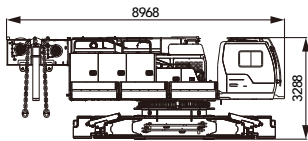
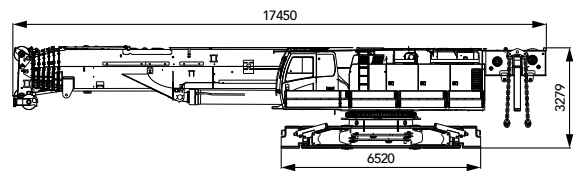
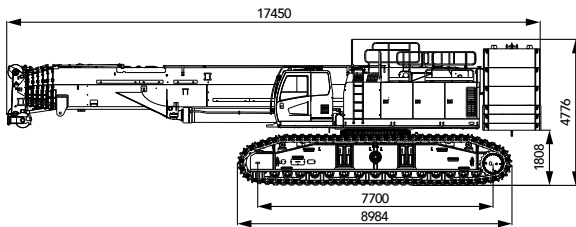

Whole machine

×1

Length (L)	17.45m
Width (W)	5.10m
Height (H)	4.78m
Weight	192.0t

Basic machine (with jib)

×1

Length (L)	17.45m
Width (W)	3.00m
Height (H)	3.30m
Weight	65.0t

Basic machine (without jib)

×1

Length (L)	8.97m
Width (W)	3.00m
Height (H)	3.30m
Weight	40.5t

Boom

×1

Length (L)	14.85m
Width (W)	1.75m
Height (H)	2.10m
Weight	24.5t

Left crawler

×1

Length (L)	9.01m
Width (W)	1.60m
Height (H)	1.70m
Weight	23.5t

Right crawler (2-bar track shoe)

×1

Length (L)	9.01m
Width (W)	1.60m
Height (H)	1.70m
Weight	23.5t

Transport Dimension

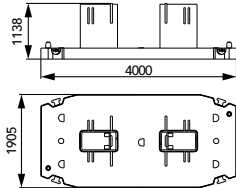

Counterweight tray

×1

Length (L)	4.00m
Width (W)	1.91m
Height (H)	1.14m
Weight	10.0t

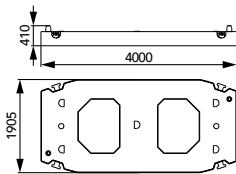

Rear counterweight

×2

Length (L)	4.00m
Width (W)	1.91m
Height (H)	0.41m
Weight	10.0t

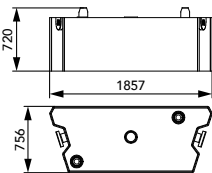

Rear counterweight

×6

Length (L)	1.90m
Width (W)	0.77m
Height (H)	0.71m
Weight	5.0t

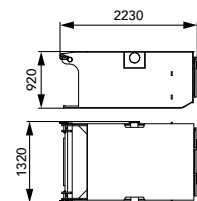

Carbody counterweight

×2

Length (L)	2.20m
Width (W)	1.32m
Height (H)	0.92m
Weight	10.0t

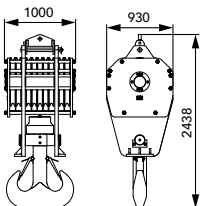

160t lifting hook

×1

Length (L)	2.44m
Width (W)	0.93m
Height (H)	1.00m
Weight	2.98t

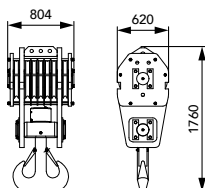

130t lifting hook

×1

Length (L)	1.82m
Width (W)	0.62m
Height (H)	0.90m
Weight	1.5t

Transport Dimension

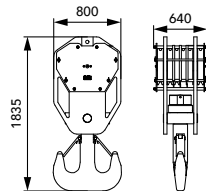

100t lifting hook ×1

Length (L)	1.84m
Width (W)	0.80m
Height (H)	0.64m
Weight	1.13t

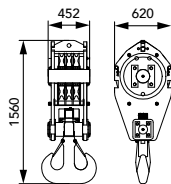

80t lifting hook ×1

Length (L)	1.56m
Width (W)	0.65m
Height (H)	0.45m
Weight	0.69t

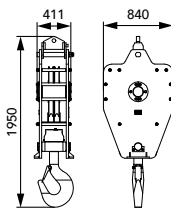

50t lifting hook ×1

Length (L)	1.95m
Width (W)	0.84m
Height (H)	0.41m
Weight	0.84t

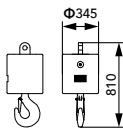

12.5t lifting hook ×1

Length (L)	0.81m
Width (W)	0.35m
Height (H)	0.35m
Weight	0.45t

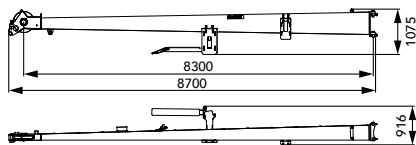

8.3m jib ×1

Length (L)	8.70m
Width (W)	0.92m
Height (H)	1.06m
Weight	0.69t

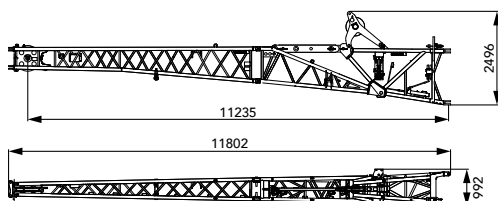

11.2m jib ×1

Length (L)	11.80m
Width (W)	0.99m
Height (H)	2.50m
Weight	1.85t

Transport Dimension

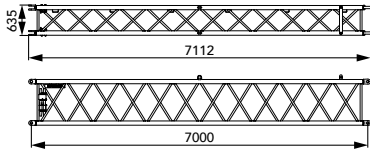

Fly jib extension

×1

Length (L)	7.11m
Width (W)	1.06m
Height (H)	0.63m
Weight	0.54t

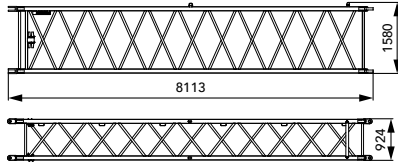

Main arm extension

×2

Length (L)	8.11m
Width (W)	1.56m
Height (H)	0.93m
Weight	0.70t

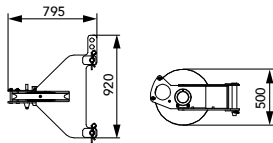

Arm tip sheave

×1

Length (L)	0.80m
Width (W)	0.92m
Height (H)	0.50m
Weight	0.11t

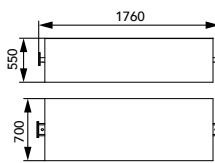

Elevating accessory box

×2

Length (L)	1.78m
Width (W)	0.70m
Height (H)	0.50m
Weight	0.51t

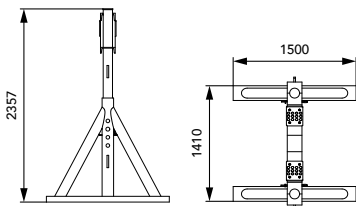

Boom timbering support

×1

Length (L)	1.50m
Width (W)	1.41m
Height (H)	2.36m
Weight	0.45t

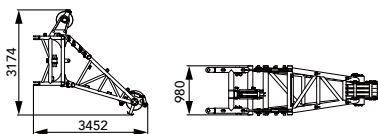

Heavy jib

×1

Length (L)	3.45m
Width (W)	0.98m
Height (H)	3.17m
Weight	1.03t

Transport Plan

■ Land transport:

65t: Basic machine

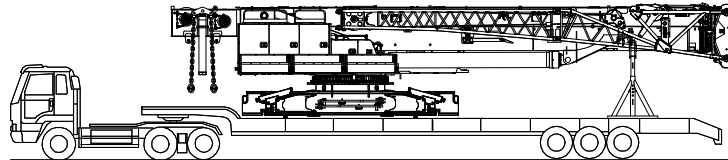

23.5t: Right crawler

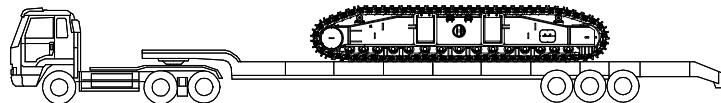

23.5t: Left crawler

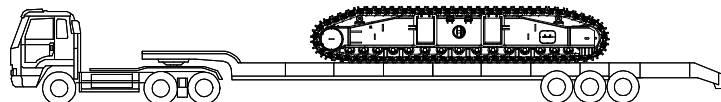

22.6t: Carbody counterweight×2 + 130t/100t lifting hook

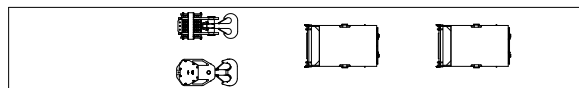
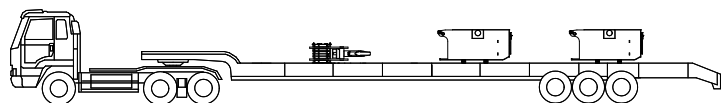

23.4t: Rear counterweight tray + rear counterweight block×2 + 160t/12.5t lifting hook

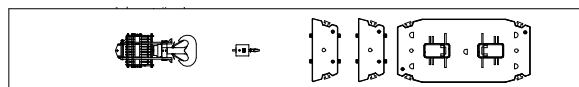
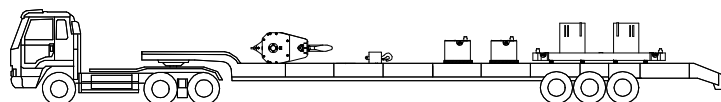

Transport Plan

22.6t: Rear counterweight block×2 + counterweight supporting box×2 + 80t/50t lifting hook

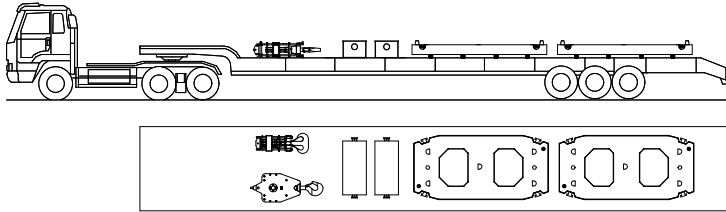

20.5t: Rear counterweight×4 + boom extension×1

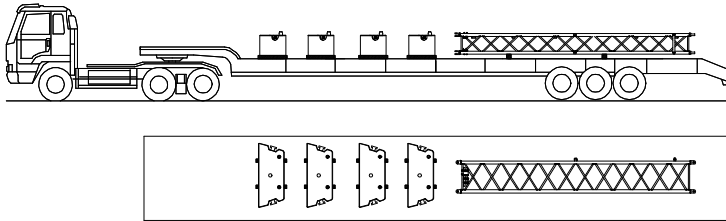

5.2t: Boom extension 2×2 + 3m heavy jib + 5A supporting box×2

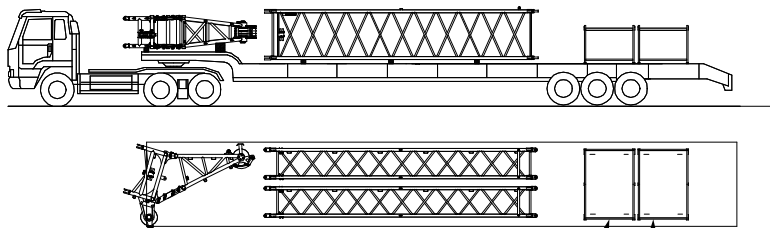

5A supporting box 1: 0.873t
handrails, guardrail, additional pulley assembly
Note:
1. Delete the thin partition in the middle
2. Put padding between the handrail and pulley block

5A supporting box: 1.884t
Random spare parts, random tools,
rubber sleeve assembly, delete the
thin partition in the middle

Transport Plan

■ Shipping:

34t: Basic machine

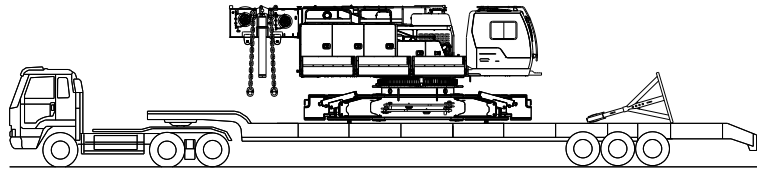

23.0t: Right crawler

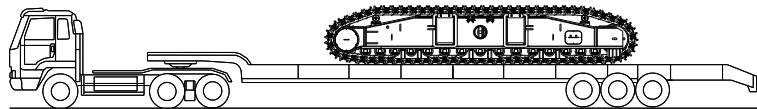

23.0t: Left crawler

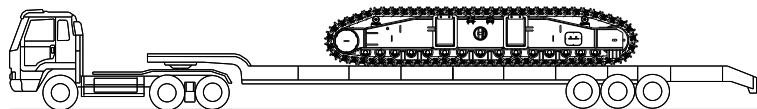

24.6t: Carbody counterweight×2 +130t/100t/80t/50t lifting hook

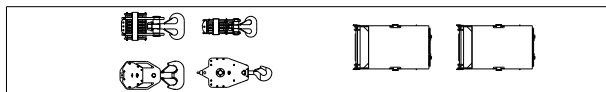
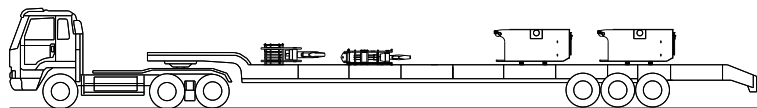

23.6t: Rear counterweight tray + rear counterweight block×2 + 12.5t/160t lifting hook

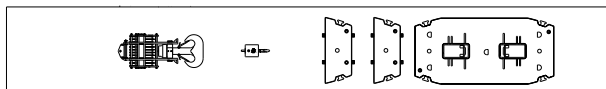
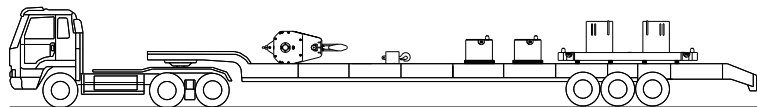

Transport Plan

23.2t: Rear counterweight×2 + jib + heightening supporting box

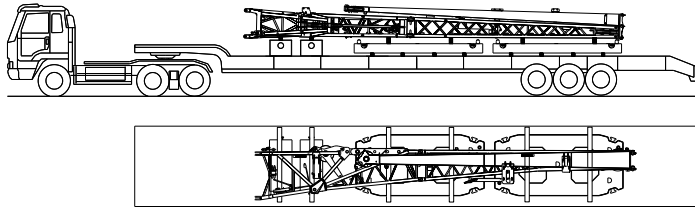

22.6t: Rear counterweight×4 + luffing cylinder + boom extension×1

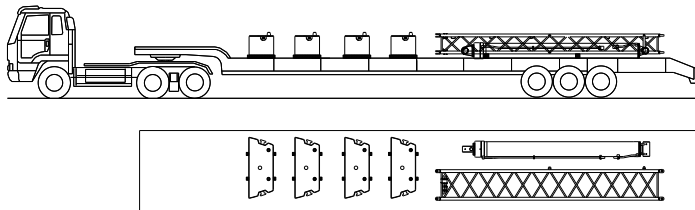

5.2t: Boom extension 2×2 + 3m heavy jib + 5A supporting box×2

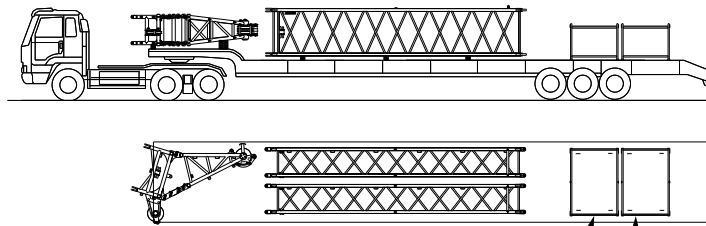

5A supporting box 1: 0.873t
handrails, guardrail, additional pulley assembly

Note:

1. Delete the thin partition in the middle
2. Put padding between the handrail and pulley block

5A supporting box: 1.884t
Random spare parts, random tools,
rubber sleeve assembly, delete the
thin partition in the middle

22.5t: Boom + Delivery tooling×2

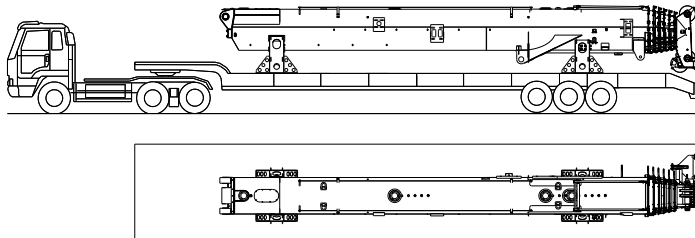

Self-assembly Plane

1

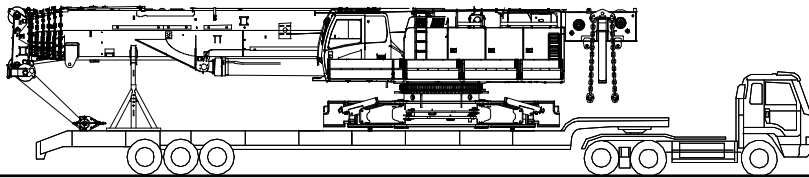

2

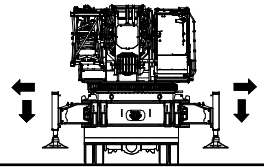

3

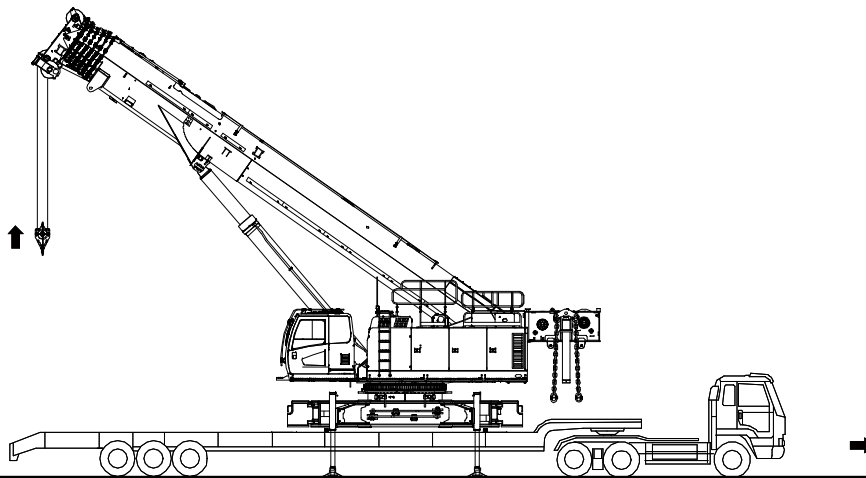

Self-assembly Plane

4
Crawler frame
installation

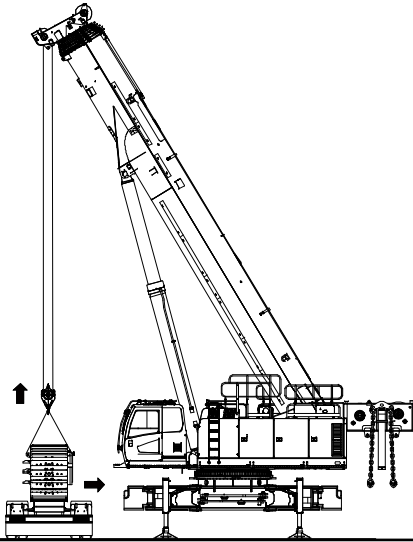

5
Crawler frame
installation

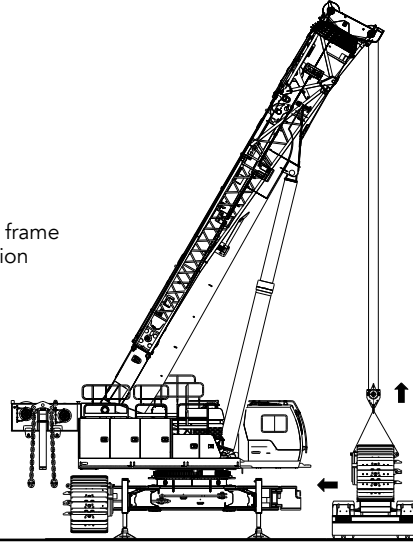

6
Carbody CW
installation

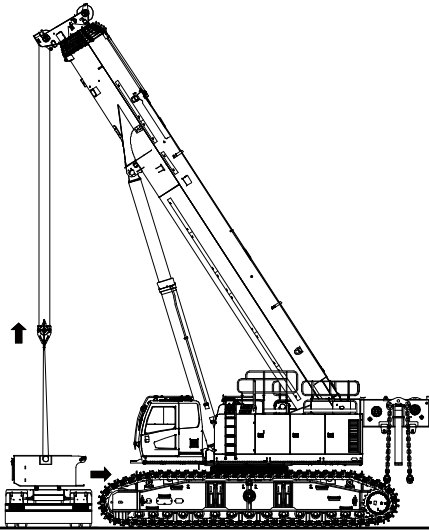

7
Carbody CW
installation

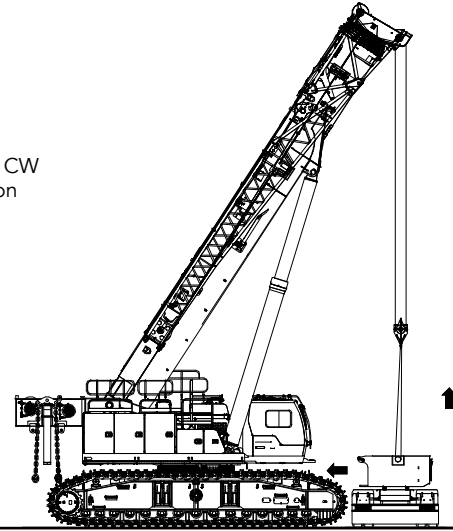

Self-assembly Plane

8
Rear CW installation

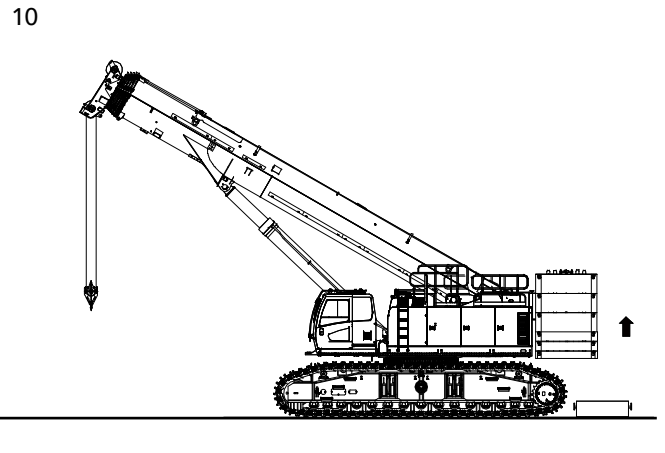
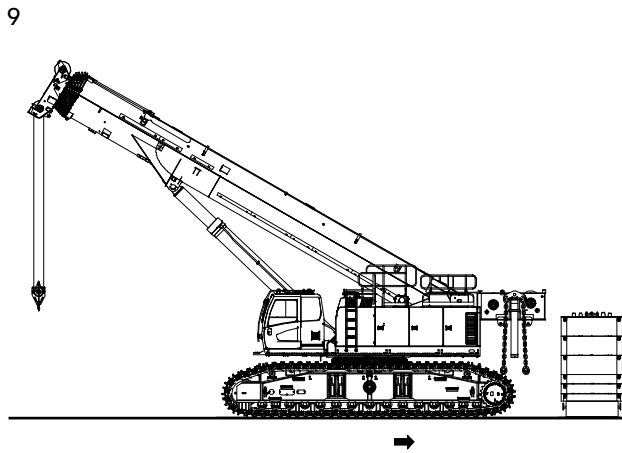
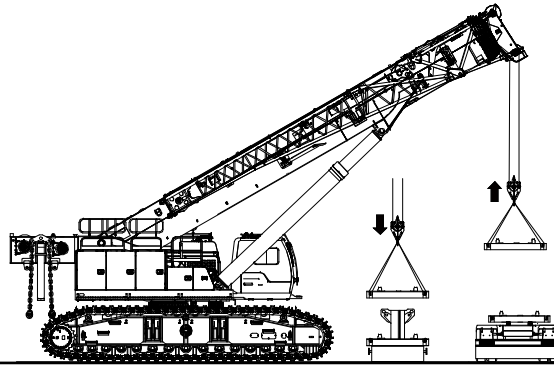



SCE2500TB TELESCOPIC BOOM CRAWLER CRANE 250 TONS LIFTING CAPACITY

QUALITY CHANGES THE WORLD

Configurations

- Page 23 Boom Combination
- Page 25 H Configuration
- Page 29 HC Configuration
- Page 36 FJ Configuration
- Page 47 FJh Configuration

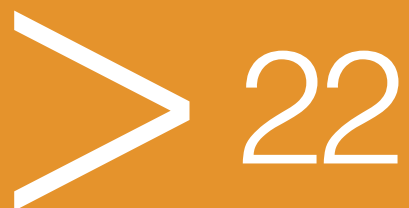

Boom Combination

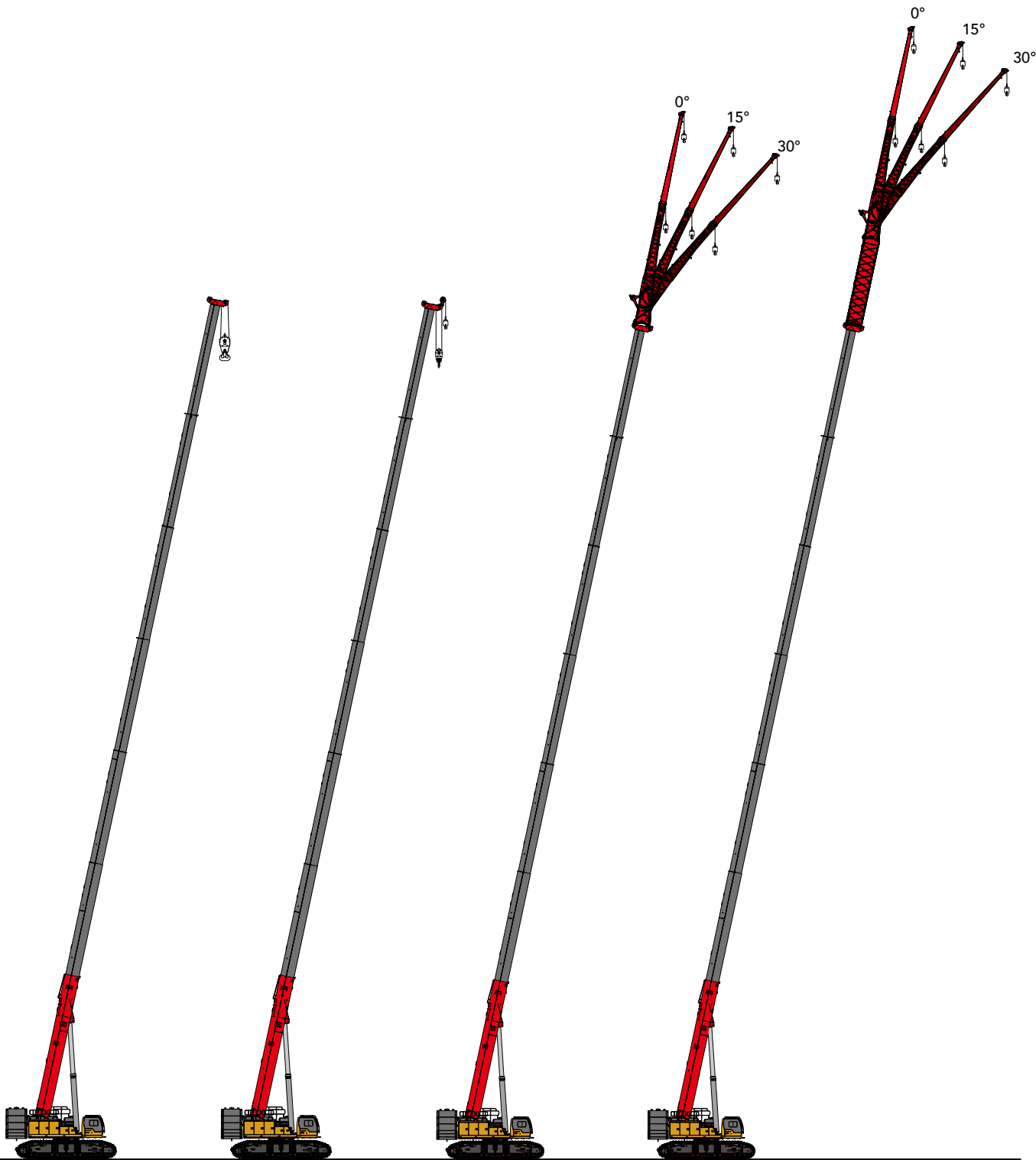

H Configuration

HC Configuration

FJ Configuration

FJ Configuration

Boom Combination

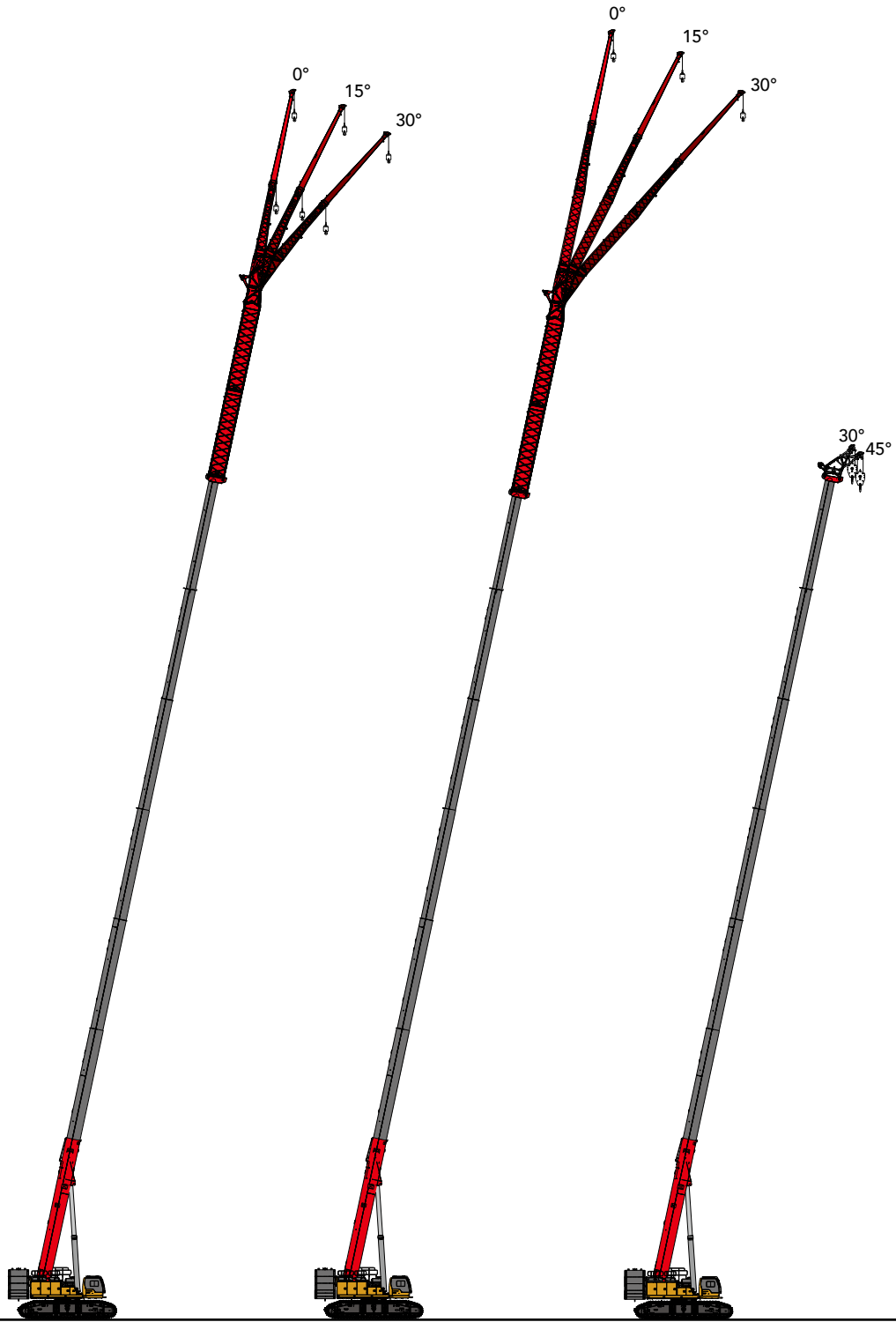

FJ Configuration

FJ Configuration

FJh Configuration

Working range of H

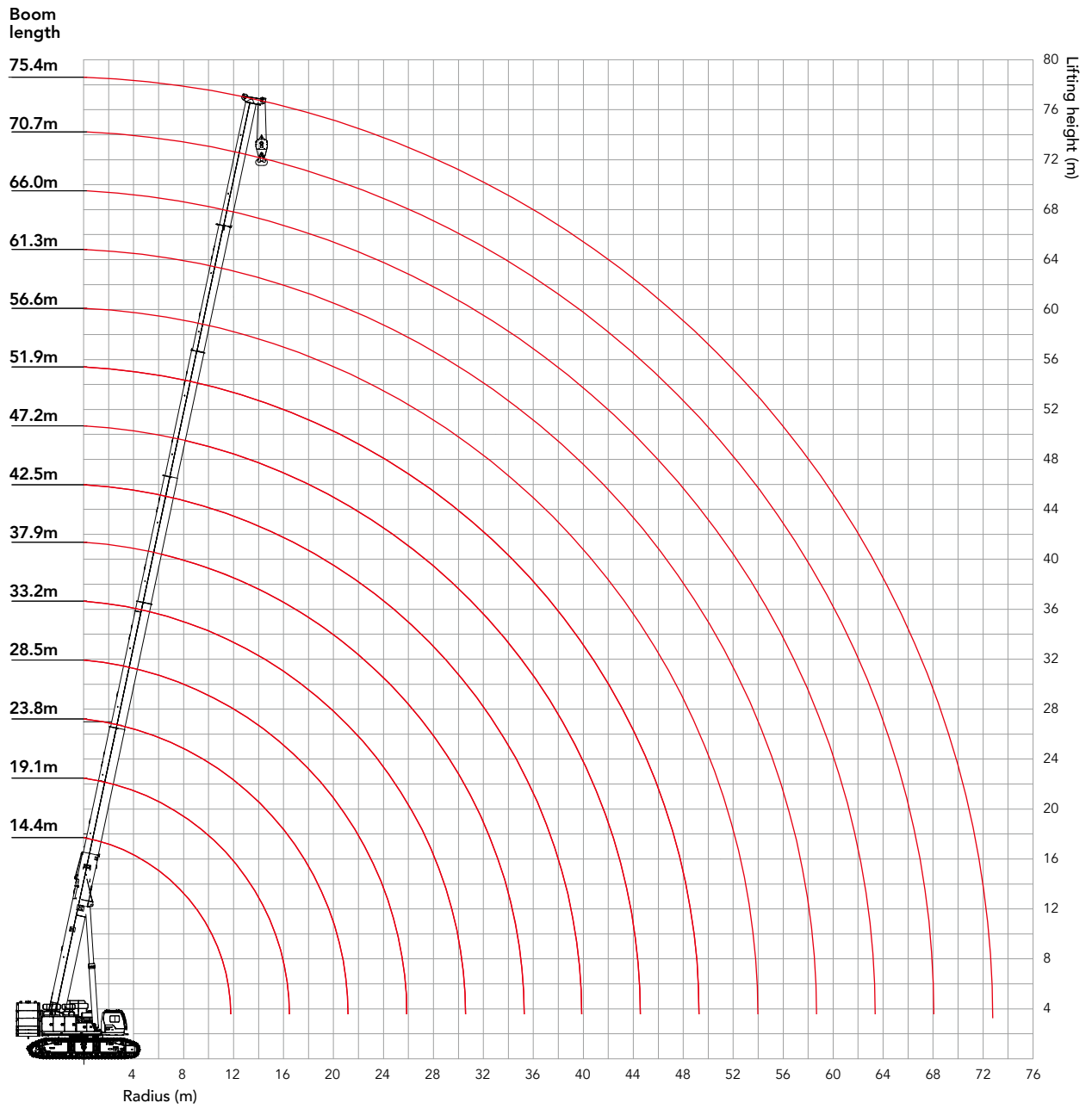

Load Chart of H Configuration

Load chart - H Configuration															
Rear counterweight 0t, Carbody counterweight 20t, Gauge 7.35m, Ground level 0.57°															
Radius (m)	Boom length (m)														Radius (m)
	14.4	19.1	23.8	28.5	33.2	37.9	42.5	47.2	51.9	56.6	61.3	66.0	70.7	75.4	
3	126.7	126.7													3
3.5	126.7	126.7	126.7												3.5
4	126.7	126.7	113.8												4
4.5	126.7	111	97.8	85.1											4.5
5	110	95.4	85.5	75.2											5
5.5	94.6	83.3	75.7	67.2	62.5										5.5
6	82.6	73.7	67.7	60.5	56.8										6
7	61.8	59.4	55.5	50.1	47.7	42.8									7
8	47.2	47.9	46.6	42.4	40.8	36.7	35.7								8
9	37.5	38.3	39.4	36.4	35.3	31.8	31.2	28.4							9
10	30.6	31.5	32.6	31.6	31	27.9	27.6	25.1	23.4						10
11	25.4	26.4	27.5	26.9	27.4	24.6	24.5	22.3	20.8	19.8					11
12		22.4	23.5	23	23.9	21.8	21.9	19.9	18.6	17.7	17.3				12
13		19.2	20.3	19.9	20.8	19.5	19.7	17.8	16.6	15.9	15.6				13
14		16.6	17.7	17.3	18.2	17.3	17.8	16	14.9	14.3	14	14			14
16			13.7	13.3	14.3	13.4	14.2	13	12.1	11.6	11.5	11.5	11.6	11.2	16
18			10.7	10.4	11.3	10.5	11.3	10.6	9.8	9.5	9.4	9.5	9.7	9.3	18
20			8.5	8.2	9.1	8.3	9.1	8.5	8	7.7	7.7	7.9	8.1	7.8	20
22				6.4	7.3	6.5	7.4	6.7	6.4	6.2	6.3	6.5	6.8	6.5	22
24				5	5.9	5.1	6	5.3	5.1	4.9	5	5.3	5.6	5.4	24
26					4.7	4	4.8	4.2	4	3.8	4	4.3	4.6	4.4	26
28					3.7	3	3.8	3.2	3	2.9	3	3.4	3.7	3.6	28
30						2.1	2.9	2.3	2.1	2.1	2.2	2.6	3	2.8	30
32						1.4	2.2	1.6	1.4	1.3	1.5	1.9	2.3	2.1	32
34							1.6	1				1.2	1.7	1.5	34
36							1						1.1	1	36
38															38
40															40
42															42
44															44
n	13	13	13	9	6	5	4	3	3	2	2	2	2	2	n
S2	0	0	0.46	0.46	0.46	0.46	0.46	0.92	0.92	0.92	0.92	0.92	0.92	1	S2
S3	0	0	0.46	0.46	0.46	0.46	0.46	0.46	0.92	0.92	0.92	0.92	0.92	1	S3
S4	0	0.46	0	0.46	0.46	0.46	0.46	0.46	0.46	0.92	0.92	0.92	0.92	1	S4
S5	0	0	0	0	0.46	0.46	0.46	0.46	0.46	0.46	0.92	0.92	0.92	1	S5
S6	0	0	0	0	0	0.46	0.46	0.46	0.46	0.46	0.46	0.92	0.92	1	S6
S7	0	0	0	0	0	0	0.46	0.46	0.46	0.46	0.46	0.46	0.92	1	S7

Load Chart of H Configuration

Load chart - H Configuration															
Rear counterweight 40t, Carbody counterweight 20t, Gauge 7.35m, Ground level 0.57°															
Radius (m)	Boom length (m)														Radius (m)
	14.4	19.1	23.8	28.5	33.2	37.9	42.5	47.2	51.9	56.6	61.3	66.0	70.7	75.4	
3	126.7	126.7													3
3.5	126.7	126.7	126.7												3.5
4	126.7	126.7	126.7												4
4.5	126.7	126.7	126.7	126.3											4.5
5	126.7	126.7	126.7	126.3											5
5.5	126.7	126.7	126.7	123.5	98.6										5.5
6	126.7	125.7	124.1	112.1	98.6										6
7	107.4	107.2	103.2	94.3	88.9	71.7									7
8	89	89.2	87.9	81	77.1	71	48.4								8
9	72.2	72.7	73.4	70.7	67.8	62.7	46.5	43.6							9
10	60.3	60.9	61.7	60.9	60.3	55.9	44.7	43.6	36						10
11	51.4	52.1	53	52.2	53	50.3	42.5	43.1	36	29.8					11
12		45.3	46.2	45.5	46.4	45.2	40.4	40.9	36	29.8	24.5				12
13		39.8	40.8	40.2	41	39.9	38.6	38.3	35	29.8	24.5				13
14		35.3	36.3	35.8	36.6	35.6	36.4	35.2	33.1	29.5	24.5	20.1			14
16			29.4	29	29.8	28.9	29.7	28.9	28.5	26.5	24.2	20.1	16.5	13.7	16
18			24.4	24	24.9	24	24.8	24	23.7	23.7	21.9	20.1	16.5	12.3	18
20			20.5	20.2	21.1	20.2	21	20.3	20	20	19.9	18.6	15.7	11.1	20
22				17.1	18	17.2	18	17.3	17.1	17.1	17.4	17	14.9	10	22
24				14.7	15.6	14.8	15.6	14.9	14.7	14.7	15	15.3	14.2	9.1	24
26					13.6	12.8	13.6	12.9	12.7	12.8	13	13.4	13.5	8.3	26
28					11.8	11.1	11.9	11.3	11.1	11.1	11.4	11.7	12.1	7.5	28
30						9.7	10.5	9.8	9.6	9.7	9.9	10.3	10.7	6.9	30
32						8.4	9.2	8.6	8.4	8.5	8.7	9.1	9.5	6.3	32
34							8.1	7.5	7.3	7.4	7.7	8	8.4	5.8	34
36							7.2	6.6	6.4	6.5	6.7	7.1	7.5	5.3	36
38							6.3	5.7	5.6	5.6	5.9	6.2	6.7	4.8	38
40								5	4.8	4.9	5.1	5.5	5.9	4.4	40
42								4.3	4.1	4.2	4.5	4.8	5.2	4.1	42
44									3.5	3.6	3.9	4.2	4.6	3.7	44
46									3	3.1	3.3	3.7	4.1	3.4	46
48										2.6	2.8	3.2	3.6	3.1	48
50										2.1	2.4	2.7	3.1	2.8	50
52											1.9	2.3	2.7	2.6	52
54											1.5	1.9	2.3	2.3	54
56											1.2	1.6	2	2	56
58												1.2	1.6	1.6	58
60													1.3	1.3	60
62														1	62
n	13	13	13	10	7	7	5	5	4	3	3	2	2	2	n
S2	0	0	0.46	0.46	0.46	0.46	0.46	0.92	0.92	0.92	0.92	0.92	0.92	1	S2
S3	0	0	0.46	0.46	0.46	0.46	0.46	0.46	0.92	0.92	0.92	0.92	0.92	1	S3
S4	0	0.46	0	0.46	0.46	0.46	0.46	0.46	0.46	0.92	0.92	0.92	0.92	1	S4
S5	0	0	0	0	0.46	0.46	0.46	0.46	0.46	0.46	0.92	0.92	0.92	1	S5
S6	0	0	0	0	0	0.46	0.46	0.46	0.46	0.46	0.46	0.92	0.92	1	S6
S7	0	0	0	0	0	0	0.46	0.46	0.46	0.46	0.46	0.46	0.92	1	S7

Load Chart of H Configuration

Load chart - H Configuration																
Rear counterweight 60t, Carbody counterweight 20t, Gauge 7.35m, Ground level 0.57°																
Radius (m)	Boom length (m)															Radius (m)
	14.4	14.4	19.1	23.8	28.5	33.2	37.9	42.5	47.2	51.9	56.6	61.3	66.0	70.7	75.4	
3	250*	126.7	126.7													3
3.5	237*	126.7	126.7	126.7												3.5
4	215*	126.7	126.7	126.7												4
4.5	191.1*	126.7	126.7	126.7	126.3											4.5
5	172*	126.7	126.7	126.7	126.3											5
5.5	156.4*	126.7	126.7	126.7	126.3	98.6										5.5
6	133.3*	126.7	125.7	126.7	126.3	98.6										6
7	114.3*	121.6	114.6	123.5	122.9	96.6	71.7									7
8	100*	104.1	104.9	106	105.6	90	71.4	48.4								8
9	88.9	90.6	91.5	92.6	92.1	84.4	67.6	46.5	43.6							9
10	80	80	80.8	81.9	81.5	79.4	64.1	44.7	43.6	36						10
11	72.7	71.3	72.2	73.3	72.9	73.9	61	42.5	43.1	36	29.8					11
12			65.1	66.2	65.8	66.8	58.3	40.4	40.9	36	29.8	24.5				12
13			59.1	60.2	59.8	60.8	55.7	38.6	38.9	35	29.8	24.5				13
14			53.9	55	54.6	55.6	53.2	37	36.9	33.1	29.5	24.5	20.1			14
16				45.6	45.3	46.5	45.1	34.1	33.5	29.8	26.5	24.2	20.1	16.5	13.7	16
18				38	37.7	38.9	38	31.6	30.6	27	24	21.9	20.1	16.5	12.3	18
20				32.2	32	33.2	32.3	29.5	28.1	24.7	21.9	19.9	18.6	15.7	11.1	20
22					27.4	28.6	27.7	27.7	25.9	22.7	20	18.2	17	14.9	10	22
24					23.7	24.9	24.1	25.1	24	20.9	18.4	16.8	15.7	14.2	9.1	24
26						21.9	21.1	22.1	21.4	19.4	17	15.5	14.4	13.5	8.3	26
28						19.3	18.5	19.5	18.9	18	15.8	14.3	13.4	12.7	7.5	28
30							16.4	17.4	16.7	16.5	14.7	13.3	12.4	11.8	6.9	30
32							14.5	15.5	14.9	14.7	13.7	12.4	11.5	11	6.3	32
34								13.9	13.2	13	12.8	11.5	10.8	10.3	5.8	34
36								12.5	11.8	11.6	11.8	10.8	10	9.6	5.3	36
38								11.2	10.6	10.4	10.5	10.1	9.4	9	4.8	38
40									9.4	9.3	9.4	9.5	8.8	8.4	4.4	40
42									8.4	8.3	8.4	8.7	8.3	7.9	4.1	42
44										7.3	7.5	7.8	7.8	7.5	3.7	44
46										6.5	6.7	7	7.3	7	3.4	46
48											5.9	6.3	6.7	6.6	3.1	48
50											5.2	5.6	6	6.2	2.8	50
52												4.9	5.4	5.9	2.6	52
54												4.4	4.8	5.3	2.3	54
56												3.8	4.3	4.8	2.1	56
58													3.8	4.3	1.9	58
60													3.3	3.8	1.7	60
62														3.4	1.6	62
64														3	1.4	64
66															1.3	66
68															1.1	68
n	26.0	13	13	13	13	10	7	5	5	4	3	3	2	2	2	n
S2	0	0	0	0.46	0.46	0.46	0.46	0.46	0.46	0.92	0.92	0.92	0.92	0.92	1	S2
S3	0	0	0	0.46	0.46	0.46	0.46	0.46	0.46	0.92	0.92	0.92	0.92	0.92	1	S3
S4	0	0	0.46	0	0.46	0.46	0.46	0.46	0.46	0.46	0.92	0.92	0.92	0.92	1	S4
S5	0	0	0	0	0	0.46	0.46	0.46	0.46	0.46	0.46	0.92	0.92	0.92	1	S5
S6	0	0	0	0	0	0	0.46	0.46	0.46	0.46	0.46	0.46	0.92	0.92	1	S6
S7	0	0	0	0	0	0	0	0.46	0.46	0.46	0.46	0.46	0.46	0.92	1	S7

* Special equipment required on the head of boom.

Working range of HC

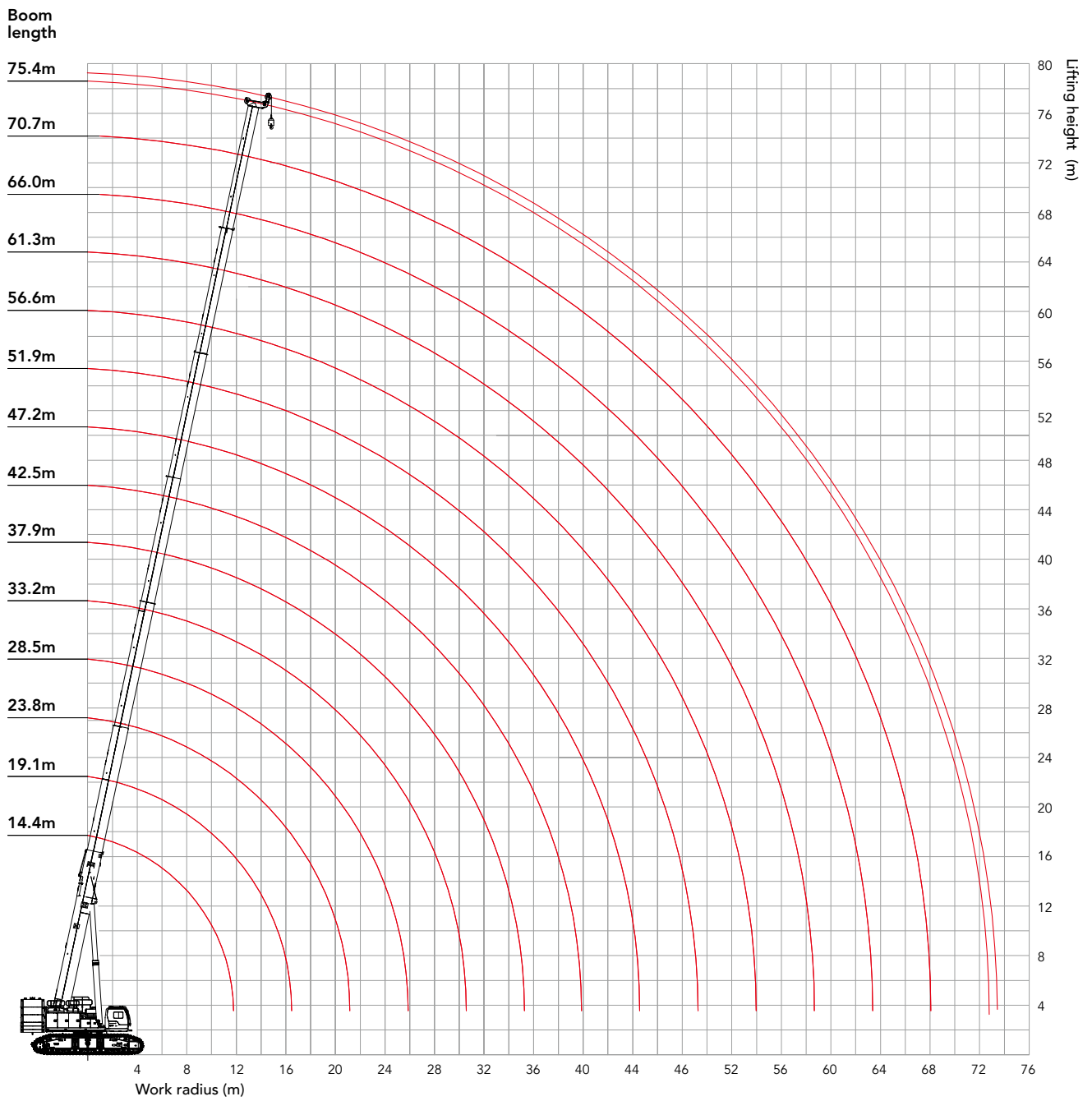

Load Chart of HC Configuration

Load chart - HC Configuration (Double hooks, using main hook)															
Rear counterweight 0t, Carbody counterweight 20t, Gauge 7.35m, Ground level 0.57°															
Radius (m)	Boom length (m)														Radius (m)
	14.4	19.1	23.8	28.5	33.2	37.9	42.5	47.2	51.9	56.6	61.3	66.0	70.7	75.4	
3	126.2	126.2													3
3.5	126.2	126.2	126.2												3.5
4	126.2	126.2	113.3												4
4.5	126.2	110.5	97.3	84.6											4.5
5	109.5	94.9	85	74.7											5
5.5	94.1	82.8	75.2	66.7	62.1										5.5
6	82.1	73.2	67.2	60	56.3										6
7	61.5	58.9	55	49.6	47.2	42.3									7
8	46.8	47.5	46.1	41.9	40.3	36.2	35.2								8
9	37.2	38	39	35.9	34.9	31.4	30.8	27.9							9
10	30.2	31.1	32.2	31.1	30.5	27.4	27.1	24.6	22.9						10
11	25.1	26	27.1	26.6	26.9	24.1	24.1	21.8	20.3	19.4					11
12		22	23.2	22.6	23.6	21.4	21.5	19.4	18.1	17.3	16.8				12
13		18.9	20	19.5	20.5	19	19.2	17.3	16.2	15.5	15.1				13
14		16.2	17.4	16.9	17.9	16.9	17.3	15.5	14.5	13.9	13.6	13.5			14
16			13.4	13	13.9	13	13.9	12.5	11.6	11.2	11	11.1	11.2	10.7	16
18			10.4	10.1	11	10.2	11	10.1	9.4	9	9	9.1	9.3	8.9	18
20			8.1	7.8	8.8	8	8.8	8.1	7.5	7.2	7.2	7.4	7.7	7.4	20
22				6.1	7	6.2	7	6.4	5.9	5.7	5.8	6	6.3	6.1	22
24				4.6	5.5	4.8	5.6	5	4.6	4.5	4.6	4.8	5.2	4.9	24
26					4.4	3.6	4.4	3.8	3.5	3.4	3.5	3.8	4.2	4	26
28					3.3	2.6	3.4	2.8	2.5	2.4	2.6	2.9	3.3	3.1	28
30						1.8	2.6	2	1.7	1.6	1.8	2.1	2.5	2.4	30
32						1	1.9	1.3			1.1	1.4	1.8	1.7	32
34							1.2						1.2	1.1	34
36															36
38															38
40															40
42															42
n	13	13	13	9	6	5	4	3	3	2	2	2	2	2	n
S2	0	0	0.46	0.46	0.46	0.46	0.46	0.92	0.92	0.92	0.92	0.92	0.92	1	S2
S3	0	0	0.46	0.46	0.46	0.46	0.46	0.46	0.92	0.92	0.92	0.92	0.92	1	S3
S4	0	0.46	0	0.46	0.46	0.46	0.46	0.46	0.46	0.92	0.92	0.92	0.92	1	S4
S5	0	0	0	0	0.46	0.46	0.46	0.46	0.46	0.46	0.92	0.92	0.92	1	S5
S6	0	0	0	0	0	0.46	0.46	0.46	0.46	0.46	0.46	0.92	0.92	1	S6
S7	0	0	0	0	0	0	0.46	0.46	0.46	0.46	0.46	0.46	0.92	1	S7

Load Chart of HC Configuration

Load chart - HC Configuration (Double hooks, using main hook)																
Rear counterweight 40t, Carbody counterweight 20t, Gauge 7.35m, Ground level 0.57°																
Radius (m)	Boom length (m)														Radius (m)	
	14.4	19.1	23.8	28.5	33.2	37.9	42.5	47.2	51.9	56.6	61.3	66.0	70.7	75.4		
3	126.2	126.2													3	
3.5	126.2	126.2	126.2												3.5	
4	126.2	126.2	126.2												4	
4.5	126.2	126.2	126.2	126.2											4.5	
5	126.2	126.2	126.2	126.2											5	
5.5	126.2	126.2	126.2	123.1	98.6										5.5	
6	126.2	125.2	123.6	111.6	98.6										6	
7	107.4	107.2	102.7	93.8	88.4	71.1									7	
8	88.6	88.8	87.5	80.5	76.6	70.5	47.9								8	
9	71.9	72.3	73.1	70.2	67.3	62.2	46	43.1							9	
10	60	60.5	61.4	60.5	59.9	55.4	44.2	43.1	35.5						10	
11	51.1	51.7	52.7	51.9	52.7	49.8	42	42.6	35.5	29.3					11	
12		44.9	45.9	45.2	46	44.8	40	40.4	35.5	29.3	24				12	
13		39.4	40.4	39.8	40.7	39.6	38.1	37.9	34.5	29.3	24				13	
14		35	36	35.4	36.3	35.2	36	34.8	32.6	29	24	19.6			14	
16			29.1	28.6	29.5	28.5	29.3	28.5	28.2	26	23.8	19.6	16	13.2	16	
18			24.1	23.7	24.5	23.6	24.4	23.7	23.4	23.4	21.4	19.6	16	11.8	18	
20			20.2	19.8	20.7	19.9	20.7	19.9	19.7	19.7	19.5	18.1	15.2	10.6	20	
22				16.8	17.7	16.9	17.7	17	16.7	16.8	17	16.6	14.4	9.5	22	
24				14.4	15.2	14.5	15.3	14.6	14.4	14.4	14.6	15	13.7	8.6	24	
26					13.2	12.5	13.2	12.6	12.4	12.4	12.7	13	13	7.8	26	
28					11.5	10.8	11.6	10.9	10.7	10.8	11	11.4	11.8	7.1	28	
30						9.3	10.1	9.5	9.3	9.4	9.6	10	10.4	6.4	30	
32						8.1	8.9	8.3	8.1	8.1	8.4	8.8	9.2	5.8	32	
34							7.8	7.2	7	7.1	7.3	7.7	8.1	5.3	34	
36							6.8	6.2	6.1	6.1	6.4	6.7	7.1	4.8	36	
38							6	5.4	5.2	5.3	5.6	5.9	6.3	4.4	38	
40								4.6	4.5	4.6	4.8	5.2	5.6	4	40	
42								4	3.8	3.9	4.1	4.5	4.9	3.6	42	
44									3.2	3.3	3.5	3.9	4.3	3.2	44	
46									2.6	2.7	3	3.3	3.7	2.9	46	
48										2.2	2.5	2.8	3.2	2.6	48	
50										1.8	2	2.4	2.8	2.4	50	
52											1.6	2	2.4	2.1	52	
54											1.2	1.6	2	1.9	54	
56												1.2	1.6	1.6	56	
58													1.3	1.3	58	
60														1	1	60
n	13	13	13	13	10	7	5	5	4	3	3	2	2	2	n	
S2	0	0	0.46	0.46	0.46	0.46	0.46	0.92	0.92	0.92	0.92	0.92	0.92	1	S2	
S3	0	0	0.46	0.46	0.46	0.46	0.46	0.46	0.92	0.92	0.92	0.92	0.92	1	S3	
S4	0	0.46	0	0.46	0.46	0.46	0.46	0.46	0.46	0.92	0.92	0.92	0.92	1	S4	
S5	0	0	0	0	0.46	0.46	0.46	0.46	0.46	0.46	0.92	0.92	0.92	1	S5	
S6	0	0	0	0	0	0.46	0.46	0.46	0.46	0.46	0.46	0.92	0.92	1	S6	
S7	0	0	0	0	0	0	0.46	0.46	0.46	0.46	0.46	0.46	0.92	1	S7	

Load Chart of HC Configuration

Load chart - HC Configuration (Double hooks, using main hook)															
Rear counterweight 60t, Carbody counterweight 20t, Gauge 7.35m, Ground level 0.57°															
Radius (m)	Boom length (m)														Radius (m)
	14.4	19.1	23.8	28.5	33.2	37.9	42.5	47.2	51.9	56.6	61.3	66.0	70.7	75.4	
3	126.2	126.2													3
3.5	126.2	126.2	126.2												3.5
4	126.2	126.2	126.2												4
4.5	126.2	126.2	126.2	126.2											4.5
5	126.2	126.2	126.2	126.2											5
5.5	126.2	126.2	126.2	126.2	98.6										5.5
6	126.2	125.2	126.2	126.2	98.6										6
7	118.8	114.1	118.6	115.9	96.1	71.1									7
8	102.1	102	102.4	99.8	89.5	70.9	47.9								8
9	89.2	89.3	89.8	87.4	83.6	67.1	46	43.1							9
10	74.8	75.3	76	75	74.6	63.6	44.2	43.1	35.5						10
11	64.1	64.6	65.4	64.6	65.3	60.5	42	42.6	35.5	29.3					11
12		56.3	57.2	56.5	57.2	56	40	40.4	35.5	29.3	24				12
13		49.7	50.6	50	50.8	49.6	38.1	38.4	34.5	29.3	24				13
14		44.3	45.2	44.7	45.5	44.4	36.5	36.4	32.6	29	24	19.6			14
16			37	36.5	37.3	36.3	33.6	33	29.3	26	23.8	19.6	16	13.2	16
18			30.9	30.4	31.3	30.4	31.1	30.1	26.5	23.5	21.4	19.6	16	11.8	18
20			26.2	25.8	26.7	25.8	26.6	25.9	24.2	21.4	19.5	18.1	15.2	10.6	20
22				22.2	23	22.2	23	22.3	22	19.5	17.8	16.6	14.4	9.5	22
24				19.2	20.1	19.3	20.1	19.4	19.1	17.9	16.3	15.2	13.7	8.6	24
26					17.6	16.9	17.7	17	16.8	16.5	15	14	13	7.8	26
28					15.6	14.8	15.6	15	14.8	14.8	13.8	12.9	12.3	7.1	28
30						13.1	13.9	13.3	13	13.1	12.8	11.9	11.4	6.4	30
32						11.6	12.4	11.8	11.6	11.6	11.9	11.1	10.5	5.8	32
34							11.1	10.5	10.3	10.3	10.6	10.3	9.8	5.3	34
36							9.9	9.3	9.1	9.2	9.4	9.6	9.1	4.8	36
38							8.9	8.3	8.1	8.2	8.4	8.8	8.5	4.4	38
40								7.4	7.2	7.3	7.5	7.9	8	4	40
42								6.6	6.4	6.5	6.7	7.1	7.5	3.6	42
44									5.7	5.7	6	6.4	6.8	3.2	44
46									5	5.1	5.3	5.7	6.1	2.9	46
48										4.5	4.7	5.1	5.5	2.6	48
50										3.9	4.2	4.5	4.9	2.4	50
52											3.7	4	4.4	2.1	52
54											3.2	3.6	4	1.9	54
56											2.8	3.1	3.5	1.7	56
58												2.7	3.1	1.5	58
60												2.4	2.8	1.3	60
62													2.4	1.1	62
64														2.1	64
n	13	13	13	13	10	7	5	5	4	3	3	2	2	2	n
S2	0	0	0.46	0.46	0.46	0.46	0.46	0.92	0.92	0.92	0.92	0.92	0.92	1	S2
S3	0	0	0.46	0.46	0.46	0.46	0.46	0.46	0.92	0.92	0.92	0.92	0.92	1	S3
S4	0	0.46	0	0.46	0.46	0.46	0.46	0.46	0.46	0.92	0.92	0.92	0.92	1	S4
S5	0	0	0	0	0.46	0.46	0.46	0.46	0.46	0.46	0.92	0.92	0.92	1	S5
S6	0	0	0	0	0	0.46	0.46	0.46	0.46	0.46	0.46	0.92	0.92	1	S6
S7	0	0	0	0	0	0	0.46	0.46	0.46	0.46	0.46	0.46	0.92	1	S7

Load Chart of HC Configuration

Load chart - HC Configuration (Double hooks, using aux. hook)															
Rear counterweight 0t, Carbody counterweight 20t, Gauge 7.35m, Ground level 0.57°															
Radius (m)	Boom length (m)														Radius (m)
	14.4	19.1	23.8	28.5	33.2	37.9	42.5	47.2	51.9	56.6	61.3	66.0	70.7	75.4	
3	10.5	10.5													3
3.5	10.5	10.5													3.5
4	10.5	10.5	10.5												4
4.5	10.5	10.5	10.5												4.5
5	10.5	10.5	10.5	10.5											5
5.5	10.5	10.5	10.5	10.5											5.5
6	10.5	10.5	10.5	10.5	10.5										6
7	10.5	10.5	10.5	10.5	10.5	10.5									7
8	10.5	10.5	10.5	10.5	10.5	10.5	10.5								8
9	10.5	10.5	10.5	10.5	10.5	10.5	10.5	10.5							9
10	10.5	10.5	10.5	10.5	10.5	10.5	10.5	10.5	10.5						10
11	10.5	10.5	10.5	10.5	10.5	10.5	10.5	10.5	10.5	10.5					11
12		10.5	10.5	10.5	10.5	10.5	10.5	10.5	10.5	10.5	10.5				12
13		10.5	10.5	10.5	10.5	10.5	10.5	10.5	10.5	10.5	10.5	10.5			13
14		10.5	10.5	10.5	10.5	10.5	10.5	10.5	10.5	10.5	10.5	10.5	10.5		14
16			10.5	10.5	10.5	10.5	10.5	10.2	9.2	8.8	8.6	8.6	8.7	8.3	16
18			8.9	8.5	9.4	8.6	9.2	7.8	7	6.6	6.5	6.6	6.8	6.4	18
20			6.6	6.3	7.2	6.4	7.1	5.8	5.1	4.8	4.8	5	5.2	4.9	20
22				4.5	5.4	4.6	5.4	4.2	3.5	3.3	3.4	3.6	3.8	3.6	22
24				3	3.9	3.2	4	2.8	2.2	2	2.1	2.4	2.7	2.4	24
26					2.7	2	2.7	1.6	1.1		1.1	1.3	1.7	1.5	26
28					1.7		1.7								28
30															30
32															32
34															34
36															36
n	1	1	1	1	1	1	1	1	1	1	1	1	1	1	n
S2	0	0	0.46	0.46	0.46	0.46	0.46	0.92	0.92	0.92	0.92	0.92	0.92	1	S2
S3	0	0	0.46	0.46	0.46	0.46	0.46	0.46	0.92	0.92	0.92	0.92	0.92	1	S3
S4	0	0.46	0	0.46	0.46	0.46	0.46	0.46	0.46	0.92	0.92	0.92	0.92	1	S4
S5	0	0	0	0	0.46	0.46	0.46	0.46	0.46	0.46	0.92	0.92	0.92	1	S5
S6	0	0	0	0	0	0.46	0.46	0.46	0.46	0.46	0.46	0.92	0.92	1	S6
S7	0	0	0	0	0	0	0.46	0.46	0.46	0.46	0.46	0.46	0.92	1	S7

Working range of FJ

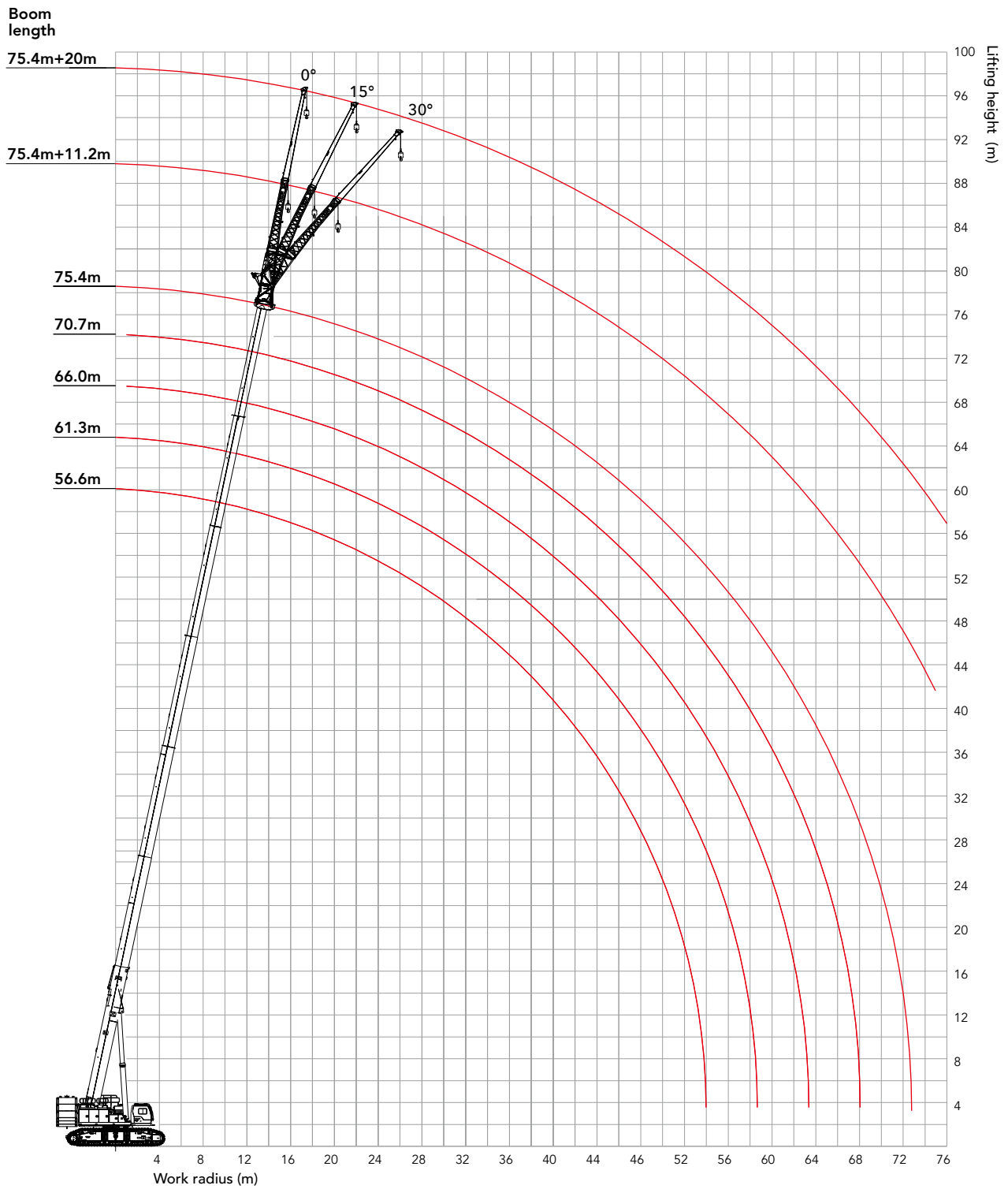

Working range of FJ

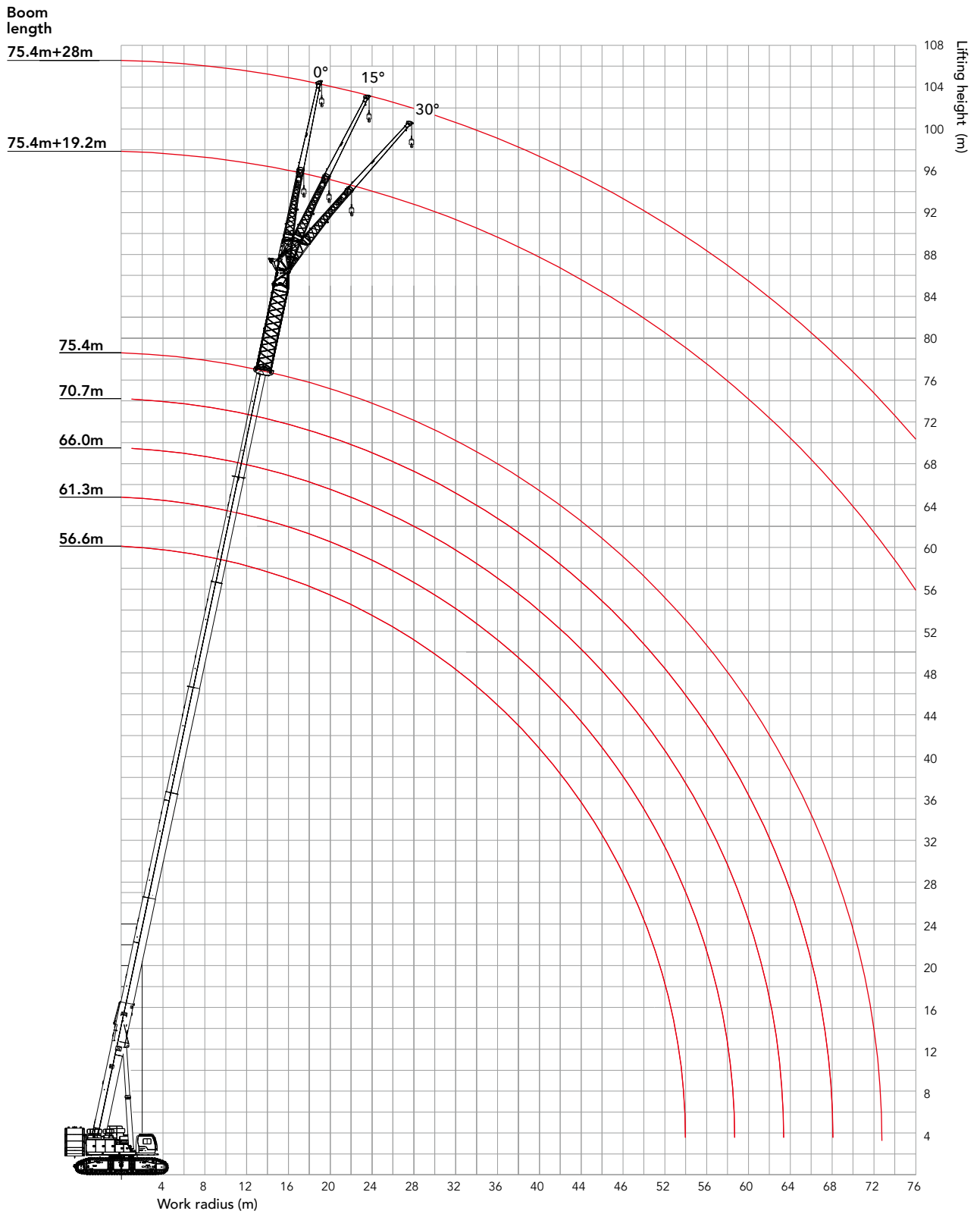

Working range of FJ

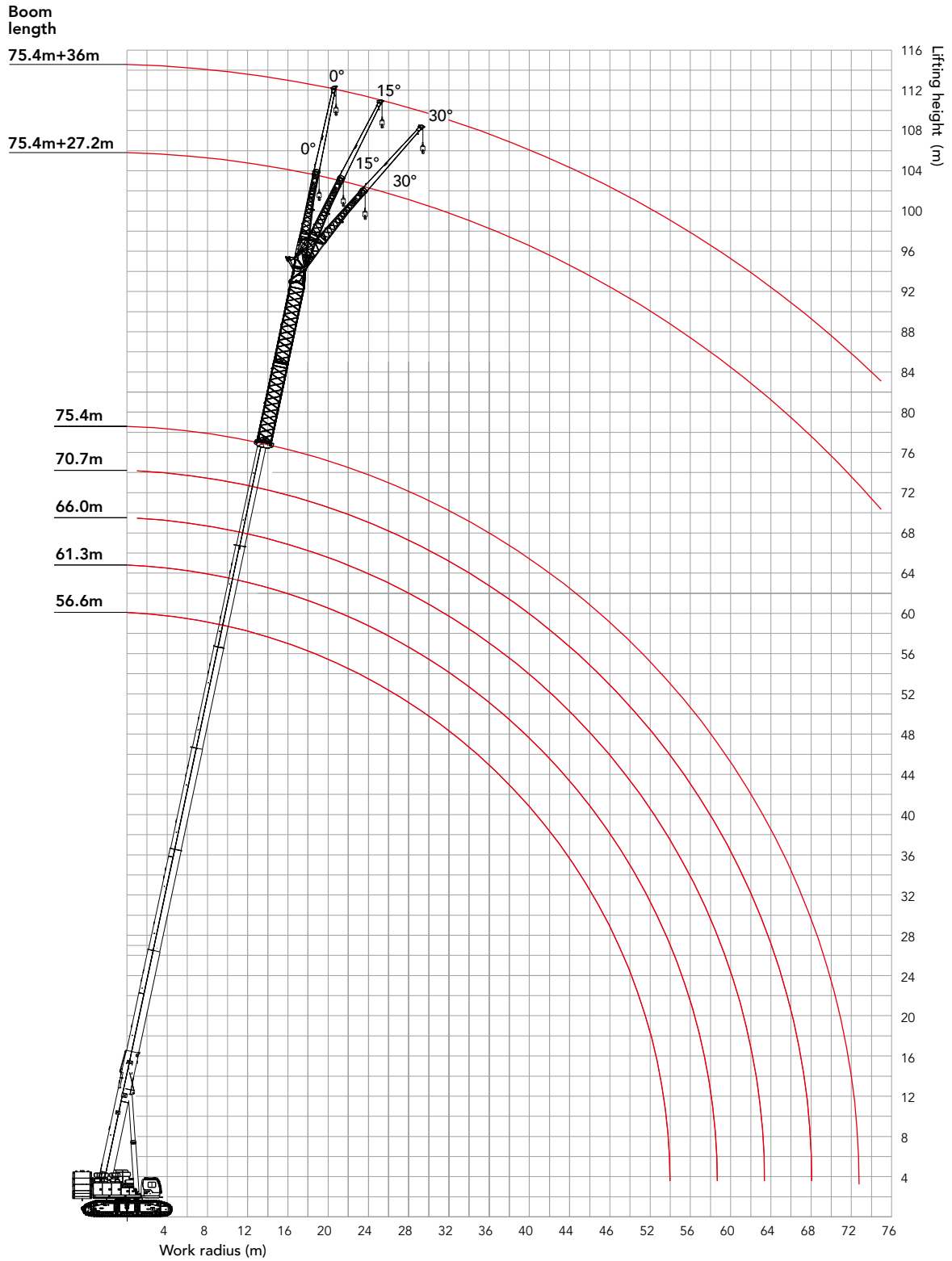

Working range of FJ

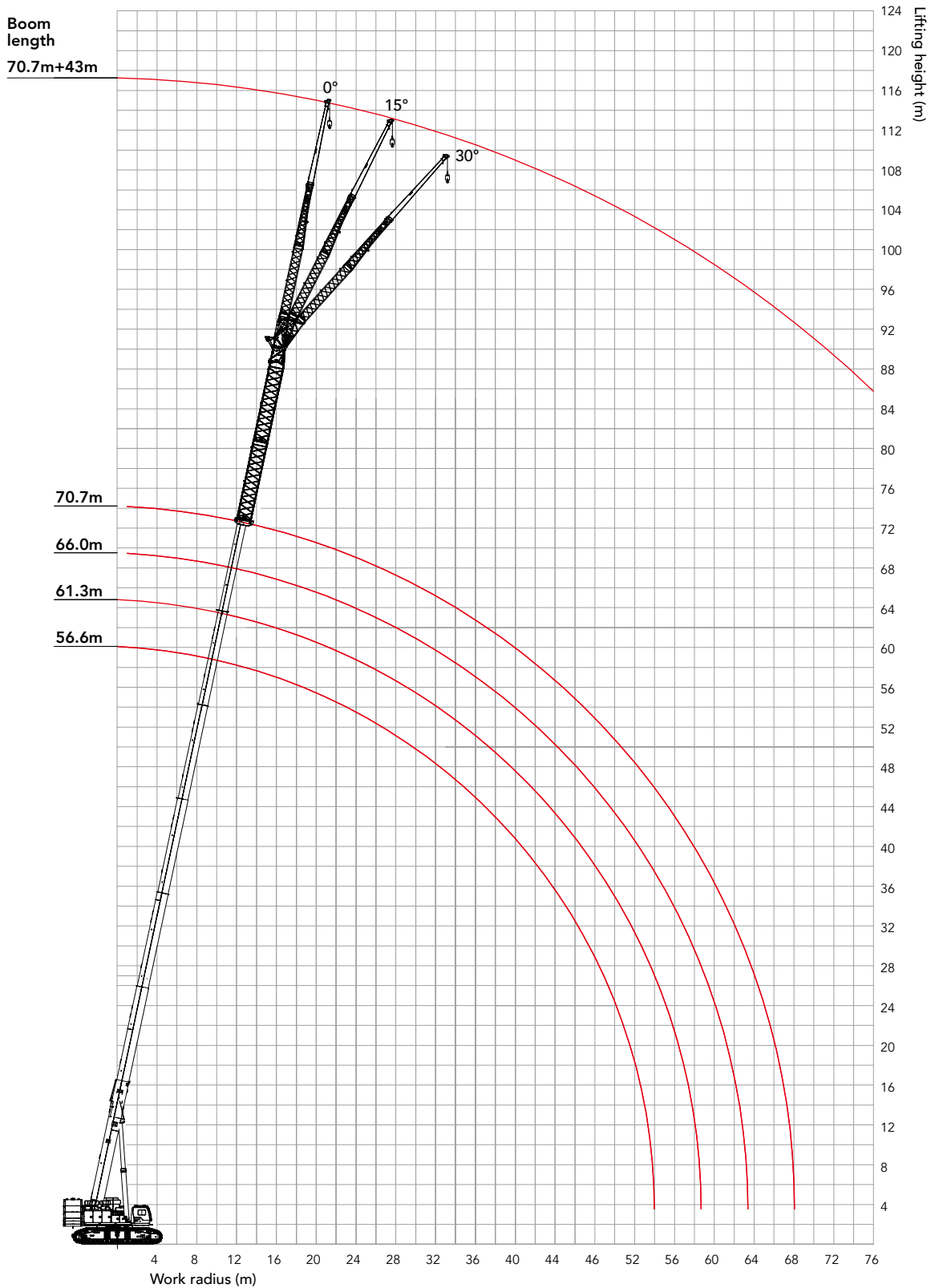

Load Chart of FJ Configuration

Load chart - FJ Configuration																
Rear counterweight 60t, Carbody counterweight 20t, Gauge 7.35m, Ground level 0.57°, Without main hook																
Boom (m)	56.6			61.3			66.0			70.7			75.4			Boom (m)
Jib (m)	20.0			20.0			20.0			20.0			20.0			Jib (m)
R	0°	15°	30°	0°	15°	30°	0°	15°	30°	0°	15°	30°	0°	15°	30°	R
16	5.4															16
18	5.3			4.8			4.3									18
20	5.1	4.5		4.7			4.2			3.7			3.2			20
22	5	4.3		4.5	4.3		4.1	4.2		3.7			3.3			22
24	4.8	4.4	2.5	4.4	4.2		4	4.1		3.6	3.7		3.3			24
26	4.6	4.3	2.5	4.3	4	2.5	4	3.8	2.6	3.6	3.7		3.3	3.3		26
28	4.4	4	2.3	4.1	3.8	2.4	3.9	3.7	2.5	3.6	3.6	2.5	3.3	3.3	2.6	28
30	4.2	3.9	2.3	4	3.7	2.3	3.7	3.7	2.4	3.5	3.5	2.5	3.3	3.3	2.5	30
32	4.1	3.7	2.2	3.9	3.6	2.3	3.7	3.6	2.3	3.5	3.4	2.4	3.3	3.2	2.4	32
34	3.9	3.5	2.2	3.7	3.5	2.2	3.6	3.4	2.3	3.4	3.3	2.3	3.3	3.2	2.4	34
36	3.7	3.3	2.1	3.6	3.3	2.2	3.5	3.3	2.3	3.4	3.2	2.3	3.2	3.2	2.4	36
38	3.6	3.2	2.1	3.5	3	2.2	3.4	3.2	2.2	3.3	3.2	2.2	3.1	3.1	2.3	38
40	3.4	3.1	2.1	3.4	3.1	2.1	3.4	3.1	2.1	3.2	3	2.2	3	3	2.2	40
42	3.3	2.9	2	3.3	2.9	2.1	3.2	2.9	2.1	3.1	3	2.2	2.9	3	2.2	42
44	3.1	2.8	1.9	3.1	2.8	2	3.1	2.8	2.1	3	2.8	2.1	2.9	2.9	2.1	44
46	3	2.7	1.9	3	2.7	2	3	2.7	2	2.9	2.8	2.1	2.8	2.8	2.1	46
48	2.9	2.5	1.9	2.9	2.6	1.9	3	2.6	2	2.8	2.7	2	2.7	2.7	2.1	48
50	2.7	2.4	1.9	2.8	2.5	1.9	2.8	2.5	2	2.7	2.6	2	2.6	2.7	2.1	50
52	2.7	2.3	1.8	2.7	2.4	1.9	2.7	2.4	2	2.6	2.5	2	2.5	2.6	2.1	52
54	2.6	2.2	1.8	2.6	2.3	1.9	2.7	2.3	1.9	2.5	2.4	1.9	2.4	2.5	2	54
56	2.5	2.2	1.8	2.5	2.2	1.9	2.6	2.2	1.9	2.5	2.3	1.9	2.3	2.4	2	56
58	2.4	2.1	1.8	2.5	2.1	1.9	2.6	2.2	1.9	2.4	2.2	1.9	2.2	2.3	2	58
60	2.3	2	1.8	2.4	2.1	1.8	2.5	2.1	1.9	2.3	2.1	1.9	2	2.1	2	60
62	2.2	1.9		2.3	2	1.8	2.4	2	1.9	2.2	2	1.9	1.9	2	2	62
64	2.2	1.9		2.2	1.9	1.8	2.3	2	1.8	2	1.9	1.9	1.7	1.8	1.9	64
66	2.2	1.8		2.2	1.9	1.8	2.2	1.9	1.8	1.9	1.8	1.8	1.6	1.7	1.8	66
68	1.9	1.8		1.9	1.8		2	1.8	1.7	1.8	1.7	1.7	1.4	1.5	1.6	68
70	1.6			1.6	1.7		1.8	1.7		1.6	1.6	1.6	1.3	1.4	1.5	70
72	1.4			1.4	1.6		1.5	1.7		1.5	1.5	1.6	1.2	1.3	1.3	72
74				1.1			1.3	1.5		1.3	1.3	1.4	1	1.1	1.2	74
76							1	1.2		1.2	1.2		0.9	1	1.1	76
78							0.8	1		1	1.1					78
80							0.6			0.8	1					80
82										0.6	0.7					82
n	1			1			1			1			1			n
S2	0.92			0.92			0.92			0.92			1.00			S2
S3	0.92			0.92			0.92			0.92			1.00			S3
S4	0.92			0.92			0.92			0.92			1.00			S4
S5	0.46			0.92			0.92			0.92			1.00			S5
S6	0.46			0.46			0.92			0.92			1.00			S6
S7	0.46			0.46			0.46			0.92			1.00			S7

Load Chart of FJ Configuration

Load chart - FJ Configuration																
Rear counterweight 60t, Carbody counterweight 20t, Gauge 7.35m, Ground level 0.57°, Without main hook																
Boom (m)	56.6			61.3			66.0			70.7			75.4			Boom (m)
Jib (m)	19.2			19.2			19.2			19.2			19.2			Jib (m)
R	0°	15°	30°	0°	15°	30°	0°	15°	30°	0°	15°	30°	0°	15°	30°	R
16	9.9															16
18	9.6	7.5		7.7			5.7									18
20	9.4	6.8	4.4	7.5	7.1		5.7	5.6		4.7			3.7			20
22	9.1	6.4	4.2	7.4	7.0	4.2	5.6	5.6	4.4	4.6	4.7		3.6	3.8		22
24	8.8	6.1	4.1	7.2	6.8	4.1	5.6	5.5	4.2	4.6	4.6	4.1	3.6	3.7	3.8	24
26	8.5	5.6	3.9	6.9	6.6	4.0	5.4	5.4	3.8	4.5	4.5	3.9	3.6	3.6	3.7	26
28	8.3	5.2	3.7	6.8	6.4	3.8	5.3	5.2	3.6	4.4	4.3	3.7	3.5	3.5	3.6	28
30	8.0	5.1	3.6	6.6	6.1	3.7	5.1	5.0	3.6	4.3	4.2	3.7	3.4	3.5	3.5	30
32	7.7	4.6	3.5	6.3	5.9	3.6	4.9	4.8	3.6	4.1	4.1	3.7	3.3	3.4	3.4	32
34	7.5	4.5	3.3	6.1	5.7	3.5	4.8	4.7	3.5	4.0	4.0	3.5	3.3	3.3	3.3	34
36	7.1	4.3	3.1	5.8	5.5	3.4	4.5	4.5	3.3	3.9	3.9	3.3	3.2	3.2	3.2	36
38	6.8	4.1	3.1	5.6	5.3	3.2	4.4	4.4	3.2	3.7	3.7	3.3	3.0	3.1	3.2	38
40	6.2	4.0	3.1	5.3	5.2	3.2	4.3	4.2	3.1	3.6	3.6	3.3	2.9	3.0	3.1	40
42	5.8	3.8	2.9	5.0	5.0	2.9	4.1	4.1	3.1	3.5	3.5	3.2	2.9	2.9	3.0	42
44	5.4	3.6	2.7	4.7	4.7	2.9	4.0	3.9	3.1	3.4	3.4	3.0	2.8	2.8	2.9	44
46	5.0	3.5	2.7	4.4	4.5	2.9	3.9	3.9	2.9	3.3	3.3	2.9	2.8	2.7	2.8	46
48	4.6	3.4	2.5	4.2	4.3	2.8	3.7	3.7	2.7	3.2	3.2	2.9	2.6	2.7	2.7	48
50	4.3	3.3	2.7	4.0	4.0	2.6	3.6	3.7	2.7	3.0	3.1	2.9	2.5	2.6	2.6	50
52	3.9	3.1	2.6	3.7	3.8	2.6	3.5	3.6	2.5	2.9	3.1	2.9	2.4	2.5	2.5	52
54	3.5	3.0	2.4	3.4	3.5	2.7	3.3	3.4	2.7	2.8	2.9	2.8	2.3	2.3	2.4	54
56	3.1	3.0	2.5	3.1	3.3	2.6	3.1	3.3	2.6	2.6	2.7	2.5	2.1	2.2	2.3	56
58	2.8	2.9	2.4	2.9	3.0	2.4	3.0	3.0	2.4	2.5	2.6	2.5	2.0	2.1	2.2	58
60	2.6	2.7	2.4	2.7	2.8	2.4	2.8	2.9	2.5	2.3	2.4	2.4	1.8	1.9	2.0	60
62	2.5	2.5		2.5	2.6	2.4	2.5	2.7	2.4	2.1	2.3	2.3	1.6	1.8	1.9	62
64	2.2	2.4		2.2	2.4		2.2	2.4	2.4	1.9	2.0	2.1	1.5	1.6	1.7	64
66	1.9	2.1		2.0	2.2		2.1	2.2	2.2	1.7	1.8	1.8	1.3	1.4	1.5	66
68	1.8	1.9		1.8	2.0		2.0	2.1		1.6	1.7	1.7	1.2	1.3	1.3	68
70	1.5			1.6	1.8		1.7	1.9		1.5	1.6	1.6	1.1	1.2	1.3	70
72	1.3			1.3	1.5		1.4	1.6		1.3	1.4		0.9	1.0	1.1	72
74				1.1			1.2	1.4		1.1	1.2			0.9	0.9	74
76							1.0	1.1		0.9	1.0					76
78							0.8			0.8	0.9					78
80																80
n	1			1			1			1			1			n
S2	0.92			0.92			0.92			0.92			1.00			S2
S3	0.92			0.92			0.92			0.92			1.00			S3
S4	0.92			0.92			0.92			0.92			1.00			S4
S5	0.46			0.92			0.92			0.92			1.00			S5
S6	0.46			0.46			0.92			0.92			1.00			S6
S7	0.46			0.46			0.46			0.92			1.00			S7

Load Chart of FJ Configuration

Load chart - FJ Configuration																
Rear counterweight 60t, Carbody counterweight 20t, Gauge 7.35m, Ground level 0.57°, Without main hook																
Boom (m)	56.6			61.3			66.0			70.7			75.4			Boom (m)
Jib (m)	28.0			28.0			28.0			28.0			28.0			Jib (m)
R	0°	15°	30°	0°	15°	30°	0°	15°	30°	0°	15°	30°	0°	15°	30°	R
18	4.4															18
20	4.3			3.9			3.4									20
22	4.2	4.0		3.9			3.4			2.9			2.3			22
24	4.2	3.8		3.8	3.6		3.4	3.4		2.9			2.3			24
26	4.0	3.7	3.3	3.7	3.5		3.4	3.3		2.9	3.0		2.3			26
28	4.0	3.6	3.2	3.7	3.5	3.1	3.4	3.4	3.1	2.9	2.9		2.3	2.5		28
30	3.8	3.4	3.1	3.6	3.4	3.1	3.4	3.3	3.1	2.9	2.9		2.3	2.4		30
32	3.8	3.3	3.0	3.5	3.2	3.0	3.3	3.2	3.0	2.8	2.8	2.7	2.3	2.4		32
34	3.6	3.2	2.9	3.5	3.2	2.9	3.3	3.2	3.0	2.8	2.8	2.7	2.3	2.5	2.4	34
36	3.5	3.1	2.7	3.4	3.1	2.8	3.3	3.1	2.9	2.8	2.8	2.7	2.3	2.5	2.4	36
38	3.5	3.0	2.7	3.3	3.1	2.8	3.2	3.1	2.9	2.8	2.8	2.7	2.3	2.4	2.4	38
40	3.4	2.9	2.6	3.3	3.0	2.7	3.2	3.1	2.8	2.8	2.7	2.6	2.3	2.4	2.4	40
42	3.3	2.8	2.5	3.2	2.9	2.7	3.2	3.1	2.8	2.8	2.7	2.6	2.3	2.3	2.3	42
44	3.2	2.7	2.4	3.1	2.8	2.6	3.1	3.0	2.8	2.7	2.6	2.6	2.3	2.2	2.3	44
46	3.1	2.6	2.4	3.1	2.8	2.6	3.0	3.0	2.8	2.6	2.6	2.5	2.2	2.2	2.2	46
48	3.0	2.5	2.3	3.0	2.7	2.6	3.0	2.9	2.8	2.6	2.5	2.5	2.2	2.1	2.1	48
50	3.0	2.5	2.2	2.9	2.7	2.5	2.9	2.9	2.8	2.5	2.5	2.5	2.1	2.1	2.1	50
52	2.8	2.4	2.2	2.8	2.6	2.5	2.8	2.8	2.8	2.4	2.4	2.4	1.9	2.0	2.0	52
54	2.7	2.3	2.1	2.7	2.5	2.4	2.7	2.8	2.7	2.3	2.4	2.3	1.8	2.0	1.9	54
56	2.7	2.3	2.0	2.7	2.5	2.4	2.7	2.7	2.7	2.2	2.3	2.3	1.7	1.9	1.9	56
58	2.6	2.2	2.0	2.6	2.4	2.3	2.6	2.7	2.6	2.1	2.2	2.2	1.6	1.8	1.8	58
60	2.5	2.1	1.9	2.5	2.4	2.2	2.5	2.6	2.5	2.1	2.1	2.1	1.6	1.7	1.7	60
62	2.4	2.1	1.9	2.4	2.3	2.1	2.4	2.5	2.4	1.9	2.1	2.1	1.4	1.6	1.7	62
64	2.3	2.0	1.8	2.3	2.2	2.1	2.3	2.4	2.4	1.8	2.0	2.0	1.3	1.5	1.6	64
66	2.2	1.8	1.8	2.2	2.0	2.1	2.2	2.2	2.3	1.7	1.8	1.9	1.2	1.4	1.5	66
68	2.0	1.7	1.7	1.9	1.9	2.0	1.9	2.1	2.2	1.5	1.7	1.8	1.1	1.3	1.4	68
70	1.8	1.7		1.8	1.8	1.9	1.7	2.0	2.1	1.3	1.6	1.7	1.0	1.2	1.2	70
72	1.6	1.6		1.6	1.7	1.8	1.6	1.7	1.8	1.2	1.4	1.5	0.8	1.0	1.2	72
74	1.4	1.4		1.4	1.5		1.5	1.6	1.6	1.1	1.3	1.3		0.9	1.0	74
76	1.2	1.3		1.2	1.4		1.3	1.5	1.5		1.2	1.2			0.8	76
78	1.0			1.0	1.2		1.0	1.3				1.1				78
80	0.8			0.8	1.0		0.8	1.1								80
82				0.6			0.6	0.9								82
84				0.4				0.7								84
n	1			1			1			1			1			n
S2	0.92			0.92			0.92			0.92			1.00			S2
S3	0.92			0.92			0.92			0.92			1.00			S3
S4	0.92			0.92			0.92			0.92			1.00			S4
S5	0.46			0.92			0.92			0.92			1.00			S5
S6	0.46			0.46			0.92			0.92			1.00			S6
S7	0.46			0.46			0.46			0.92			1.00			S7

Load Chart of FJ Configuration

Load chart - FJ Configuration																
Rear counterweight 60t, Carbody counterweight 20t, Gauge 7.35m, Ground level 0.57°, Without main hook																
Boom (m)	56.6			61.3			66.0			70.7			75.4			Boom (m)
Jib (m)	27.2			27.2			27.2			27.2			27.2			Jib (m)
R	0°	15°	30°	0°	15°	30°	0°	15°	30°	0°	15°	30°	0°	15°	30°	R
18	6.5															18
20	6.2	5.9		5.3			4.5									20
22	6.0	5.8	4.5	5.2	5.0		4.4	4.3		3.5			2.7			22
24	5.9	5.6	4.1	5.1	4.9	4.1	4.3	4.2		3.5			2.7			24
26	5.6	5.3	3.9	4.9	4.7	4.0	4.2	4.1	4.0	3.4	3.4	3.4	2.6	2.6		26
28	5.4	5.1	4.0	4.7	4.6	3.8	4.1	4.0	4.0	3.4	3.3	3.3	2.6	2.6	2.6	28
30	5.2	5.0	3.8	4.6	4.4	3.6	4.0	3.9	3.9	3.3	3.2	3.2	2.6	2.5	2.5	30
32	5.0	4.8	3.8	4.5	4.3	3.6	3.9	3.8	3.8	3.2	3.1	3.2	2.5	2.5	2.5	32
34	4.9	4.6	3.6	4.3	4.2	3.6	3.8	3.7	3.6	3.1	3.1	3.1	2.4	2.5	2.5	34
36	4.7	4.4	3.2	4.2	4.0	3.4	3.7	3.6	3.5	3.1	3.0	3.0	2.3	2.4	2.4	36
38	4.5	4.3	3.2	4.0	3.9	3.2	3.5	3.5	3.5	2.9	2.9	3.0	2.3	2.3	2.4	38
40	4.4	4.1	3.2	3.9	3.7	3.2	3.4	3.4	3.4	2.9	2.8	2.9	2.2	2.3	2.3	40
42	4.2	4.0	3.1	3.8	3.6	3.2	3.3	3.3	3.2	2.8	2.7	2.8	2.1	2.2	2.2	42
44	4.1	3.9	2.9	3.6	3.5	3.1	3.2	3.2	3.0	2.7	2.7	2.7	2.1	2.1	2.1	44
46	4.0	3.7	3.0	3.5	3.4	2.9	3.1	3.1	3.0	2.6	2.6	2.6	2.0	2.1	2.1	46
48	3.8	3.6	3.0	3.4	3.2	3.0	3.0	2.9	3.1	2.5	2.5	2.6	2.0	2.1	2.1	48
50	3.7	3.5	2.7	3.3	3.2	2.7	2.9	2.8	2.9	2.4	2.4	2.4	2.0	2.0	2.0	50
52	3.6	3.4	2.7	3.2	3.1	2.7	2.8	2.7	2.7	2.3	2.3	2.3	1.9	1.9	1.9	52
54	3.5	3.3	2.7	3.1	3.0	2.7	2.7	2.6	2.7	2.3	2.2	2.3	1.8	1.8	1.9	54
56	3.3	3.2	2.7	3.0	2.9	2.7	2.6	2.5	2.6	2.2	2.1	2.2	1.7	1.7	1.8	56
58	3.2	3.2	2.6	2.9	2.8	2.6	2.5	2.4	2.4	2.1	2.0	2.2	1.6	1.6	1.7	58
60	3.1	3.1	2.5	2.7	2.7	2.5	2.4	2.3	2.5	1.9	1.9	2.1	1.4	1.5	1.6	60
62	2.8	2.8	2.6	2.5	2.6	2.6	2.2	2.3	2.4	1.8	1.9	1.9	1.4	1.4	1.5	62
64	2.5	2.5	2.5	2.3	2.4	2.4	2.1	2.2	2.2	1.7	1.8	1.8	1.3	1.4	1.4	64
66	2.3	2.3	2.4	2.1	2.2	2.3	1.9	2.0	2.1	1.5	1.6	1.7	1.1	1.2	1.3	66
68	2.1	2.3		1.9	2.0	2.1	1.6	1.8	1.9	1.3	1.5	1.5	1.0	1.1	1.2	68
70	1.8	2.0		1.7	1.8		1.5	1.6	1.6	1.1	1.3	1.3		0.9	1.0	70
72	1.5	1.8		1.5	1.7		1.5	1.5	1.5		1.1	1.1				72
74	1.3	1.5		1.3	1.5		1.3	1.4								74
76	1.1			1.1	1.3		1.1	1.2								76
78	0.9			0.8	1.1		0.9	1.1								78
80				0.6	0.8		0.7	0.9								80
82																82
n	1			1			1			1			1			n
S2	0.92			0.92			0.92			0.92			1.00			S2
S3	0.92			0.92			0.92			0.92			1.00			S3
S4	0.92			0.92			0.92			0.92			1.00			S4
S5	0.46			0.92			0.92			0.92			1.00			S5
S6	0.46			0.46			0.92			0.92			1.00			S6
S7	0.46			0.46			0.46			0.92			1.00			S7

Load Chart of FJ Configuration

Load chart - FJ Configuration																
Rear counterweight 60t, Carbody counterweight 20t, Gauge 7.35m, Ground level 0.57°, Without main hook																
Boom (m)	56.6			60.8			66.0			70.7			75.4			Boom (m)
Jib (m)	36.0			36.0			36.0			36.0			36.0			Jib (m)
R	0°	15°	30°	0°	15°	30°	0°	15°	30°	0°	15°	30°	0°	15°	30°	R
20	3.4															20
22	3.4			3.1			2.7									22
24	3.3	3.4		3.0			2.7			2.1			1.5			24
26	3.2	3.3		3.0	3.0		2.7	2.6		2.1			1.5			26
28	3.2	3.3	3.1	2.9	2.9		2.7	2.6		2.1	2.2		1.5	1.8		28
30	3.1	3.2	3.0	2.8	2.9	2.8	2.6	2.6		2.1	2.2		1.5	1.8		30
32	3.0	3.0	3.0	2.8	2.8	2.8	2.6	2.5	2.5	2.1	2.2		1.5	1.8		32
34	3.0	2.9	2.9	2.8	2.7	2.7	2.6	2.5	2.5	2.0	2.2	2.1	1.5	1.8		34
36	2.9	2.9	2.7	2.7	2.7	2.7	2.6	2.5	2.5	2.1	2.1	2.1	1.5	1.8	1.8	36
38	2.8	2.8	2.7	2.7	2.6	2.7	2.5	2.4	2.4	2.0	2.1	2.1	1.5	1.8	1.8	38
40	2.8	2.7	2.6	2.6	2.6	2.6	2.5	2.4	2.3	2.0	2.1	2.0	1.5	1.7	1.7	40
42	2.7	2.6	2.6	2.6	2.5	2.5	2.5	2.4	2.3	2.0	2.1	2.0	1.5	1.8	1.7	42
44	2.6	2.5	2.6	2.5	2.4	2.4	2.4	2.3	2.3	2.0	2.0	2.0	1.5	1.7	1.7	44
46	2.5	2.5	2.5	2.5	2.4	2.4	2.4	2.3	2.3	2.0	1.9	2.0	1.5	1.6	1.7	46
48	2.5	2.4	2.4	2.4	2.3	2.3	2.3	2.2	2.2	1.9	1.9	1.9	1.5	1.6	1.6	48
50	2.4	2.3	2.4	2.3	2.3	2.3	2.3	2.2	2.1	1.9	1.9	1.9	1.5	1.5	1.6	50
52	2.3	2.3	2.3	2.3	2.2	2.2	2.3	2.2	2.2	1.9	1.8	1.8	1.5	1.5	1.5	52
54	2.3	2.2	2.2	2.2	2.2	2.1	2.2	2.1	2.1	1.8	1.8	1.8	1.4	1.4	1.5	54
56	2.2	2.1	2.2	2.2	2.1	2.1	2.1	2.1	2.1	1.7	1.8	1.8	1.4	1.4	1.4	56
58	2.2	2.0	2.1	2.1	2.0	2.1	2.1	2.0	2.0	1.7	1.7	1.7	1.3	1.3	1.4	58
60	2.1	2.0	2.0	2.1	2.0	2.0	2.1	2.0	2.0	1.6	1.7	1.7	1.2	1.4	1.3	60
62	2.0	2.0	2.0	2.0	2.0	2.0	2.0	2.0	2.0	1.5	1.6	1.7	1.1	1.3	1.4	62
64	2.0	1.9	1.9	1.9	1.9	1.9	1.9	1.9	1.9	1.4	1.5	1.6	1.0	1.2	1.2	64
66	2.0	1.9	1.9	1.9	1.8	1.9	1.8	1.7	1.9	1.3	1.4	1.5	0.9	1.1	1.1	66
68	1.8	1.8	1.9	1.8	1.8	1.8	1.7	1.7	1.8		1.3	1.4		1.0	1.0	68
70	1.7	1.8	1.8	1.7	1.7	1.7	1.6	1.6	1.6		1.3	1.3			0.9	70
72	1.6	1.7	1.7	1.5	1.6	1.6	1.4	1.5	1.6							72
74	1.4	1.6	1.6	1.3	1.5	1.5	1.2	1.4	1.5							74
76	1.2	1.4	1.5	1.2	1.3	1.4	1.1	1.2	1.4							76
78	1.1	1.2		1.1	1.1	1.2	1.1	1.0	1.1							78
80	0.9	1.0		0.9	1.0		1.0	0.9	1.0							80
82	0.8	0.9			0.9		0.8	0.9	0.9							82
84	0.6	0.8						0.7								84
86	0.4	0.6														86
n	1			1			1			1			1			n
S2	0.92			0.92			0.92			0.92			1.00			S2
S3	0.92			0.92			0.92			0.92			1.00			S3
S4	0.92			0.92			0.92			0.92			1.00			S4
S5	0.46			0.92			0.92			0.92			1.00			S5
S6	0.46			0.46			0.92			0.92			1.00			S6
S7	0.46			0.46			0.46			0.92			1.00			S7

Load Chart of FJ Configuration

Load chart - FJ Configuration													
Rear counterweight 60t, Carbody counterweight 20t, Gauge 7.35m, Ground level 0.57°, Without main hook													
Boom (m)	56.6			61.3			66.0			70.7			Boom (m)
Jib (m)	43.0			43.0			43.0			43.0			Jib (m)
R	0°	15°	30°	0°	15°	30°	0°	15°	30°	0°	15°	30°	R
22	2.4			2.1									22
24	2.4			2.1			1.7			1.4			24
26	2.5			2.1			1.7			1.4			26
28	2.5	2.3		2.1	2.0		1.7			1.4			28
30	2.4	2.4		2.1	2.0		1.7	1.7		1.4			30
32	2.4	2.4	2.1	2.1	2.0		1.7	1.7		1.4	1.4		32
34	2.4	2.4	2.1	2.1	2.0	1.8	1.7	1.7		1.4	1.4		34
36	2.4	2.3	2.1	2.1	2.0	1.8	1.7	1.7	1.5	1.4	1.4	1.2	36
38	2.4	2.3	2.1	2.0	2.0	1.8	1.7	1.7	1.5	1.4	1.4	1.3	38
40	2.3	2.3	2.1	2.0	2.0	1.8	1.7	1.7	1.6	1.4	1.4	1.3	40
42	2.2	2.2	2.1	1.9	1.9	1.8	1.7	1.7	1.6	1.4	1.4	1.3	42
44	2.2	2.2	2.1	1.9	1.9	1.8	1.6	1.6	1.5	1.4	1.4	1.3	44
46	2.1	2.1	2.1	1.9	1.8	1.8	1.6	1.6	1.5	1.4	1.4	1.3	46
48	2.1	2.1	2.1	1.8	1.8	1.8	1.6	1.6	1.5	1.3	1.3	1.3	48
50	2.0	2.0	2.0	1.8	1.8	1.8	1.6	1.6	1.5	1.4	1.3	1.3	50
52	2.0	2.0	2.0	1.7	1.7	1.7	1.5	1.5	1.5	1.3	1.3	1.2	52
54	1.9	1.9	1.9	1.7	1.7	1.7	1.5	1.5	1.5	1.3	1.3	1.3	54
56	1.9	1.9	1.9	1.7	1.7	1.7	1.4	1.4	1.4	1.2	1.2	1.2	56
58	1.8	1.8	1.8	1.6	1.6	1.6	1.4	1.4	1.4	1.2	1.2	1.2	58
60	1.7	1.7	1.7	1.5	1.5	1.5	1.3	1.3	1.3	1.1	1.1	1.1	60
62	1.7	1.7	1.7	1.5	1.5	1.5	1.3	1.3	1.3	1.1	1.1	1.1	62
64	1.6	1.6	1.6	1.4	1.4	1.4	1.2	1.2	1.2	1.0	1.0	1.0	64
66	1.5	1.5	1.5	1.3	1.3	1.3	1.1	1.1	1.1	0.9	1.0	1.0	66
68	1.4	1.4	1.4	1.3	1.3	1.3	1.1	1.1	1.1		0.9	1.0	68
70	1.3	1.3	1.3	1.2	1.2	1.2	1.0	1.0	1.0			0.9	70
72	1.3	1.3	1.3	1.2	1.2	1.2	1.0	1.0	1.0				72
74	1.2	1.2	1.2	1.1	1.1	1.1	0.9	0.9	1.0				74
76	1.1	1.1	1.1	1.0	1.0	1.0		0.8	0.9				76
78	1.0	1.0	1.0	0.9	0.9	0.9		0.8	0.8				78
80	1.0	1.0	1.0		0.8	0.8			0.7				80
82		1.0											82
84													84
86													86
88													88
n	1			1			1			1			n
S2	0.92			0.92			0.92			0.92			S2
S3	0.92			0.92			0.92			0.92			S3
S4	0.92			0.92			0.92			0.92			S4
S5	0.46			0.92			0.92			0.92			S5
S6	0.46			0.46			0.92			0.92			S6
S7	0.46			0.46			0.46			0.92			S7

Working range of FJh

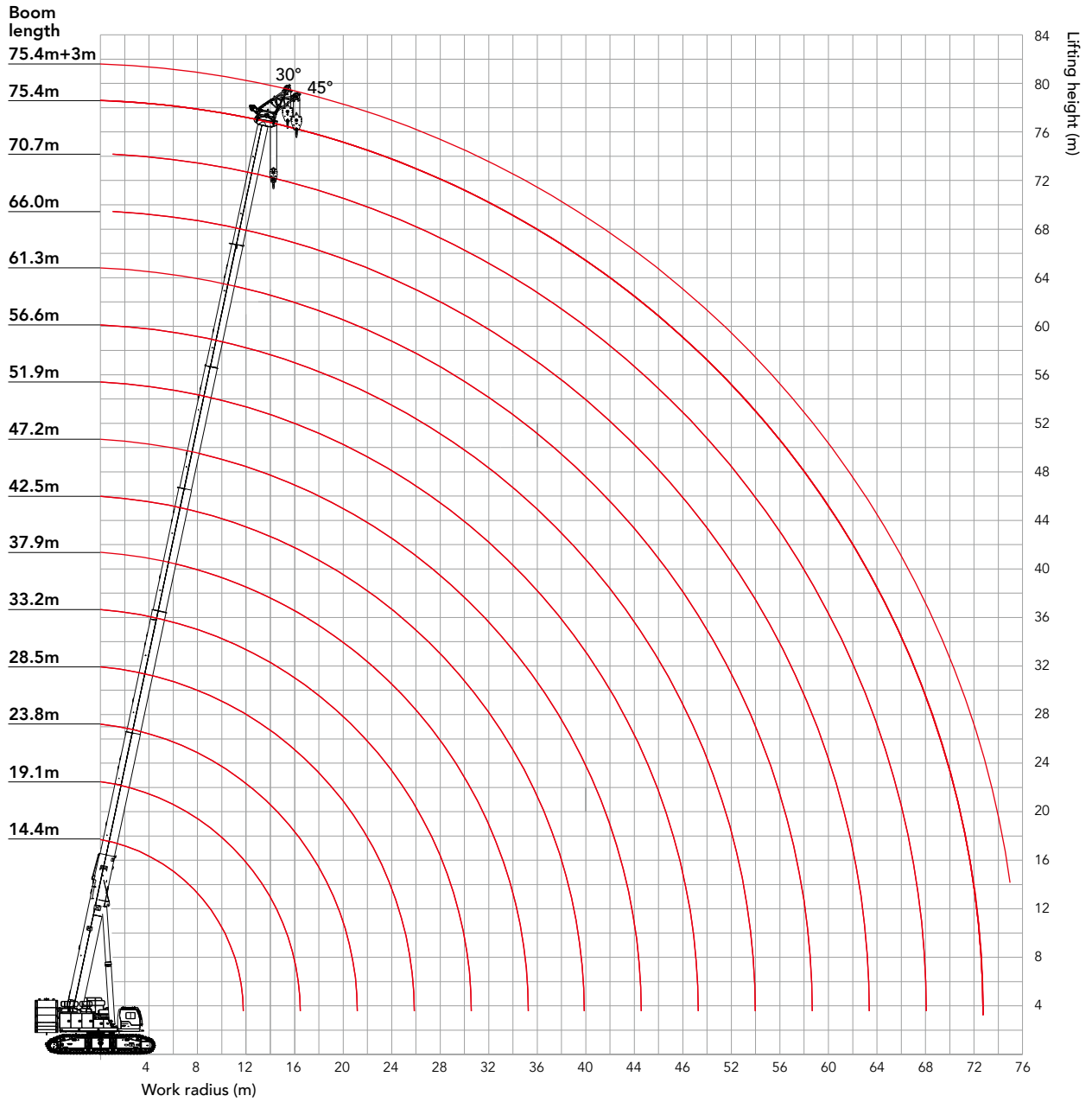

Load Chart of FJh Configuration

Load chart - FJh Configuration (double hooks, using main hook)															
Rear counterweight 60t, Carbody counterweight 20t, Gauge 7.35m, Ground level 0.57°, Boom to jib angle 30°, with fixed jib															
Radius (m)	Boom length (m)														Radius (m)
	14.4	19.1	23.8	28.5	33.2	37.9	42.5	47.2	51.9	56.6	61.3	66.0	70.7	75.4	
3	124	124.5													3
3.5	124.1	124.5	124.4												3.5
4	124.1	124.5	124.4												4
4.5	124.1	124.5	124.4	124.4											4.5
5	124.1	124.5	124.4	124.4											5
5.5	124.2	124.5	124.4	124.4	97.8										5.5
6	124.2	123.4	124.4	124.4	97.8										6
7	118.1	112.4	118.5	114.7	94.3	69.3									7
8	101.4	101.7	102.2	98.5	87.7	69.1	46.1								8
9	88	88.4	89.1	86.1	82	65.2	44.2	41.2							9
10	73.6	74.2	75	74.1	73.2	61.8	42.4	41.2	33.6						10
11		63.5	64.4	63.6	64.4	58.7	40.1	40.7	33.6	27.4					11
12		55.2	56.2	55.5	56.3	55	38.1	38.6	33.6	27.4	22.1				12
13		48.6	49.6	49	49.8	48.6	36.3	36.5	32.6	27.4	22.1				13
14		43.1	44.2	43.6	44.5	43.4	34.6	34.5	30.7	27.2	22.1	17.7			14
16			35.8	35.4	36.3	35.3	31.7	31.1	27.4	24.2	21.9	17.7	14.1	11.3	16
18			29.7	29.4	30.2	29.3	29.2	28.2	24.7	21.7	19.6	17.7	14.1	9.9	18
20				24.7	25.6	24.8	25.6	24.9	22.3	19.5	17.6	16.3	13.3	8.7	20
22				21.1	22	21.1	22	21.3	20.3	17.7	15.9	14.7	12.5	7.6	22
24					19	18.2	19	18.4	18.1	16.1	14.4	13.3	11.8	6.7	24
26					16.5	15.8	16.6	15.9	15.7	14.6	13.1	12	11.1	5.9	26
28						13.7	14.5	13.9	13.7	13.4	11.9	11	10.3	5.2	28
30						12	12.8	12.2	12	12	10.9	10	9.4	4.5	30
32							11.3	10.7	10.5	10.6	9.9	9.1	8.6	3.9	32
34							10	9.4	9.2	9.3	9.1	8.3	7.8	3.3	34
36								8.2	8.1	8.1	8.3	7.6	7.2	2.8	36
38								7.2	7	7.1	7.4	6.9	6.5	2.4	38
40									6.1	6.2	6.5	6.3	6	2	40
42									5.3	5.4	5.7	5.8	5.5	1.6	42
44										4.7	4.9	5.3	5	1.2	44
46										4	4.3	4.6	4.5		46
48											3.7	4	4.1		48
50											3.1	3.5	3.7		50
52												3	3.3		52
54												2.5	2.9		54
56													2.5		56
58													2.1		58
n	12	12	12	12	10	7	5	4	4	3	3	2	2	2	n
S2	0	0	0.46	0.46	0.46	0.46	0.46	0.92	0.92	0.92	0.92	0.92	0.92	1	S2
S3	0	0	0.46	0.46	0.46	0.46	0.46	0.46	0.92	0.92	0.92	0.92	0.92	1	S3
S4	0	0.46	0	0.46	0.46	0.46	0.46	0.46	0.46	0.92	0.92	0.92	0.92	1	S4
S5	0	0	0	0	0.46	0.46	0.46	0.46	0.46	0.46	0.92	0.92	0.92	1	S5
S6	0	0	0	0	0	0.46	0.46	0.46	0.46	0.46	0.46	0.92	0.92	1	S6
S7	0	0	0	0	0	0	0.46	0.46	0.46	0.46	0.46	0.46	0.92	1	S7

Load Chart of FJh Configuration

Load chart - FJh Configuration (double hooks, using main hook)															
Rear counterweight 60t, Carbody counterweight 20t, Gauge 7.35m, Ground level 0.57°, Boom to jib angle 45°, with fixed jib															
Radius (m)	Boom length (m)														Radius (m)
	14.4	19.1	23.8	28.5	33.2	37.9	42.5	47.2	51.9	56.6	61.3	66.02	70.7	75.4	
3	124	124.5													3
3.5	124.1	124.5	124.4												3.5
4	124.1	124.5	124.4												4
4.5	124.1	124.5	124.4	124.4											4.5
5	124.1	124.5	124.4	124.4											5
5.5	124.2	124.5	124.4	124.4	97.8										5.5
6	124.2	123.4	124.4	124.4	97.8										6
7	118.1	112.4	118.5	114.7	94.3	69.3									7
8	101.4	101.7	102.2	98.5	87.7	69.1	46.1								8
9		88.4	89.1	86.1	82	65.2	44.2	41.2							9
10		74.2	75	74.1	73.2	61.8	42.4	41.2	33.6						10
11		63.5	64.4	63.6	64.4	58.7	40.1	40.7	33.6	27.4					11
12			56.2	55.5	56.3	55	38.1	38.6	33.6	27.4	22.1				12
13			49.6	49	49.8	48.6	36.3	36.5	32.6	27.4	22.1				13
14			44.2	43.6	44.5	43.4	34.6	34.5	30.7	27.2	22.1	17.7			14
16				35.4	36.3	35.3	31.7	31.1	27.4	24.2	21.9	17.7	14.1	11.3	16
18				29.4	30.2	29.3	29.2	28.2	24.7	21.7	19.6	17.7	14.1	9.9	18
20					25.6	24.8	25.6	24.9	22.3	19.5	17.6	16.3	13.3	8.7	20
22						21.1	22	21.3	20.3	17.7	15.9	14.7	12.5	7.6	22
24						18.2	19	18.4	18.1	16.1	14.4	13.3	11.8	6.7	24
26							16.6	15.9	15.7	14.6	13.1	12	11.1	5.9	26
28							14.5	13.9	13.7	13.4	11.9	11	10.3	5.2	28
30								12.2	12	12	10.9	10	9.4	4.5	30
32									10.5	10.6	9.9	9.1	8.6	3.9	32
34									9.2	9.3	9.1	8.3	7.8	3.3	34
36										8.1	8.3	7.6	7.2	2.8	36
38										7.1	7.4	6.9	6.5	2.4	38
40											6.5	6.3	6	2	40
42												5.8	5.5	1.6	42
44												5.3	5	1.2	44
46													4.5		46
48													4.1		48
n	12	12	12	12	10	7	5	4	4	3	3	2	2	2	n
S2	0	0	0.46	0.46	0.46	0.46	0.46	0.92	0.92	0.92	0.92	0.92	0.92	1	S2
S3	0	0	0.46	0.46	0.46	0.46	0.46	0.46	0.92	0.92	0.92	0.92	0.92	1	S3
S4	0	0.46	0	0.46	0.46	0.46	0.46	0.46	0.46	0.92	0.92	0.92	0.92	1	S4
S5	0	0	0	0	0.46	0.46	0.46	0.46	0.46	0.46	0.92	0.92	0.92	1	S5
S6	0	0	0	0	0	0.46	0.46	0.46	0.46	0.46	0.46	0.92	0.92	1	S6
S7	0	0	0	0	0	0	0.46	0.46	0.46	0.46	0.46	0.46	0.92	1	S7

Load Chart of FJh Configuration

Load chart - FJh Configuration (double hooks, using aux. hook)

Rear counterweight 60t, Carbody counterweight 20t, Gauge 7.35m, Ground level 0.57°, with fixed jib

Radius (m)	Boom length (m)														Radius (m)
	14.4		19.1		23.8		28.5		33.2		37.9		42.5		
Off-set angle	30°	45°	30°	45°	30°	45°	30°	45°	30°	45°	30°	45°	30°	45°	Off-set angle
3															3
3.5															3.5
4															4
4.5	42.0	42.0	42.0	42.0											4.5
5	42.0	41.7	42.0	42.0											5
5.5	40.6	40.3	42.0	42.0	42.0	42.0									5.5
6	39.2	38.9	42.0	42.0	42.0	42.0									6
7	38.0	37.7	42.0	42.0	42.0	42.0	42.0	42.0							7
8	34.0	33.8	38.2	38.0	41.6	41.3	42.0	42.0	42.0	42.0					8
9	32.4	32.2	36.5	36.3	39.8	39.6	42.0	42.0	42.0	42.0	42.0	42.0			9
10	31.2	31.0	35.0	34.8	38.3	38.1	41.1	40.9	42.0	42.0	42.0	42.0	36.3	36.3	10
11	30.4	30.2	33.7	33.5	36.9	36.7	39.7	39.5	42.0	41.8	42.0	42.0	36.3	36.3	11
12	30.0	29.9	32.6	32.4	35.7	35.5	38.4	38.2	40.7	40.5	42.0	42.0	36.3	36.3	12
13			31.6	31.5	34.6	34.4	37.2	37.0	39.5	39.3	41.5	41.3	34.7	34.7	13
14			30.9	30.8	33.6	33.5	36.1	36.0	38.4	38.2	40.5	40.3	33.3	33.3	14
16			30.3		32.7	32.6	35.2	35.1	37.0	37.2	36.0	36.3	31.9	31.9	16
18					30.3	30.2	30.3	30.5	30.8	31.0	29.9	30.1	28.4	28.4	18
20					26.1		25.6	25.7	26.1	26.3	25.2	25.4	25.8	26.0	20
22							21.8	21.9	22.4	22.5	21.5	21.7	22.1	22.3	22
24							18.8		19.3	19.4	18.5	18.6	19.1	19.2	24
26									16.8		16.0	16.1	16.6	16.7	26
28									14.7		13.9	14.0	14.5	14.6	28
30											12.1		12.7	12.8	30
32											10.6		11.2	11.2	32
34													9.8		34
36													8.6		36
38													7.6		38
40															40
42															42
44															44
46															46
48															48
50															50
52															52
54															54
56															56
58															58
60															60
n	5	5	5	5	5	5	5	5	5	5	5	5	4	4	n
S2	0	0	0	0	0.46	0.46	0.46	0.46	0.46	0.46	0.46	0.46	0.46	0.46	S2
S3	0	0	0	0	0.46	0.46	0.46	0.46	0.46	0.46	0.46	0.46	0.46	0.46	S3
S4	0	0	0.46	0.46	0	0	0.46	0.46	0.46	0.46	0.46	0.46	0.46	0.46	S4
S5	0	0	0	0	0	0	0	0	0.46	0.46	0.46	0.46	0.46	0.46	S5
S6	0	0	0	0	0	0	0	0	0	0	0.46	0.46	0.46	0.46	S6
S7	0	0	0	0	0	0	0	0	0	0	0	0	0.46	0.46	S7

Load Chart of FJh Configuration

Load chart - FJh Configuration (double hooks, using aux. hook)															
Rear counterweight 60t, Carbody counterweight 20t, Gauge 7.35m, Ground level 0.57°, with fixed jib															
Radius (m)	Boom length (m)														Radius (m)
	47.2		51.9		56.6		61.3		66.0		70.7		75.4		
Off-set angle	30°	45°	30°	45°	30°	45°	30°	45°	30°	45°	30°	45°	30°	45°	Off-set angle
3															3
3.5															3.5
4															4
4.5															4.5
5															5
5.5															5.5
6															6
7															7
8															8
9															9
10															10
11	27.7	27.7													11
12	27.7	27.7	23.1	23.1											12
13	27.7	27.7	23.1	23.1	20.0	20.0									13
14	27.7	27.7	23.1	23.1	20.0	20.0	14.5	14.5							14
16	27.7	27.7	23.1	23.1	20.0	20.0	14.5	14.5	14.7	14.7					16
18	27.7	27.7	23.1	23.1	20.0	20.0	14.5	14.5	14.7	14.7	12.4	12.4	10.2	10.2	18
20	25.1	25.3	22.6	22.6	20.0	20.0	14.5	14.5	14.7	14.7	12.4	12.4	10.0	10.0	20
22	21.4	21.6	20.8	20.8	18.4	18.4	14.5	14.5	14.7	14.7	12.4	12.4	9.1	9.1	22
24	18.4	18.6	18.1	18.3	16.9	16.9	14.5	14.5	14.3	14.3	12.4	12.4	8.3	8.3	24
26	16.0	16.1	15.7	15.8	15.7	15.7	14.2	14.2	13.3	13.3	12.4	12.4	7.6	7.6	26
28	13.9	14.0	13.6	13.7	13.6	13.7	13.2	13.2	12.3	12.3	11.7	11.7	6.9	6.9	28
30	12.1	12.2	11.9	11.9	11.9	12.0	12.0	12.1	11.5	11.5	10.9	10.9	6.4	6.4	30
32	10.6	10.6	10.3	10.4	10.3	10.4	10.5	10.6	10.7	10.7	10.2	10.2	5.8	5.8	32
34	9.2	9.3	9.0	9.1	9.0	9.1	9.2	9.3	9.5	9.6	9.5	9.5	5.4	5.4	34
36	8.1		7.8	7.9	7.8	7.9	8.0	8.1	8.3	8.4	8.7	8.7	4.9	4.9	36
38	7.0		6.8	6.8	6.8	6.8	7.0	7.1	7.3	7.4	7.6	7.7	4.5	4.5	38
40	6.1		5.8		5.9	5.9	6.1	6.1	6.4	6.4	6.7	6.8	4.2	4.2	40
42	5.2		5.0		5.0	5.1	5.2	5.3	5.5	5.6	5.9	5.9	3.8	3.8	42
44			4.2		4.3		4.5	4.5	4.8	4.8	5.1	5.2	3.5	3.5	44
46			3.6		3.6		3.8		4.1	4.1	4.5	4.5	3.2	3.2	46
48					3.0		3.2		3.5	3.5	3.8	3.9	3.0	3.0	48
50					2.4		2.6		2.9		3.3	3.3	2.7	2.7	50
52							2.1		2.4		2.7		2.5	2.5	52
54							1.6		1.9		2.3		2.2	2.3	54
56									1.5		1.8		1.8		56
58									1.0		1.4		1.4		58
60											1.0		1.0		60
n	4	4	4	4	4	4	4	4	4	4	4	4	1	1	n
S2	0.92	0.92	0.92	0.92	0.92	0.92	0.92	0.92	0.92	0.92	0.92	0.92	1	1	S2
S3	0.46	0.46	0.92	0.92	0.92	0.92	0.92	0.92	0.92	0.92	0.92	0.92	1	1	S3
S4	0.46	0.46	0.46	0.46	0.92	0.92	0.92	0.92	0.92	0.92	0.92	0.92	1	1	S4
S5	0.46	0.46	0.46	0.46	0.46	0.46	0.92	0.92	0.92	0.92	0.92	0.92	1	1	S5
S6	0.46	0.46	0.46	0.46	0.46	0.46	0.46	0.46	0.92	0.92	0.92	0.92	1	1	S6
S7	0.46	0.46	0.46	0.46	0.46	0.46	0.46	0.46	0.46	0.46	0.92	0.92	1	1	S7

Load Chart of FJh Configuration

Load chart - FJh Configuration (with aux. hook only)																
Rear counterweight 60t, Carbody counterweight 20t, Gauge 7.35m, Ground level 0.57°, with fixed jib																
Radius (m)	Boom length (m)														Radius (m)	
	14.4		19.1		23.8		28.5		33.2		37.9		42.5			
Off-set angle	30°	45°	30°	45°	30°	45°	30°	45°	30°	45°	30°	45°	30°	45°	Off-set angle	
3															3	
3.5															3.5	
4															4	
4.5	42.0	42.0	42.0	42.0											4.5	
5	42.0	41.7	42.0	42.0											5	
5.5	40.6	40.3	42.0	42.0	42.0	42.0									5.5	
6	39.2	38.9	42.0	42.0	42.0	42.0									6	
7	38.0	37.7	42.0	42.0	42.0	42.0	42.0	42.0							7	
8	34.0	33.8	38.2	38.0	41.6	41.3	42.0	42.0	42.0	42.0					8	
9	32.4	32.2	36.5	36.3	39.8	39.6	42.0	42.0	42.0	42.0	42.0	42.0			9	
10	31.2	31.0	35.0	34.8	38.3	38.1	41.1	40.9	42.0	42.0	42.0	42.0	36.3	36.3	10	
11	30.4	30.2	33.7	33.5	36.9	36.7	39.7	39.5	42.0	41.8	42.0	42.0	36.3	36.3	11	
12	30.0	29.9	32.6	32.4	35.7	35.5	38.4	38.2	40.7	40.5	42.0	42.0	36.3	36.3	12	
13			31.6	31.5	34.6	34.4	37.2	37.0	39.5	39.3	41.5	41.3	34.7	34.7	13	
14			30.9	30.8	33.6	33.5	36.1	36.0	38.4	38.2	40.5	40.3	33.3	33.3	14	
16			30.3		32.7	32.6	35.2	35.1	37.4	37.3	37.7	38.0	31.9	31.9	16	
18					30.3	30.2	32.0	32.0	32.6	32.7	31.7	31.9	28.4	28.4	18	
20					27.8		27.3	27.4	27.9	28.0	27.0	27.2	26.5	26.5	20	
22							23.6	23.6	24.2	24.3	23.3	23.5	23.9	24.1	22	
24							20.5		21.1	21.2	20.4	20.4	21.0	21.1	24	
26									18.6		17.9	17.9	18.5	18.6	26	
28									16.5		15.8	15.8	16.4	16.5	28	
30											14.0		14.6	14.7	30	
32											12.5		13.1	13.1	32	
34													11.8		34	
36													10.6		36	
38													9.5		38	
40															40	
42															42	
44															44	
46															46	
48															48	
50															50	
52															52	
54															54	
56															56	
58															58	
60															60	
62															62	
64															64	
n	5	5	5	5	5	5	5	5	5	5	5	5	4	4	n	
S2	0	0	0	0	0.46	0.46	0.46	0.46	0.46	0.46	0.46	0.46	0.46	0.46	S2	
S3	0	0	0	0	0.46	0.46	0.46	0.46	0.46	0.46	0.46	0.46	0.46	0.46	S3	
S4	0	0	0.46	0.46	0	0	0.46	0.46	0.46	0.46	0.46	0.46	0.46	0.46	S4	
S5	0	0	0	0	0	0	0	0	0.46	0.46	0.46	0.46	0.46	0.46	S5	
S6	0	0	0	0	0	0	0	0	0	0	0.46	0.46	0.46	0.46	S6	
S7	0	0	0	0	0	0	0	0	0	0	0	0	0.46	0.46	S7	

Load Chart of FJh Configuration

Load chart - FJh Configuration (with aux. hook only)															
Rear counterweight 60t, Carbody counterweight 20t, Gauge 7.35m, Ground level 0.57°, with fixed jib															
Radius (m)	Boom length (m)														Radius (m)
	47.2		51.9		56.6		61.3		66.0		70.7		75.4		
Off-set angle	30°	45°	30°	45°	30°	45°	30°	45°	30°	45°	30°	45°	30°	45°	Off-set angle
10															10
11	27.7	27.7													11
12	27.7	27.7	23.1	23.1											12
13	27.7	27.7	23.1	23.1	20.0	20.0									13
14	27.7	27.7	23.1	23.1	20.0	20.0	14.5	14.5							14
16	27.7	27.7	23.1	23.1	20.0	20.0	14.5	14.5	14.7	14.7	12.4	12.4			16
18	27.7	27.7	23.1	23.1	20.0	20.0	14.5	14.5	14.7	14.7	12.4	12.4	10.2	10.2	18
20	25.6	25.6	22.6	22.6	20.0	20.0	14.5	14.5	14.7	14.7	12.4	12.4	10.0	10.0	20
22	23.3	23.4	20.8	20.8	18.4	18.4	14.5	14.5	14.7	14.7	12.4	12.4	9.1	9.1	22
24	20.3	20.4	19.2	19.2	16.9	16.9	14.5	14.5	14.3	14.3	12.4	12.4	8.3	8.3	24
26	17.9	18.0	17.6	17.7	15.7	15.7	14.2	14.2	13.3	13.3	11.7	11.7	7.6	7.6	26
28	15.8	15.9	15.5	15.6	14.6	14.6	13.2	13.2	12.3	12.3	10.9	10.9	6.9	6.9	28
30	14.0	14.1	13.8	13.9	13.6	13.6	12.3	12.3	11.5	11.5	10.2	10.2	6.4	6.4	30
32	12.5	12.6	12.3	12.3	12.3	12.4	11.5	11.5	10.7	10.7	9.5	9.5	5.8	5.8	32
34	11.2	11.2	10.9	11.0	11.0	11.0	10.7	10.7	10.0	10.0	8.9	8.9	5.4	5.4	34
36	10.0		9.8	9.8	9.8	9.9	10.0	10.0	9.3	9.3	8.4	8.4	4.9	4.9	36
38	9.0		8.7	8.8	8.8	8.8	9.0	9.0	8.8	8.8	7.9	7.9	4.5	4.5	38
40	8.0		7.8		7.9	7.9	8.1	8.1	8.2	8.2	7.4	7.4	4.2	4.2	40
42	7.2		7.0		7.0	7.0	7.2	7.3	7.5	7.6	7.0	7.0	3.8	3.8	42
44			6.2		6.3		6.5	6.5	6.8	6.8	6.5	6.5	3.5	3.5	44
46			5.5		5.6		5.8		6.1	6.1	5.9	5.9	3.2	3.2	46
48					5.0		5.2		5.5	5.5	5.3	5.3	3.0	3.0	48
50					4.4		4.6		4.9		4.8		2.7	2.7	50
52							4.1		4.4		4.3		2.5	2.5	52
54							3.6		3.9		3.8		2.3	2.3	54
56									3.5		3.4		2.1		56
58									3.1		3.0		1.9		58
60											2.7		1.7		60
62													1.6		62
64													1.4		64
n	4	4	4	4	4	4	4	4	4	4	4	4	1	1	n
S2	0.92	0.92	0.92	0.92	0.92	0.92	0.92	0.92	0.92	0.92	0.92	0.92	1	1	S2
S3	0.46	0.46	0.92	0.92	0.92	0.92	0.92	0.92	0.92	0.92	0.92	0.92	1	1	S3
S4	0.46	0.46	0.46	0.46	0.92	0.92	0.92	0.92	0.92	0.92	0.92	0.92	1	1	S4
S5	0.46	0.46	0.46	0.46	0.46	0.46	0.92	0.92	0.92	0.92	0.92	0.92	1	1	S5
S6	0.46	0.46	0.46	0.46	0.46	0.46	0.46	0.46	0.92	0.92	0.92	0.92	1	1	S6
S7	0.46	0.46	0.46	0.46	0.46	0.46	0.46	0.46	0.46	0.46	0.92	0.92	1	1	S7

Note:

- ① . The rated load values listed in the Load Charts are calculated on the conditions that the machine is parking on firm and level ground, with load lifted up slowly and steadily, not when it is traveling.
- ② . The weight of hook, riggings and wire rope are included in the rated load values listed in the Load Charts.
- ③ . The rated load values in the load chart is calculated when the wind speed under 9.8m/s.
- ④ . The load charts are valid for swing of 360° .
- ⑤ . The rated load capacity is less than 10.5t when using boom tip sheave block.
- ⑥ . If the actual boom length and radius are within the two values in the table, the lifting capacity for operation shall be determined by the larger boom length and radius.
- ⑦ . The fixed jib shall not unfolded when there is load on the main hook.
- ⑧ . The crane is not allowed to work outside the Load Chart provided.



Zhejiang Sany Equipment Co.,LTD

SANY Crawler Crane Industrial Park, No. 2188 Daishan Road, Wuxing District, Huzhou City,
Zhejiang Province, P. R. China Zip 313028
Consulting sanycrane@sanygroup.com (Crane BU) / crd@sany.com.cn (IHQ)
After-sales Service 0086-400 6098 318

Reminder:

Any change in the technical parameters and configuration due to product modification or upgrade may occur without prior notice.
The machine in the picture may include additional equipment. This brochure is for reference only, and goods in kind shall prevail.
Copyright at SANY. No part of this brochure may be copied or used for any purpose without written approval from SANY.

© Edited in June 2023

