

SPECIFICATION



60t



50m



66.5m

SAC600E

SANY ALL TERRAIN CRANE

QUALITY CHANGES THE WORLD

crane.sanyglobal.com

It is one of the core business units in SANY Group, specializing in the development and manufacturing of high-end wheel cranes, crawler cranes and tower cranes, including the complete range of wheel cranes from 8 to 2400t, crawler cranes from 25 to 4500t and tower cranes from 6 to 185t.

三一集团旗下核心事业部，从事高端轮式起重机、履带起重机、塔式起重机系列产品的研发制造。覆盖8-2400吨全吨位轮式起重机，25-4500吨全吨位履带起重机，6-185吨塔式起重机。



SANY CRANE



SAC600E

SANY ALL TERRAIN CRANE
60T LIFTING CAPACITY

SAC600E is an all-terrain crane with 60t lifting capacity, 6 boom sections totaling 50m, and features wireless remote control of motions, optional anti-electromagnetic interference module, and the brand-new iCab, with driving and operation comfort fully upgraded.

一款最大起重量60吨、6节臂、全伸主臂50米的全地面起重机，动作可以实现无线遥控，可选装抗电磁干扰模块，配备全新上下驾驶室——iCab，驾驶、操作舒适度全面升级。



50m boom

Boom full extension 50m

50m主臂

主臂全伸50m

Wireless remote control

无线遥控



Anti-electromagnetic interference

An anti-electromagnetic interference module adopted, enabling well functioning under strong electric and magnetic conditions (excluding wireless operations)

抗电磁干扰

通过抗电磁干扰模块可以实现在强电强磁下的正常工作 (不含无线操作)

All new iCab design

Ergonomic concept of safety and comfort

全新两室

操作安全、舒适、人机工程全面升级



i-Cab - Driver's cab

新两室 - 驾驶室

Multi-function seat with air suspension, making driving more comfortable.
Double seats and foldable berth for the co-driver.
10.1-inch touch screen integrated with back-up image and multi-media.
Electric rearview mirror with electric heating, ensuring good field of view in foul weather.
Adjustable high-brightness LED headlamps/fog lamps, providing clear vision at night.
Full-automatic HVAC, able to automatically adjust indoor temperature as demanded.

主驾驶位配备气浮多功能座椅, 驾驶更舒适。
副驾驶位设置双座椅可折叠式卧铺。
10.1英寸触摸大显示屏, 集成倒车影像、影音娱乐功能。
电动、电加热后视镜, 不惧怕恶劣冰雪天气。
高亮度可调节 LED 大灯 / 雾灯, 提供夜间清晰视野。
全自动冷暖空调, 自动根据需求调整室内温度。





i-Cab - Operator's cab

新两室 - 操纵室

Seat widened by 480mm, and leg room increased by 30%.
Cab tiltable by 0-20°, relieving cervical fatigue during large-angle and long-boom operations.
Adjustable seat with maximum inclination of 140°, allowing the operator to lie flat and rest after work.
Electric seat linked with armrest box, enabling multi-dimensional adjustment for enhanced comfort.
Electronic control joysticks, making operation easier.
45° tilted silicone button panel, easy to reach and operate.
70° openable front window convenient for ventilation and escape; in compliance with CE standards.
Sliding door, more convenient for getting on/off the cab and opening/closing the door.
Full-automatic HVAC, able to automatically adjust indoor temperature as demanded.

座椅加宽至 480mm, 腿部活动空间较上一代增加 30%。
操纵室可实现 0-20° 上仰变位, 在大角度、长臂段作业时减缓颈椎疲劳。
可调式座椅, 最大后仰 140°, 让操作手可以平躺休息。
电动座椅 + 扶手箱联动, 多维度调节, 更加舒适。
电控操纵手柄, 操作毫不费力。
45° 斜置硅胶按键面板, 触手可及, 方便操控。
70° 可开启式前窗, 方便通风及逃生、操作室满足 CE 要求。
手动滑移门, 上下车、开关门更方便。
全自动冷暖空调, 自动根据需求调整室内温度。



Anti-electromagnetic Interference (Optional) 抗电磁干扰(选配)

Anti-electromagnetic interference module, allowing the crane to work normally in strong electric field or strong magnetic field ($\leq 20\text{v/m}$ and $>500\text{m}$ away from interference source), including cluster construction of high-power equipment, and the vicinity of multiple interference sources including high-voltage lines, broadcasting base stations, power plants, aluminum plants, radar stations, military bases or mobile communication stations.

配备抗电磁干扰模块, 实现在磁场强度不大于 20v/m 、距干扰源 500 米范围外的强电场、强磁场, 如大功率设备集群化施工, 紧邻高压线、广播基站、电厂、铝厂、雷达基站、军事基地或移动设备等通信基站附近多个干扰源的环境中正常工作。



Wireless Remote Control System 无线遥控系统

Main functions

Outrigger control - single-piece / single-side outrigger beam and jack telescoping in/out, and one-button leveling;
Crane operation - boom telescoping, luffing, slewing, hoisting;
Auxiliary action control - counterweight lifting/lowering, jib pushing/pulling, side step extension/retraction, cab tilting, etc.

主要功能

支腿控制——单个和单边支腿水平伸缩、垂直起落, 并支持一键调平;
上车作业——实现伸缩臂、起落幅、回转、卷扬收放绳;
辅助动作操作——配重起落、副臂推拉、踏板伸缩、操作室变位等辅助操作。

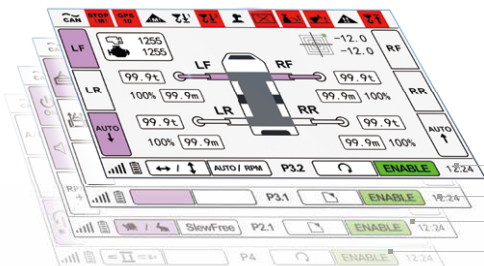

- Outrigger status 支腿界面
- Counterweight lifting/lowering, step extension/retraction 配重起落、踏板伸缩
- Main parameters 主参数展示界面
- Boom telescoping 起重臂伸缩界面

Working Condition

工况组合

T: Boom 主臂

Max. lifting capacity 最大起重量	60t
Max. boom length 最大臂长	50m
Max. radius 最大幅度	39m
Max. height 最大高度	50.5m

TA: Boom + auxiliary jib (optional) 主臂 + 鹅头臂 (选配)

Max. lifting capacity 最大起重量	9.1t
Max. boom + jib length 最大臂长	53m
Max. radius 最大幅度	40m
Max. height 最大高度	53.5m

TH: Boom + hydraulically adjustable jib (optional) 主臂 + 液压变幅副臂 (选配)

Max. lifting capacity 最大起重量	7.9t
Max. boom + jib length 最大臂长	66m
Max. radius 最大幅度	44m
Max. height 最大高度	66.5m

TJ: Boom + fixed jib (optional) 主臂 + 机械变幅副臂工况 (选配)

Max. lifting capacity 最大起重量	7.9t
Max. boom + jib length 最大臂长	66m
Max. radius 最大幅度	44m
Max. height 最大高度	66.5m



Travel Flexibility

通过能力

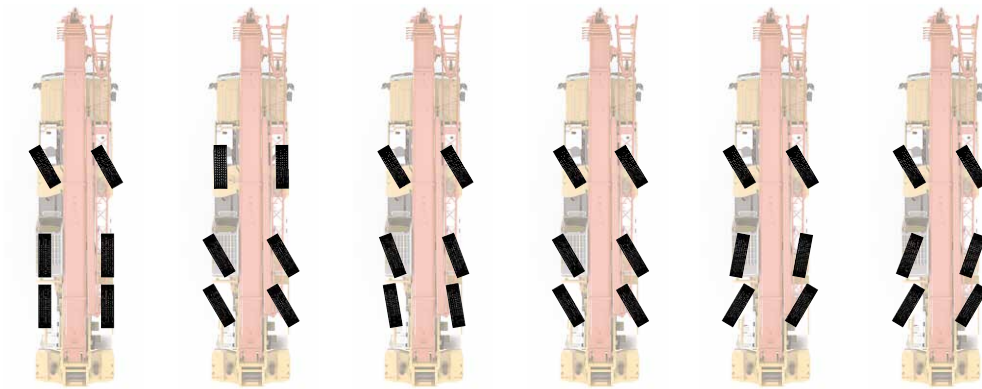

Independent front axle steering 后桥锁定转向模式

Independent rear axle steering 独立后桥转向模式 *

Reduced swing-out steering 无偏摆转向模式

Crab steering 蟹行模式 *

On-road driving 公路行驶模式 *

All-wheel steering 全轮转向模式 *

ME steering system: four modes available marked by asterisk *, standard on E5 version

Sany steering system: six modes available, standard on E3A version.

ME转向系统：4种模式，见上文带星号，E5版标配

三一转向系统：6种模式，E3A版标配

Traveling with counterweight and hook block on board

带载行驶能力



≤16t

≤16t

≤16t

≡ 13t



≤12t

≤12t

≤12t

≡ 4.2t

Carrier Frame

车架底盘

High strength frame

Carrier frame welded with fine grain high-strength steel plates of box-type section, providing a stronger anti-torsion capability than C-type or H-type construction.

Stable support

H-type outriggers of 4-point support, which is of same material and design as frame, and helps improve the stability of operation.

高强车架

车架采用细晶粒高强度钢板焊接而成,主截面采用抗扭的箱型结构,相比 C 型和工字型结构抗扭矩能力更强。

稳定支腿

与车架采用相同的材质及设计结构,使用传统的“H”型 4 点支撑布置,确保作业稳定性。

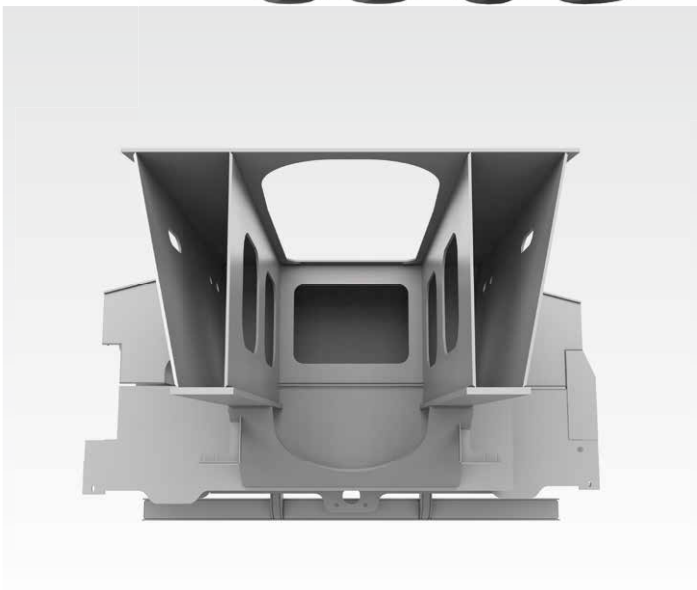

Power Train

动力系统

Engine

Mercedes-Benz OM470LA off-road in-line six cylinder water-cooled diesel engine, complying with Stage III or Stage V emission standards.
 Rated power: 280kW/1700rpm (E3A) / 280kW/1600rpm (E5).
 Max. torque: 1900Nm/1300rpm.
 Fuel reservoir capacity: 400L.

Transmission

Allison 4500SP 6-speed AT with three-phase torque converter and planetary gear, allowing for smooth start and smooth gearshift.

Braking system

Braking system consisting of disc brake, air chamber and ABS, making the braking performance more reliable and efficient. Optional eddy current retarder, allowing for effective assist braking, reducing the wear of axle brake linings and prolonging service life. Parking brake and service brake equipped for axles 1, 2, 3.

Axles and suspension

Kessler axles with high bearing capacity and reliable quality. Hydro pneumatic suspension system with stroke of $\pm 100\text{mm}$.
 Standard 6×4 drive mode, with axles 2, 3 driven.
 Optional 6×6 drive mode, with axles 1, 2, 3 driven.

Steering system

Dual-circuit power steering gear, and dual-circuit power steering system, with all axles steered.

发动机

奔驰 OM470LA 非道路直列 6 缸水冷柴油机, 可满足欧三、欧五排放法规要求。
 额定功率 :280kW/1700rpm (E3A) / 280kW/1600rpm (E5)。
 最大扭矩 :1900Nm/ 1300rpm。
 燃油箱容积 400L。

变速箱

Allison 4500SP 使用三相变扭器和行星齿轮的 6 档 AT 自动变速箱, 使车辆起步平稳, 换挡平顺。

制动系统

由盘式制动器, 制动气室, ABS 主要配件系统组成, 制动性能更加可靠、高效。可选装电涡流缓速器, 可有效进行辅助制动, 减少车桥制动片磨损, 提高制动片使用寿命。1 桥、2 桥、3 桥配置驻车制动和行车制动。

车桥悬架

采用 Kessler 车桥, 承载能力强, 质量可靠。采用油气悬挂系统, 悬挂行程 $\pm 100\text{mm}$ 。
 标配 6×4 驱动模式下, 2、3 桥为驱动桥。
 (选配) 6×6 驱动, 1、2、3 为驱动桥。

转向系统

双回路助力转向器, 双回路转向助力系统, 1 桥、2 桥、3 桥都为转向桥。



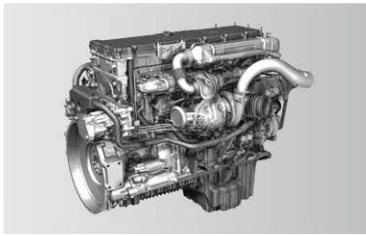

 Mercedes-Benz

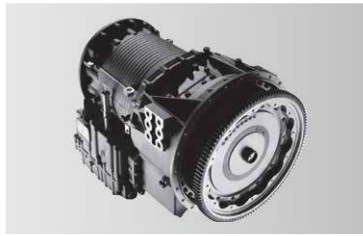

 Allison
Transmission

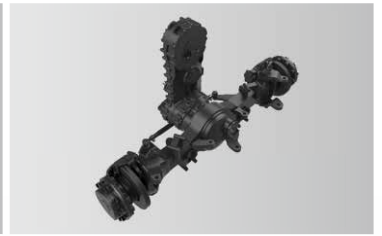

KESSLER·CO

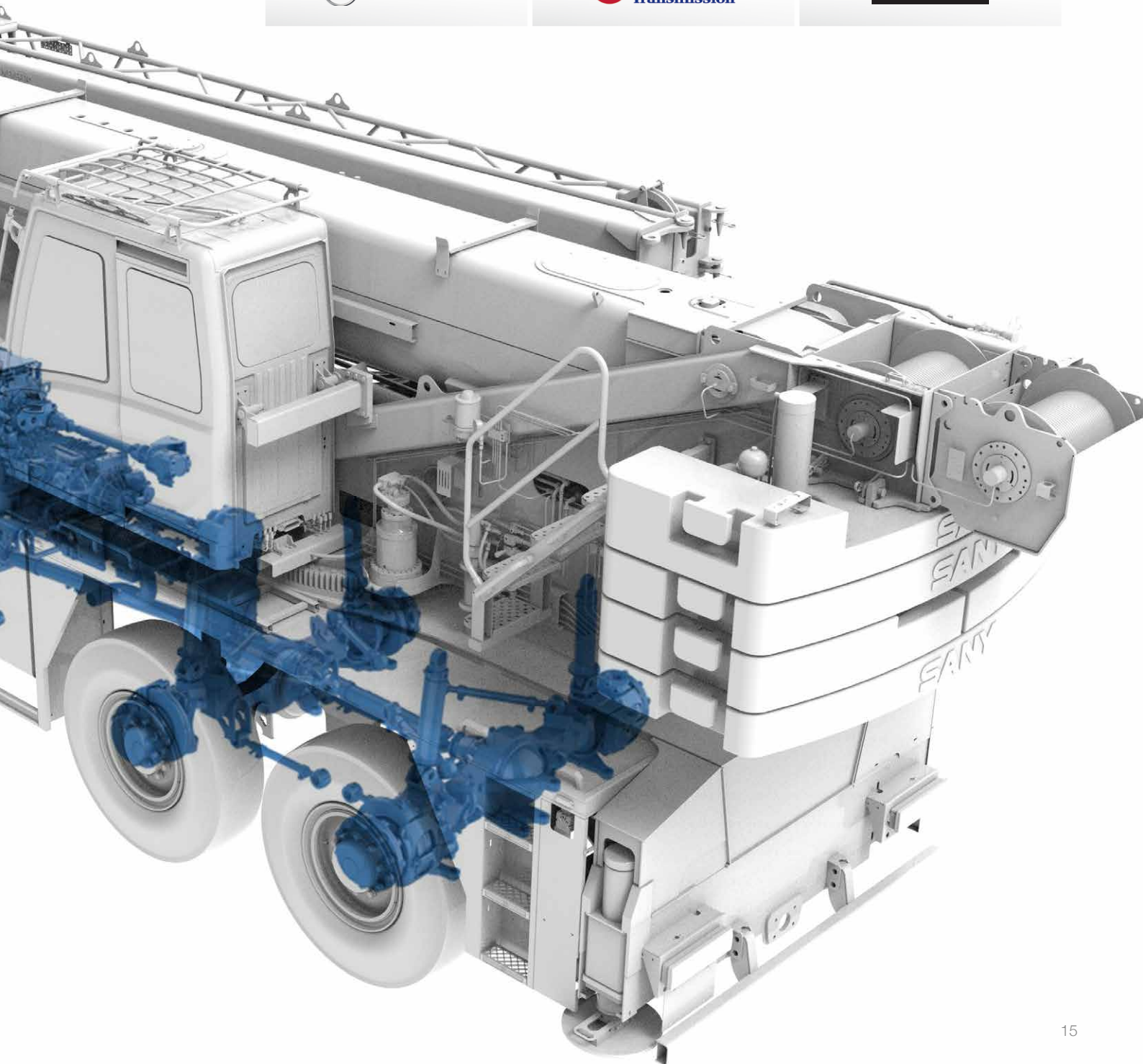

Electrical System

电气系统

Smart CAN-BUS communication system

International advanced CAN-BUS data communication network. CAN-BUS networking applied for display, instrument panel, I/O module and main sensors, allowing for high-speed data transmission, and quick response less than 20ms.

Smart fault diagnosis system

The chassis adopts safety controller functioning smart monitoring, BCM power distribution management and integrated with fault diagnosis system.

AEC-approved console screen

Integrating functions including suspension control, steering control, outrigger control and data calibration.

Precise load moment indicator

SANY independently developed high-precision LMI, with an accuracy of 0~5%.

Cabling

Centralized junction box and heavy-duty connector applied for cabling of superstructure, convenient for maintenance; IP rating up to IP67, ensuring high reliability.

Winch monitoring system

Winch cameras equipped for monitoring its working condition and identifying rope disorder in time.

Integrated bus button panel input

Various operating states displayed by button indicator lights, and one-button multi-functional operation realizable by writing various operation modes.

智能总线通信系统

国际先进的分布式集成总线数据通信网络。显示器、显示仪表、I/O 模块、主要传感器等采用 CAN 总线组网, 高速信息传输、响应速度小于 20ms。

智能故障诊断系统

底盘采用安全主控制器操作装置带智能监控、BCM 配电管理, 拥有故障诊断系统。

车规级中控屏

集成悬挂、转向、支腿、数据标定等作业功能。

精准力限器系统

三一自主研发的高精度力矩限制器系统。

电缆布线

上车电缆布线采用集中式分线盒及重载接插件, 维护方便; 防护等级 IP67, 可靠性高。

卷扬监控系统

卷扬摄像头监视卷扬工作及时发现乱绳的情况。

集成总线按键面板输入

可通过按键指示灯显示各种工作状态, 通过写入多种操作模式实现一键多功能。



Anti-two-block switch
高度限位器



Third wrap indicator
三圈保护器



Cable reel
电缆卷筒



Cable reel inside the boom
臂内卷筒



Anemometer
风速仪

MachineLink+

ROOTCLOUD T-AMS Pro device comes as standard to realize GPS trajectory, machine status, maintenance management, alarm management on computer or mobile MachineLink+ platform, by remote control of cranes. This telematics package greatly boosts efficiency of customer fleet management and helps provide better after-sales services.

标配树根物联终端 T-AMS Pro, 通过对起重机设备的远程控制, 在电脑或移动端 MachineLink+ 平台实现轨迹回放、设备状态、维保设备、报警管理等功能, 极大提高客户设备管理效率, 提升三一售后服务能力。

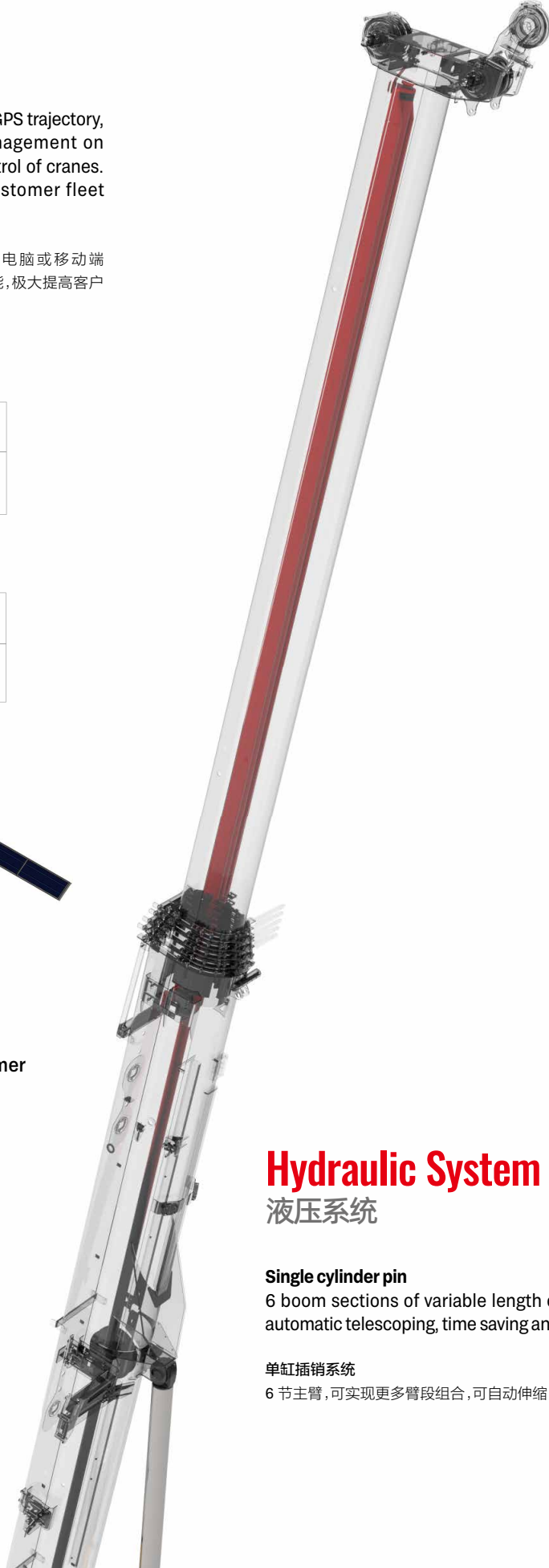

Hydraulic System 液压系统

Single cylinder pin

6 boom sections of variable length combinations, automatic telescoping, time saving and labor saving.

单缸插销系统

6 节主臂, 可实现更多臂段组合, 可自动伸缩, 省时省力。

Superstructure

上车

Open-type electronically controlled load-sensing system and closed-type slewing system, enabling combined operation of four actions at the same time.

Electro proportional compensated passive luffing-down system applied to control the luffing speed, making luffing more reliable and stable.

Closed-type slewing system, ensuring no pressure loss and no overflowing noise upon start/stop, and making the operation quieter and more energy-saving.

Electronically controlled load-sensing hydraulic system, electronic joystick and electronic throttle, ensuring easy operation and more accurate control and millisecond-level action response speed, with min. single-rope hoisting speed $\leq 1\text{m}/\text{min}$.

通过开放式电控负载敏感系统和闭式回转系统，可同时实现四动作联动；

电比例自重落幅系统控制落幅速度，更可靠更平稳；

采用闭式回转系统，停启时无压力损失，无溢流噪声，更安静，更节能；

电控负载敏感液压系统，采用电手柄、电油门控制，轻松操作的同时，控制更精准；动作响应毫秒级速度；卷扬单绳最低速度 $\leq 1\text{m}/\text{min}$ 。

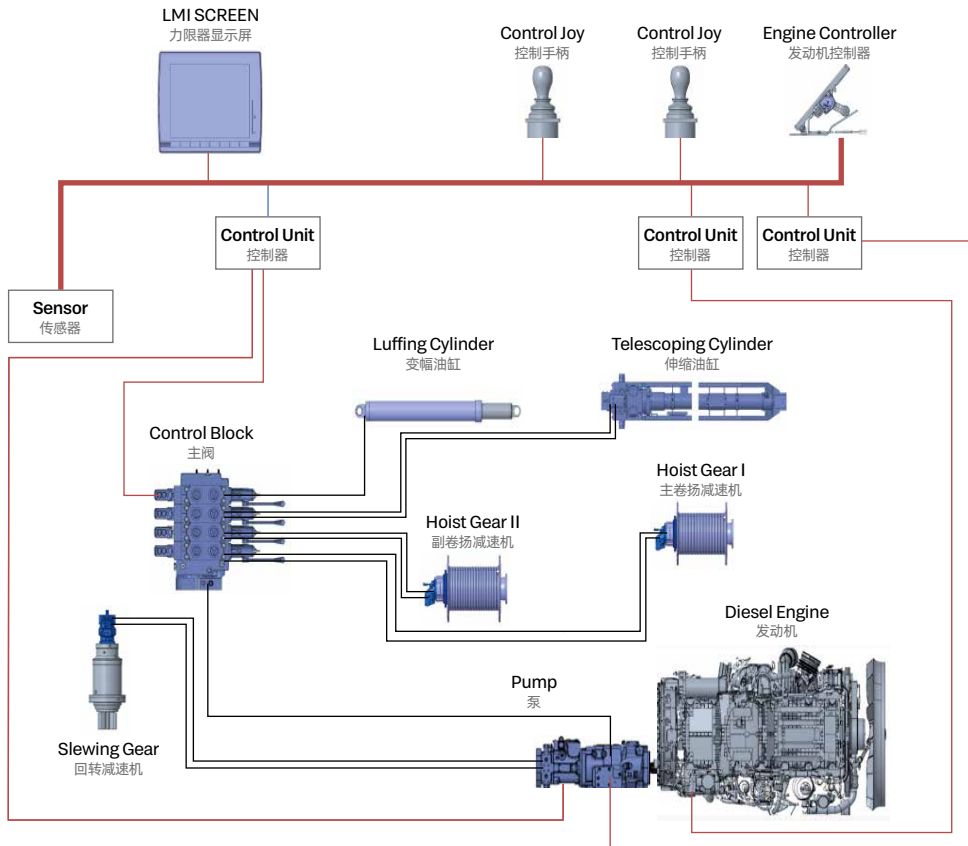

Chassis

下车

Dual circuit + emergency main steering system

Main steering system: Dual oil pump directly connected to the engine to supply oil independently to the steering gear, ensuring efficient and reliable steering.

Emergency steering system: A bidirectional piston pump installed on the transfer case, ensuring steering assistance throughout the traveling.

Electro-hydraulic assisted steering system

A load-sensing piston pump installed to supply oil for assisted steering, which is directly connected to the engine and always in the standby mode, so that the assisted steering system can respond quickly once the assisted steering command is received.

Suspension system

A piston pump adopted as the power source of suspension system, and suspension modes electrically controlled to realize normal driving and driving with CW on board with suspension locked.

Outrigger telescoping system

Full-electric control of outrigger, auto leveling available.

双回路+应急主转向系统

主转向系统：双联油泵与发动机直连，独立对方向机供油，主转向高效、可靠；

应急转向系统：采用双向柱塞泵，安装在分动箱上，确保车辆行进过程中始终有转向助力。

电液辅助转向系统

辅助转向采用负载敏感柱塞泵提供油源，该油泵与发动机直连，油泵始终处于转向待机模式，一旦接到辅助转向指令，辅助转向系统能够快速响应。

悬挂系统

悬挂系统采用柱塞泵作为动力油源，操作方式采用电控，通过选择不同的悬挂模式可以实现正常行驶和锁定模式下的带载行驶。

支腿伸缩系统

支腿伸缩采用全电控方式，可实现支腿的无级伸缩，电控模式下可实现整车自动调平。

Overall Dimensions

整机尺寸

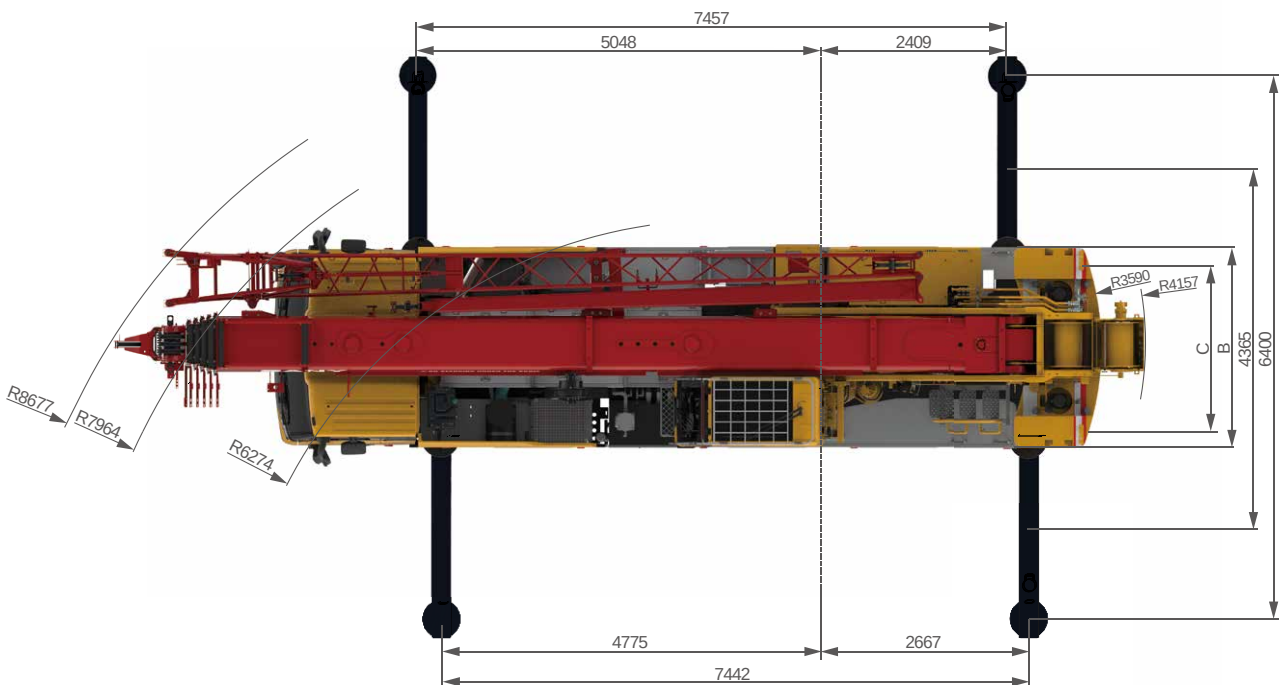
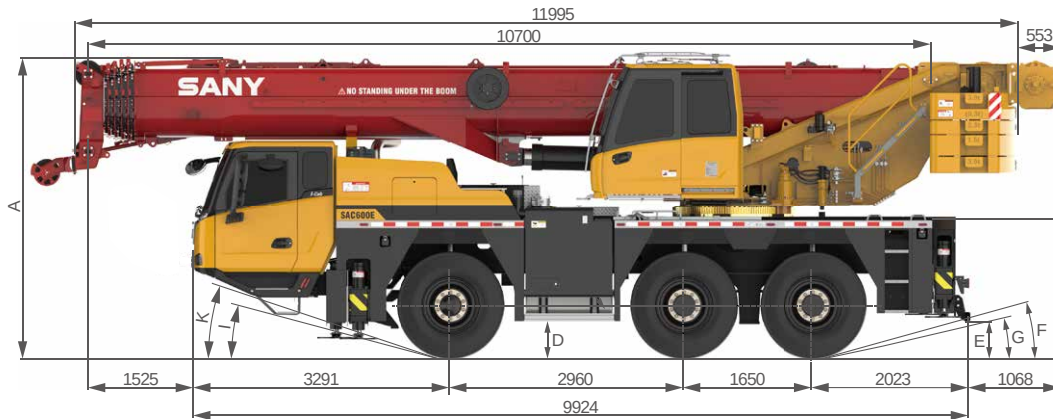

Tire size 轮胎尺寸	A	A*	B	C	D	E	F	G	I	K
Unit 单位	mm	mm	mm	mm	mm	mm	°	°	°	°
385/95R25	3877	3777	2550	2170	436	374	18	12	13	15
445/95R25	3927	3827	2550	2100	486	424	20	14	15	18

Remark: A column is calculated when suspension is at middle level. A* column is calculated when suspension is at lowest level.
 备注: A 列为悬挂处于中位, A* 列为悬挂处于最低位。

Technical Specification

整机参数

CATEGORY 类型	ITEM 项目	UNIT 单位	VALUE 参数	
POWER 发动机参数	Engine model (Emission standard) 发动机型号及排放	-	OM470.E3A-3 (Stage III) OM470LA.E5-4 (Stage V)	
	Max. engine power 发动机最大功率	kW/rpm	280/1700 (Stage III) 280/1600 (Stage V)	
	Max. engine torque 发动机最大输出扭矩	N·m/rpm	1900/1300	
TRAVEL 行驶参数	Max.travel speed 最高行驶速度	km/h	80	
	Steering radius 转弯半径	Min.steering radius 最小转弯半径	m	6.5
		Min.steering radius of boom tip 臂头最小转弯半径	m	10
	Wheel formula 车轮模式	-	6 × 4 × 6	
	Min.ground clearance 最小离地间隙	mm	320 (#385 tires)	
	Max.gradeability 最大爬坡度	-	60%	
MAIN PERFORMANCE 主要性能参数	Working temperature range 使用温度区间	℃	-20~45	
	Min.rated lifting radius 最小额定幅度	m	3	
	Tail slewing radius 转台尾部回转半径	m	3.59	
	Boom sections (Qty.) 臂节数	-	6	
	Boom shape 臂形状	-	U shape U 型	
	Max.lifting moment 最大起重力矩	Basic boom 基本臂	kN·m	1861
		Full-extension boom 全伸主臂	kN·m	966
		Full-extension boom+jib 全伸主臂 + 副臂	kN·m	713
	Boom length 臂长	Basic boom 基本臂	m	10.7
		Full-extension boom 全伸主臂	m	50
		Full-extension boom+jib 全伸主臂 + 副臂	m	66
	Max.lifting height 最大起重高度	Basic boom 基本臂	m	11
		Full-extension boom 全伸主臂	m	50.5
Full-extension boom+jib 全伸主臂 + 副臂		m	66.5	
Outrigger span (Longitudinal × Transverse) 支腿跨距 (纵 × 横)	m	7.45 × 6.4		
Jib offset 副臂安装角度	°	0, 20, 40		
AIRCONDITIONER 空调	In operator's cab 上车空调	-	Heating & Cooling 制冷、制热	
	In driver's cab 下车空调	-	Heating & Cooling 制冷、制热	

Technical Specification

整机参数



Axle Load 轴荷

Axle load 轴荷	Total weight 总重	Drive 传动模式	Tire 轮胎	Fixed CW 固定配重 (t)	Jib bracket 副臂托架	Attachment 携带附件
<12t	≤36t	6 × 6	385/95R25 alu	4.2	/	6.3t hook placed at frame tail bucket 6.3t钩(放置在车尾副钩固定桶中)
<12t	≤36t	6 × 4	445/95R25 alu	4.2	/	/
<12t	≤36t	6 × 4	385/95R25	4.2	/	6.3t hook placed at frame tail bucket 6.3t钩(放置在车尾副钩固定桶中)
≤16t	<47t	6 × 6	445/95R25	13	/	32t hook attached in front of driver's cab, auxiliary winch, rear tool box and attachments 350kg 32t吊钩放置于驾驶室前方, 副卷扬, 后工具箱及附件350kg



Operations 主要动作参数

Item 项目	Single rope speed 单绳速度	Rope diameter/length 钢丝绳直径 / 长度	Max. single line pull 最大单绳拉力
Main winch 主卷扬	130m/min	15mm/220m	47.7kN
Auxiliary winch 副卷扬	130m/min	15mm/220m	47.7kN
Slewing 回转		1.6r/min	
Luffing 起落幅		60s/90s	
Telescoping 伸缩		350s	
Outrigger jack 垂直支腿	Retract 收	40s	
	Extend 放	50s	
Outrigger beam 水平支腿	Retract 收	40s	
	Extend 放	50s	



Hook 吊钩

Type 型号	Load 起重量	Number of sheaves 滑轮数量	Rope rate 倍率	Hook weight 吊钩重量 /kg
63t	60t	7	14	463
50t	48.9t	5	11	406
32t	32t	3	7	323
16t	14.2t	1	3	215
6.3t	4.8t	-	1	108

Counterweight Combinations

配重组合

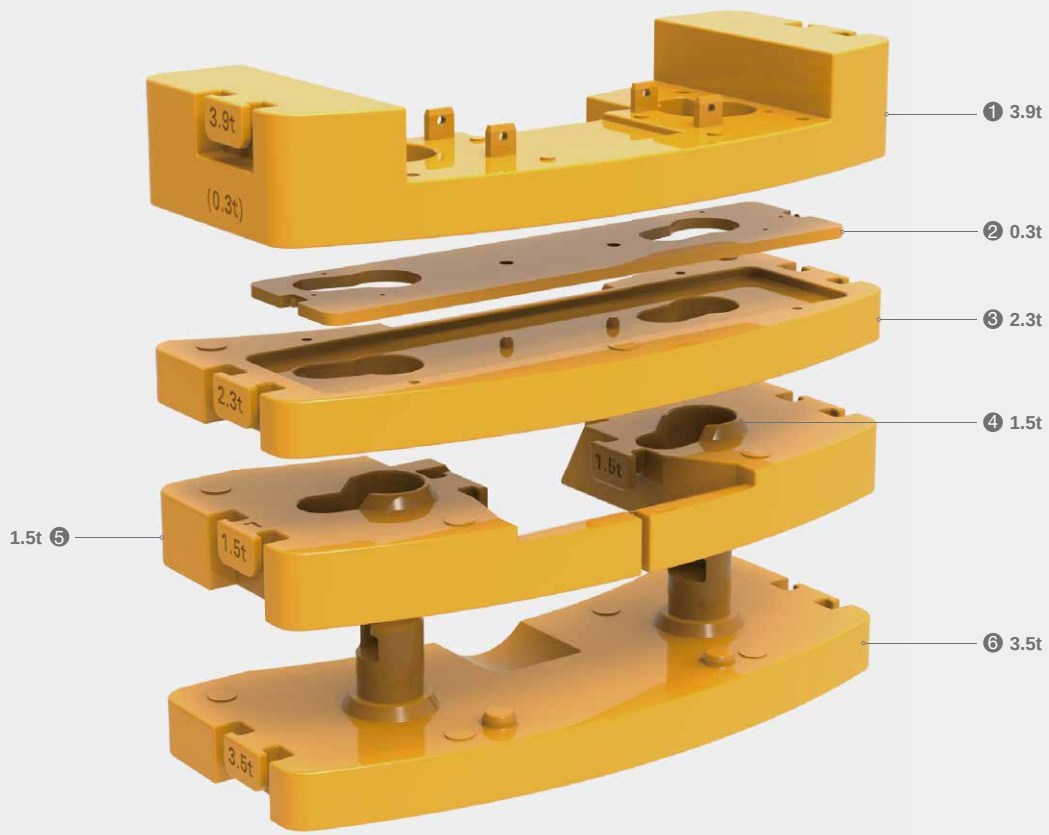

Total weight 总重量	①	②	③	④	⑤	⑥
3.9t	•					
4.2t	•	•				
6.5t	•	•	•			
10t	•	•	•			•
13t	•	•	•	•	•	•

Transport Dimensions

运输尺寸

Unit:mm

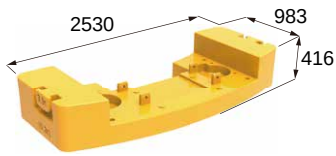

3.9t

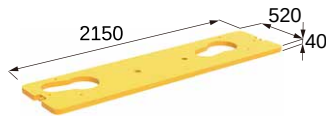

0.3t

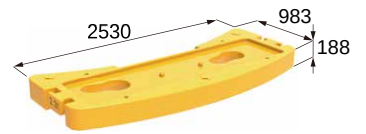

2.3t



1.5t

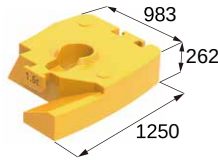

1.5t

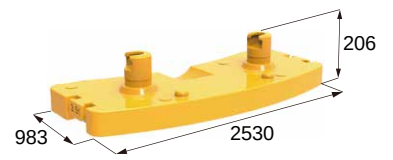

3.5t



32t hook block



16t hook block



6.3t hook block

Crane Introduction

整机介绍

Carrier 下车

Carrier frame 车架

- Box-type welded structure using high strength steel plate, higher bearing capacity.
- 车架为高强度钢板焊接而成的箱形结构，承载能力强。

Engine 发动机

- BENZ OM470LA in-line six-cylinder diesel engine with watercooler and inter cooler, complying with EU Stage III / EU Stage V emission standard.
- Fuel reservoir capacity: 400L.
- 型号：奔驰 OM470LA，直列六缸、水冷却、增压中冷、柴油发动机；排放符合欧三 / 欧五标准。
- 燃料箱有效容积：400L。

Transmission 变速箱

- Allison auto-transmission, 6 forward gears and 1 reverse gears, large speed ratio range, high torque output.
- Allison 自动变速箱，6 个前进档、1 个后退档，速比范围大，输出扭矩高。

Axle 车桥

- All wheel steering. Planetary transmission with differential lock. Driven by axles 2 and 3 (standard equipment).
- Axle 1 steered mechanically with hydraulic booster, axles 2 and 3 steered electro-hydraulically. Easier and better maneuverability.
- 全桥转向，行星传动带有轮间差速锁，标配 2、3 桥驱动。
- 1 桥采用杆系反馈的液压助力转向系统，2、3 桥采用电液控制转向，转向轻便，操控灵活。

Suspension 悬挂

- Hydro-pneumatic suspension with hydraulic lock, range $\pm 100\text{mm}$ in height. Smooth driving, anti-tipping.
- 全部车桥悬架装置均为带液压闭锁的油气悬架装置，悬挂高度可 $\pm 100\text{mm}$ 被动调节，保证车辆行驶的平顺性和侧翻稳定性。

Tire 轮胎

- Size 385/95R25 (standard equipment), radial tires.
- 标配：385/95R25，子午线真空胎。

Braking 制动系统

- All-wheel air brakes. Dual circuit disc service brake, optional eddy-current retarder available for prolonged life of brakes.
- 全轮气压制动器。双回路制动系统，所有车轮均装有盘式制动器。选配电涡流缓速器提前对起重机减速，可减少刹车部件的磨损，节约使用成本。

Outrigger 支腿

- H-type layout, with hydraulic cylinder, auto-levelling.
- H 形支腿，全液压伸缩，具备自动调平功能。

Control system 控制系统

- CAN-BUS communication, 24V DC, two battery sets (180Ah each), manual power-switch.
- Low energy cost (5w) integrated display system, LCD screen.
- 现代数据总线系统，24V 直流电源，2 组蓄电池组，每组 180Ah。可实现下车电源切断。
- 功率消耗小，最大仅有 5W，显示采用 LCD 液晶。

Crane Introduction

整机介绍

superstructure 上车

Operator's cab 操纵室

- Corrosion resistant bodywork of ergonomic design including softened interior trim and adjustable seat.
- 耐腐蚀钢板，配置软化内饰、可调式座椅等人性化设计。

Boom system 臂架系统

- U-shape welded structure using high strength steel, single cylinder pin mechanism. 2-stage folding jib offset at 0°, 20°, 40°.
- 主臂由高强度焊接结构钢制成，U形截面，采用单缸插销伸缩方式。二节副臂，安装角度为 0°，20°，40°。

Slewing 回转机构

- Slewing platform designed by SANY, 360° slewing. Electro-proportional closed type hydraulics for smooth operation and better inching motion performance.
- 转台由三一自主设计，360° 回转。采用电比例闭式液压回路，操纵平滑，回转微动性更好。

Hydraulics 液压系统

- DANFOSS PVG main valve, higher efficiency for single motion and better maneuverability for combined motions.
- Auto adjustable oil pump with higher power use ratio and less energy cost. Variable plunger pump featuring load sensing and constant power control.
- 采用丹佛斯 PVG 主阀，单动作效率更高，组合动作操控性更好。
- 油泵排量实时调节，作业时无能量损耗。变量柱塞泵具有负载敏感性及恒功率控制。

Hoist 起升机构

- Main and auxiliary winch wire ropes are 15mm in diameter and 220m in length.
- 主、副卷扬钢丝绳直径均为 15mm，长度均为 220m。

Luffing 变幅机构

- Passive luffing down with dynamic compensation. Boom angle: -2°~ 82°.
- 自重落幅，具有动态补偿机制。变幅角度：-2°~ 82°。

Safety equipment 安全装置

- Self-developed LMI.
- Hydraulic balance valve, relief valve.
- Third wrap indicator, A2B switch.
- Anemometer at boom tip.
- 三一自主研发力矩限制器。
- 液压平衡阀、溢流阀。
- 卷扬三圈保护器、高度限位器。
- 臂端风速仪。

Counterweight 配重

- 13t counterweight.
- 13t 配重。

Optional equipment at extra fees 选配

- 63t / 50t / 32t capacity hook blocks.
- Auxiliary winch.
- Auxiliary jib.
- 6 × 6 drive mode.
- Tires size 445/95R25 (6 × 4 drive).
- Fixed jib / Hydraulically adjustable jib.
- Customized painting.
- Other equipment available upon request.
- 63t, 50t, 32t 吊钩。
- 副卷扬。
- 鹅头臂。
- 6 × 6 驱动模式。
- 445/95R25 轮胎（对应 6 × 4 驱动）。
- 固定副臂 / 液压变幅副臂。
- 特殊涂装。
- 其他选配视需求定。

Working Conditions & Code Description

工况组合及工况代码说明

- T - Telescopic boom 主臂
- J - Fixed jib 固定副臂
- H - Hydraulically adjustable jib 液压变幅副臂
- A - Auxiliary jib 鹅头臂



Operating Range - T

起升高度曲线 - 主臂

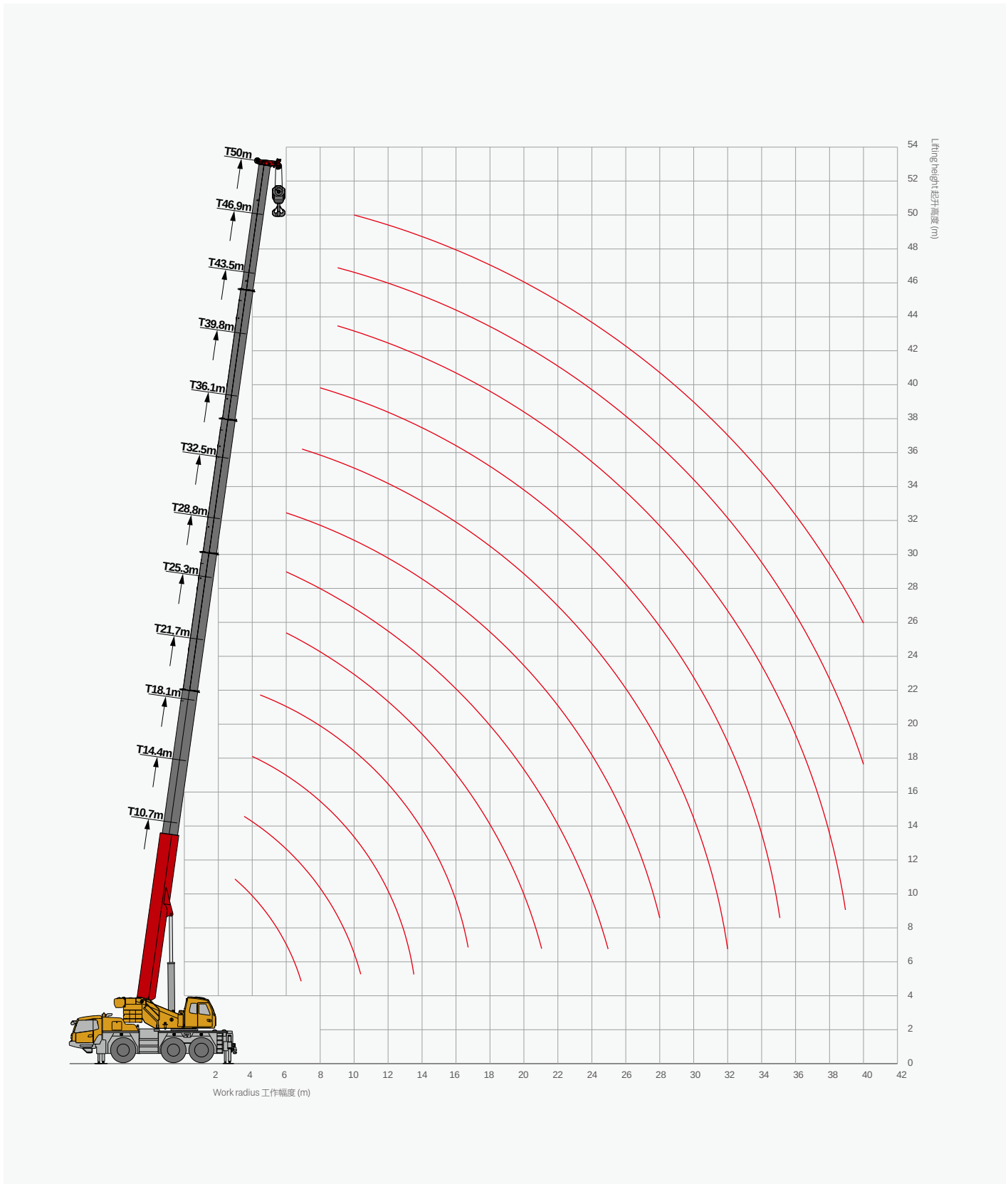

Load Chart-T

性能表 - 主臂

Unit: metric ton

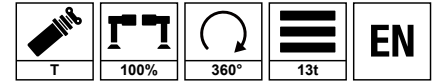

	10.7	14.4	18.1	21.7	25.3	28.8	32.5	36.1	39.8	43.5	46.9	50	
3	60*												3
3.5	50	41.7											3.5
4	46	38.7	37.7										4
4.5	42.2	36.1	35.2	35									4.5
5	37	33.9	33	32.7									5
6	28.8	28.7	29.2	28.9	27.9	24.9	20.2						6
7	22.3	23	23.3	22.3	23.7	23.4	18.2	15.9					7
8		18.6	18.9	19.2	19.3	19	16.5	15.5	12.7				8
9		15.4	15.8	16.2	16.1	15.8	15	14.9	12.5	10.2	7.8		9
10		13.1	13.5	13.9	13.8	13.5	13.8	13.1	12.1	10	7.8	6.4	10
11		11	12	12	12	12.1	12	12.2	11.4	9.7	7.7	6.4	11
12			10.5	10.6	10.4	10.8	10.7	10.7	10	9.2	7.5	6.4	12
13			9.3	9.4	9.3	9.5	9.7	9.5	9.2	8.9	7.2	6.4	13
14			8.3	8.4	8.2	8.6	8.7	8.6	8.4	8	7	6.2	14
15				7.5	7.3	7.6	7.8	7.8	7.7	7.5	6.8	6.1	15
16				6.7	6.5	6.9	7	7	6.9	6.7	6.5	6	16
17				6	6.1	6.3	6.4	6.4	6.3	6	5.8	5.8	17
18				5.5	5.7	5.7	5.8	5.8	5.6	5.5	5.2	5.3	18
19					5.3	5.2	5.3	5.3	5.2	5	4.8	4.8	19
20					4.9	4.7	4.9	4.9	4.7	4.6	4.4	4.4	20
21					4.5	4.3	4.4	4.5	4.3	4.2	3.9	4	21
22						4	4.1	4.1	3.9	3.8	3.6	3.6	22
23						3.8	3.8	3.8	3.6	3.5	3.2	3.3	23
24						3.6	3.5	3.5	3.3	3.2	3	3	24
25						3.4	3.3	3.3	3.1	2.9	2.7	2.8	25
26							3	3	2.8	2.7	2.5	2.5	26
27							2.8	2.8	2.6	2.5	2.3	2.3	27
28							2.6	2.6	2.4	2.3	2.1	2.1	28
29								2.4	2.2	2.1	1.8	1.9	29
30								2.2	2.1	1.9	1.7	1.7	30
31								2.1	1.9	1.8	1.6	1.6	31
32								1.9	1.8	1.6	1.4	1.4	32
33									1.6	1.5	1.3	1.3	33
34									1.5	1.4	1.2	1.2	34
35									1.4	1.2	1	1	35
36										1.1	0.9	0.9	36
37										1	0.8	0.8	37
38										0.9	0.7	0.7	38
39										0.8			39
40													40

rating with * indicates load over rear with additional sheaves.

*表示正后方，同时需要附加滑轮

Load Chart-T

性能表 - 主臂

Unit: metric ton



	10.7	14.4	18.1	21.7	25.3	28.8	32.5	36.1	39.8	43.5	46.9	50	
3	45												3
3.5	45	41.7											3.5
4	42.5	38.7	37.7										4
4.5	40.5	36.1	35	34									4.5
5	35	33.9	33	32									5
6	25.2	25.1	26.6	25.5	25.9	24	19.5						6
7	19.4	20.1	20.4	21	20.8	20.5	18.2	15.9					7
8		16.2	17	17.1	16.9	16.6	16.2	15.5	12.7				8
9		13.4	14.1	14.3	14.1	14.4	14.1	14	12.5	10.2	7.8		9
10		11.3	12	12.2	12	12.3	12.5	12.2	11.5	10	7.8	6.4	10
11		9.9	10.3	10.4	10.3	10.6	10.8	10.8	10.2	9.7	7.7	6.4	11
12			8.9	9	8.9	9.2	9.4	9.4	9.1	8.7	7.5	6.4	12
13			7.8	7.8	7.7	8.1	8.2	8.3	8.1	7.9	7.2	6.4	13
14			6.8	7	7.3	7.1	7.3	7.3	7.1	7	6.7	6.2	14
15				6.1	6.5	6.4	6.5	6.5	6.4	6.1	5.9	5.9	15
16				5.5	5.9	5.7	5.9	5.8	5.7	5.5	5.3	5.3	16
17				4.9	5.3	5.4	5.3	5.3	5.1	5	4.7	4.7	17
18				4.4	4.7	4.9	4.8	4.8	4.6	4.5	4.2	4.2	18
19					4.3	4.5	4.4	4.3	4.2	4	3.8	3.8	19
20					3.9	4.1	3.9	3.9	3.8	3.7	3.4	3.4	20
21					3.6	3.7	3.6	3.6	3.4	3.3	3	3.1	21
22						3.4	3.3	3.3	3.1	3	2.7	2.7	22
23						3.2	3.1	3	2.8	2.7	2.5	2.5	23
24						2.9	2.8	2.7	2.6	2.5	2.3	2.3	24
25						2.6	2.6	2.5	2.4	2.3	2	2.1	25
26							2.3	2.3	2.2	2	1.8	1.8	26
27							2.2	2.1	2	1.8	1.6	1.6	27
28							2	1.9	1.7	1.6	1.4	1.4	28
29								1.8	1.6	1.5	1.3	1.3	29
30								1.6	1.5	1.3	1.1	1.1	30
31								1.5	1.3	1.2	1	1	31
32								1.4	1.2	1.1	0.9	0.9	32
33									1.1	1	0.8	0.8	33
34									1	0.8	0.7	0.7	34
35									0.8	0.7			35



rating with * indicates load over rear with additional sheaves.
 *表示正后方, 同时需要附加滑轮

Load Chart-T

性能表 - 主臂

Unit: metric ton



	10.7	14.4	18.1	21.7	25.3	28.8	32.5	36.1	39.8	43.5	46.9	50	
3	43												3
3.5	43	41.7											3.5
4	40.1	38.7	36.9										4
4.5	37.3	36	34.5	32.8									4.5
5	30.9	30.7	31.3	31									5
6	22.2	22.9	23.2	23.9	25.2	22.9	19.5						6
7	17	17.7	18.5	18.6	19.5	18.1	17.6	15.5					7
8		14.4	14.9	15	15.8	15.3	14.9	15	12.7				8
9		11.7	12.3	12.4	12.9	12.6	12.8	12.5	11.6	10.2	7.8		9
10		9.7	10.2	10.3	10.8	10.5	10.7	10.7	10.1	9.8	7.8	6.3	10
11		8.5	8.6	8.8	9.2	9	9.2	9.2	8.8	8.8	7.7	6.3	11
12			7.5	7.5	7.9	8.1	7.8	7.9	7.7	7.5	7.2	6.3	12
13			6.5	6.5	7	7.1	7	6.9	6.7	6.5	6.2	6.3	13
14			5.6	5.7	6.2	6.2	6.2	6.1	5.9	5.7	5.5	5.5	14
15				5	5.4	5.5	5.5	5.4	5.2	5.1	4.8	4.8	15
16				4.8	4.9	5	4.8	4.8	4.7	4.5	4.2	4.3	16
17				4.3	4.3	4.5	4.4	4.3	4.2	4	3.8	3.8	17
18				3.8	4	4	3.9	3.9	3.7	3.5	3.3	3.3	18
19					3.5	3.6	3.5	3.5	3.3	3.2	2.9	2.9	19
20					3.2	3.3	3.2	3.2	3	2.8	2.6	2.6	20
21					2.9	3	2.9	2.8	2.6	2.5	2.3	2.3	21
22						2.7	2.6	2.6	2.4	2.3	2	2.1	22
23						2.5	2.4	2.3	2.2	2	1.8	1.8	23
24						2.2	2.2	2.1	2	1.8	1.6	1.6	24
25						2.1	2	1.9	1.7	1.6	1.4	1.4	25
26							1.8	1.7	1.6	1.4	1.2	1.2	26
27							1.6	1.5	1.4	1.3	1.1	1	27
28							1.5	1.4	1.2	1.1	0.9	0.9	28
29								1.2	1.1	0.9	0.7	0.8	29
30								1.1	1	0.9		0.7	30
31								1	0.9	0.7			31
32								0.9	0.7				32

rating with * indicates load over rear with additional sheaves.

*表示正后方，同时需要附加滑轮

Load Chart-T

性能表 - 主臂

Unit: metric ton



	10.7	14.4	18.1	21.7	25.3	28.8	32.5	36.1	39.8	43.5	46.9	50	
3	43												3
3.5	43	41.7											3.5
4	40.1	38.7	36.9										4
4.5	33	32.9	33.6	31.5									4.5
5	26.9	27.7	28.1	27.4									5
6	19.2	20	20.3	20.9	20.8	20.1	18.5						6
7	14.3	15.5	16.1	16.2	16	16.5	16.1	14.6					7
8		12	12.5	12.7	13.2	13	13.1	12.8	11.8				8
9		9.6	10.1	10.2	10.7	10.8	10.6	10.7	10.4	9.8	7.8		9
10		7.9	8.4	8.5	8.9	9.1	8.9	8.9	8.7	8.5	7.8	6.3	10
11		6.6	7	7.5	7.5	7.6	7.6	7.5	7.3	7.1	6.9	6.3	11
12			6	6.5	6.6	6.7	6.5	6.4	6.3	6.1	5.8	5.8	12
13			5.5	5.6	5.7	5.8	5.6	5.6	5.4	5.3	5	5	13
14			4.8	4.9	5	5.1	5	4.9	4.7	4.5	4.3	4.3	14
15				4.3	4.4	4.5	4.4	4.3	4.1	4	3.7	3.7	15
16				3.8	4	4	3.9	3.8	3.6	3.5	3.2	3.3	16
17				3.4	3.6	3.5	3.4	3.4	3.2	3	2.8	2.8	17
18				3	3.2	3.1	3	3	2.8	2.6	2.4	2.5	18
19					2.8	2.8	2.7	2.7	2.5	2.3	2.1	2.2	19
20					2.5	2.5	2.4	2.4	2.2	2.1	1.8	1.8	20
21					2.2	2.2	2.2	2.1	1.9	1.8	1.6	1.6	21
22						2	1.9	1.9	1.7	1.5	1.3	1.4	22
23						1.8	1.7	1.6	1.5	1.4	1.1	1.2	23
24						1.6	1.5	1.5	1.3	1.2	1	1	24
25						1.4	1.4	1.3	1.1	1	0.8	0.8	25
26							1.2	1.2	1	0.8	0.7	0.7	26
27							1	1	0.9	0.7			27
28							0.9	0.9	0.7				28
29								0.7					29

rating with * indicates load over rear with additional sheaves.

*表示正后方，同时需要附加滑轮

Load Chart-T

性能表 - 主臂

Unit: metric ton



	10.7	14.4	18.1	21.7	25.3	28.8	32.5	36.1	39.8	43.5	46.9	50	
3	43												3
3.5	40	41.7											3.5
4	38.7	38.7	36.9										4
4.5	32.5	32.4	33	31									4.5
5	26.5	27.3	27.7	26.6									5
6	18.9	19.6	20	20.6	20.5	19.8	18.3						6
7	14	14.8	15.8	15.9	15.8	16.2	15.8	14.4					7
8		11.8	12.3	12.4	12.9	12.7	12.8	12.8	11.6				8
9		9.4	9.9	10	10.5	10.6	10.4	10.4	10.2	9.8	7.8		9
10		7.7	8.2	8.3	8.8	8.9	8.8	8.7	8.5	8.3	7.8	6.3	10
11		6.4	6.9	7.3	7.4	7.5	7.4	7.4	7.1	7	6.7	6.3	11
12			5.9	6.3	6.4	6.5	6.3	6.3	6.1	5.9	5.7	5.7	12
13			5	5.5	5.6	5.6	5.5	5.5	5.3	5.1	4.9	4.9	13
14			4.4	4.8	4.9	4.9	4.8	4.8	4.6	4.4	4.2	4.2	14
15				4.2	4.2	4.3	4.2	4.2	4	3.9	3.6	3.7	15
16				3.7	3.8	3.8	3.7	3.7	3.5	3.3	3.1	3.1	16
17				3.2	3.4	3.4	3.4	3.3	3.1	2.9	2.7	2.7	17
18				2.9	3	3	2.9	2.9	2.7	2.6	2.4	2.4	18
19					2.7	2.7	2.7	2.5	2.4	2.3	2	2	19
20					2.4	2.4	2.3	2.3	2.1	2	1.8	1.7	20
21					2.1	2.2	2.1	2	1.9	1.7	1.5	1.5	21
22						1.9	1.9	1.8	1.6	1.5	1.3	1.3	22
23						1.8	1.6	1.6	1.4	1.3	1.1	1.1	23
24						1.5	1.5	1.4	1.3	1.1	0.9	0.9	24
25						1.4	1.3	1.2	1.1	0.9	0.7	0.8	25
26							1.2	1.1	0.9	0.8			26
27							1	1	0.8	0.7			27
28							0.9	0.8	0.7				28
29								0.7					29

rating with * indicates load over rear with additional sheaves.

*表示正后方，同时需要附加滑轮

Operating Range - TF

起升高度曲线 - 副臂

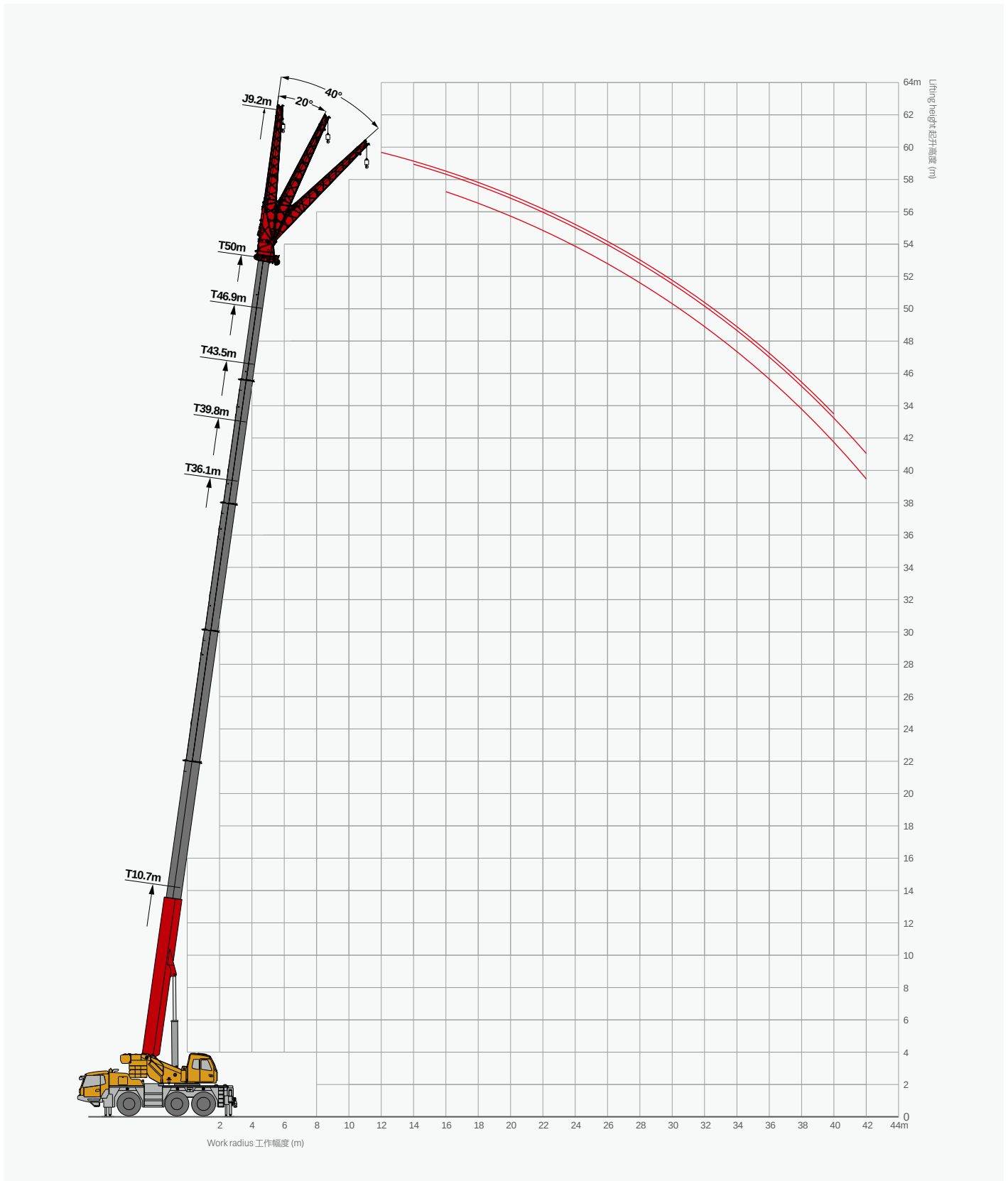

Operating Range - TJ

起升高度曲线 - 副臂

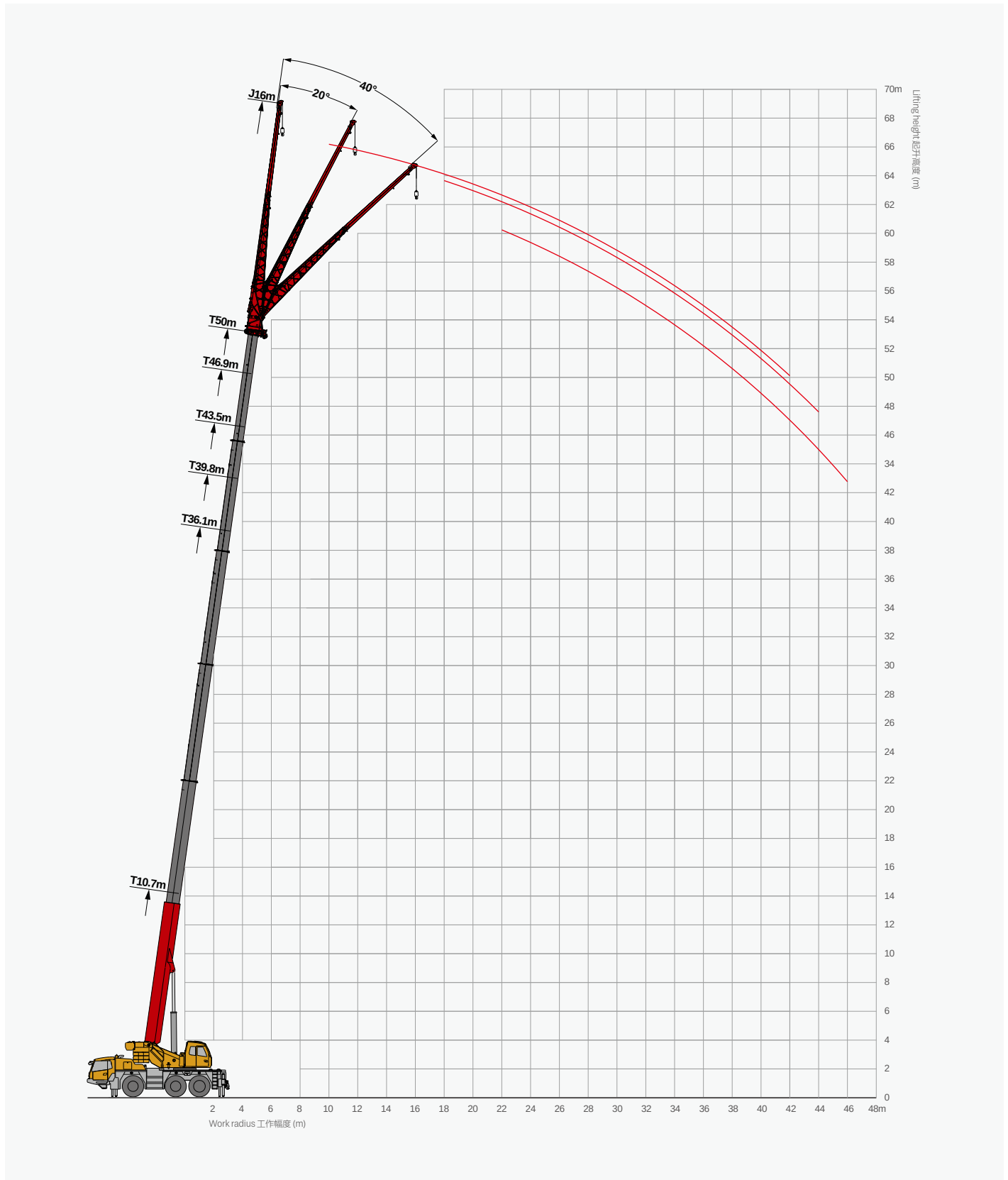

Load Chart - TJ

性能表 - 副臂

Unit: metric ton

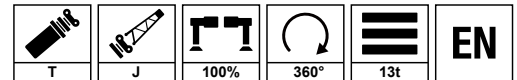

m	43.5			46.9			50			m
	9.2			9.2			9.2			
	0°	20°	40°	0°	20°	40°	0°	20°	40°	
8	5.3									8
9	5.3									9
10	5.3									10
12	5.3	5		3.9	4		3.4			12
14	5.2	4.8	4.5	3.9	3.9		3.4	3.4		14
16	5	4.7	4.3	3.8	3.8	3.6	3.4	3.4	3.3	16
18	4.8	4.5	4.2	3.7	3.6	3.5	3.3	3.3	3.2	18
20	4.5	4.2	4.1	3.6	3.5	3.3	3.2	3.2	3.1	20
22	3.9	4	3.9	3.4	3.4	3.2	3.1	3	3	22
24	3.3	3.6	3.7	3.1	3.2	3.1	2.9	2.9	2.9	24
26	2.8	3.1	3.2	2.6	2.8	3	2.6	2.8	2.8	26
28	2.4	2.6	2.8	2.2	2.4	2.6	2.2	2.4	2.6	28
30	2.1	2.3	2.4	1.8	2	2.2	1.8	1.9	2.2	30
32	1.7	1.9	1.9	1.5	1.7	1.8	1.5	1.7	1.8	32
34	1.4	1.6	1.7	1.2	1.4	1.5	1.2	1.4	1.5	34
36	1.2	1.3	1.4	1	1.1	1.3	1	1.1	1.3	36
38	1	1.2		0.8	1	1	0.8	0.9	1	38
40	0.8	0.9			0.7	0.8		0.7	0.8	40
42	0.7	0.8								42
44										44
46										46

m	39.8			43.5			46.9			50			m
	16			16			16			16			
	0°	20°	40°	0°	20°	40°	0°	20°	40°	0°	20°	40°	
8	3.5			3									8
9	3.4			3			2.6						9
10	3.4			3			2.6			2.3			10
12	3.3			3			2.6			2.3			12
14	3.2	2.8		2.9	2.7		2.6			2.3			14
16	3.2	2.8		2.9	2.6		2.5	2.4		2.2			16
18	3.1	2.7	2.3	2.8	2.5		2.5	2.3		2.2	2.2		18
20	3	2.6	2.3	2.7	2.5	2.2	2.5	2.3	2.1	2.2	2.2		20
22	2.9	2.5	2.2	2.7	2.4	2.2	2.4	2.2	2.1	2.2	2.1	2	22
24	2.8	2.4	2.2	2.6	2.3	2.2	2.4	2.2	2.1	2.1	2.1	2	24
26	2.6	2.4	2.2	2.5	2.3	2.1	2.3	2.2	2.1	2.1	2.1	2	26
28	2.2	2.3	2.1	2.5	2.2	2.1	2.3	2.1	2.1	2.1	2	2	28
30	1.8	2.2	2.1	2.2	2.2	2.1	2	2.1	2	1.9	2	2	30
32	1.5	1.8	2.1	1.8	2.2	2.1	1.6	2	2	1.6	1.9	1.9	32
34	1.3	1.6	1.7	1.6	1.8	2.1	1.4	1.7	1.9	1.4	1.6	1.9	34
36	1	1.3	1.5	1.3	1.6	1.7	1.1	1.4	1.6	1.1	1.4	1.6	36
38	0.8	1	1.2	1.2	1.4	1.5	1	1.2	1.4	0.9	1.2	1.4	38
40		0.8	1	1	1.1	1.3	0.7	1	1.1	0.7	1	1.1	40
42		0.7		0.8	0.9	1.1		0.8	0.9		0.8	0.9	42
44					0.8	0.9			0.7			0.7	44
46						0.7							46

Load Chart - TJ

性能表 - 副臂

Unit: metric ton

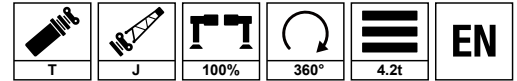

m kg	43.5			46.9			50			m kg
	9.2			9.2			9.2			
	0°	20°	40°	0°	20°	40°	0°	20°	40°	
8	5.3									8
9	5.3									9
10	5.3									10
12	5.3	5		3.9	4		3.4			12
14	4.7	4.8	4.5	3.9	3.9		3.4	3.4		14
16	3.5	4	4.3	3.3	3.8	3.6	3.3	3.4	3.3	16
18	2.8	3.1	3.5	2.5	2.9	3.3	2.5	2.9	3.2	18
20	2.2	2.5	2.8	1.9	2.3	2.6	1.9	2.3	2.6	20
22	1.7	2	2.2	1.4	1.7	2	1.4	1.8	2	22
24	1.3	1.6	1.7	1.1	1.4	1.6	1.1	1.3	1.5	24
26	1	1.2	1.4	0.8	1	1.2	0.7	1	1.2	26
28	0.7	0.9	1.1		0.7	0.9		0.7	0.9	28
30			0.8							30
32										32
34										34

m kg	39.8			43.5			46.9			50			m kg
	16			16			16			16			
	0°	20°	40°	0°	20°	40°	0°	20°	40°	0°	20°	40°	
8	3.5			3									8
9	3.4			3			2.6						9
10	3.4			3			2.6			2.3			10
12	3.3			3			2.6			2.3			12
14	3.2	2.8		2.9	2.7		2.6			2.3			14
16	3.2	2.8		2.9	2.6		2.5	2.4		2.2			16
18	2.6	2.7	2.3	2.8	2.5		2.5	2.3		2.2	2.2		18
20	1.9	2.6	2.3	2.3	2.5	2.2	2.1	2.3	2.1	2.1	2.2		20
22	1.5	2	2.2	1.8	2.4	2.2	1.6	2.2	2.1	1.6	2.1	2	22
24	1.1	1.6	2	1.4	1.9	2.2	1.2	1.7	2.1	1.2	1.6	2	24
26	0.8	1.2	1.6	1.1	1.5	1.9	0.9	1.3	1.7	0.9	1.3	1.7	26
28		0.9	1.2	0.8	1.2	1.5		1	1.4		1	1.3	28
30			0.9		0.9	1.2		0.8	1.1		0.7	1	30
32			0.7		0.7	0.9			0.8			0.8	32
34						0.7							34

Operating Range - TA

起升高度曲线 - 鹅头臂

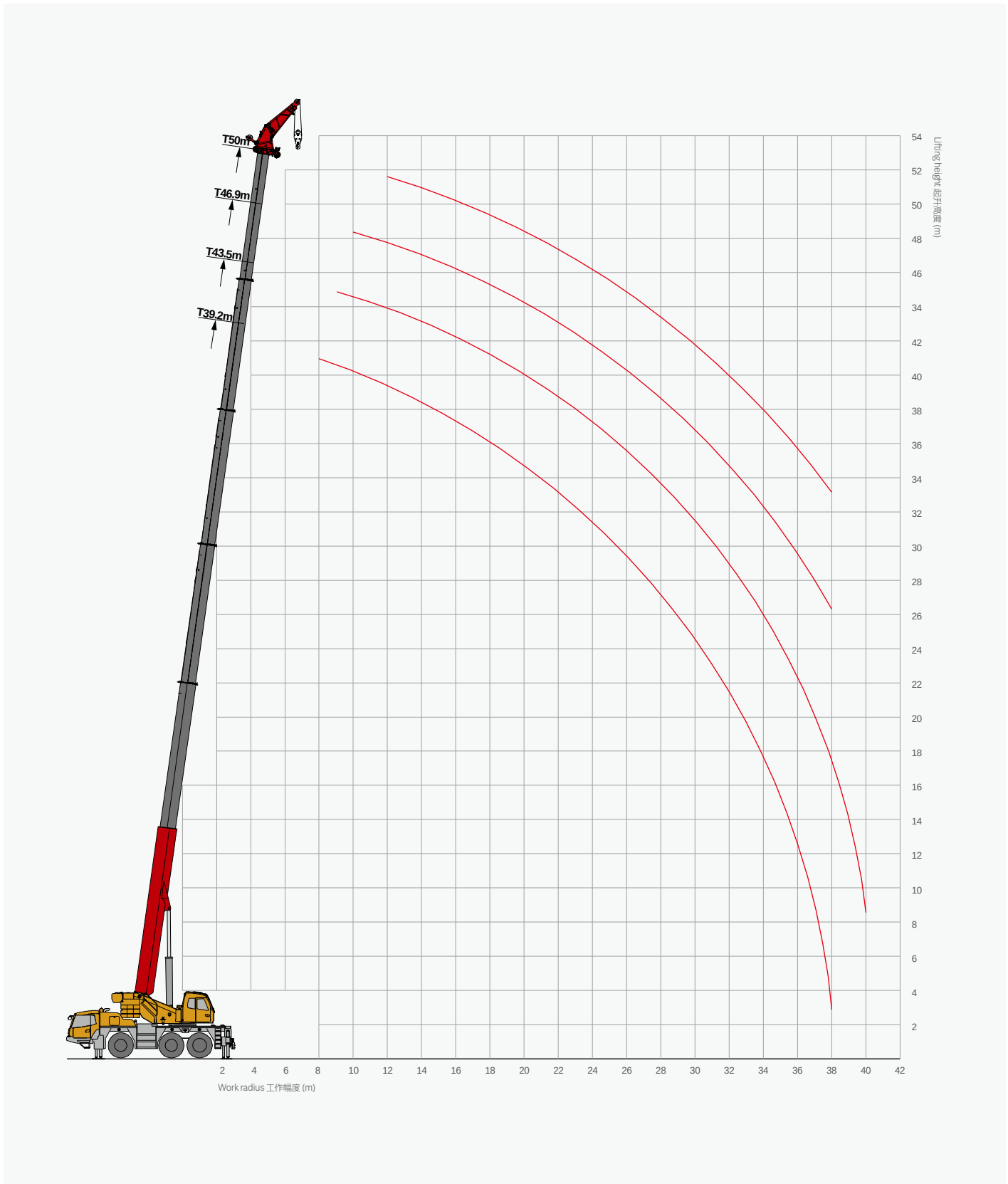



Load Chart - TA

性能表 - 鹅头臂

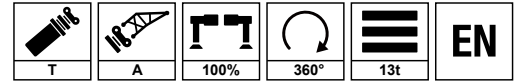
Unit: metric ton



	39.2	43.5	46.9	50	
8	9.1				8
9	8.8	7.4			9
10	8.6	7.2	6.5		10
12	7.8	6.9	6.2	5.5	12
14	7.2	6.5	6	5.3	14
16	6.5	6	5.6	5	16
18	5.5	5.5	5.3	4.8	18
20	4.9	4.7	4.9	4.4	20
22	4.2	4.2	4.2	4.1	22
24	3.7	3.6	3.5	3.5	24
26	3.2	3.1	2.9	2.9	26
28	2.7	2.6	2.4	2.4	28
30	2.3	2.2	2.2	2	30
32	2	1.8	1.9	1.6	32
34	1.7	1.5	1.6	1.3	34
36	1.4	1.2	1.3	1	36
38	1.2	1	1	0.8	38
40		0.8			40

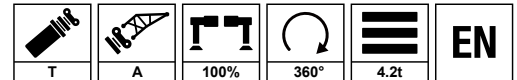

Unit: metric ton

	39.2	43.5	46.9	50	
8	9.1				8
9	8.8	7.4			9
10	8.6	7.2	6.5		10
12	7.5	6.9	6.2	5.5	12
14	5.6	5.4	5.2	5.2	14
16	4.3	4.2	3.9	3.9	16
18	3.4	3.2	3	3	18
20	2.6	2.5	2.2	2.2	20
22	2.1	1.9	1.7	1.6	22
24	1.6	1.4	1.2	1.2	24
26	1.2	1	0.8	0.8	26
28	0.9	0.7			28



SANY GROUP CRANE BU

SANY Mobile Crane Industrial Park, No.168 Jinzhou Avenue, Jinzhou Development Zone, Changsha City,
Hunan Province, P.R. China Zip 410600
Consulting sanycrane@sanygroup.com (Crane BU) / crd@sany.com.cn (IHQ)
After-sales Service 0086-400 6098 318

Reminder:

Any change in the technical parameters and configuration due to product modification or upgrade may occur without prior notice.
The machine in the picture may include additional equipment. This brochure is for reference only, and goods in kind shall prevail.
Copyright at SANY. No part of this brochure may be copied or used for any purpose without written approval from SANY.

© Edited in December 2022

三一集团起重事业部

中国湖南长沙金洲开发区金洲大道 168 号 三一汽车起重机产业园 邮编: 410600
咨询: sanycrane@sanygroup.com (起重事业部) / crd@sany.com.cn (国际总部)
海外售后服务: 0086-400 6098 318

温馨提示:

由于技术不断更新, 技术参数及配置如有更改, 恕不另行通知。图中机器可能包括附加设备, 本画册仅供参考, 以实物为准。
版权为三一所有, 未经三一书面许可, 本画册任何内容不得被复制用于任何目的。

© 2022 年 12 月版

